

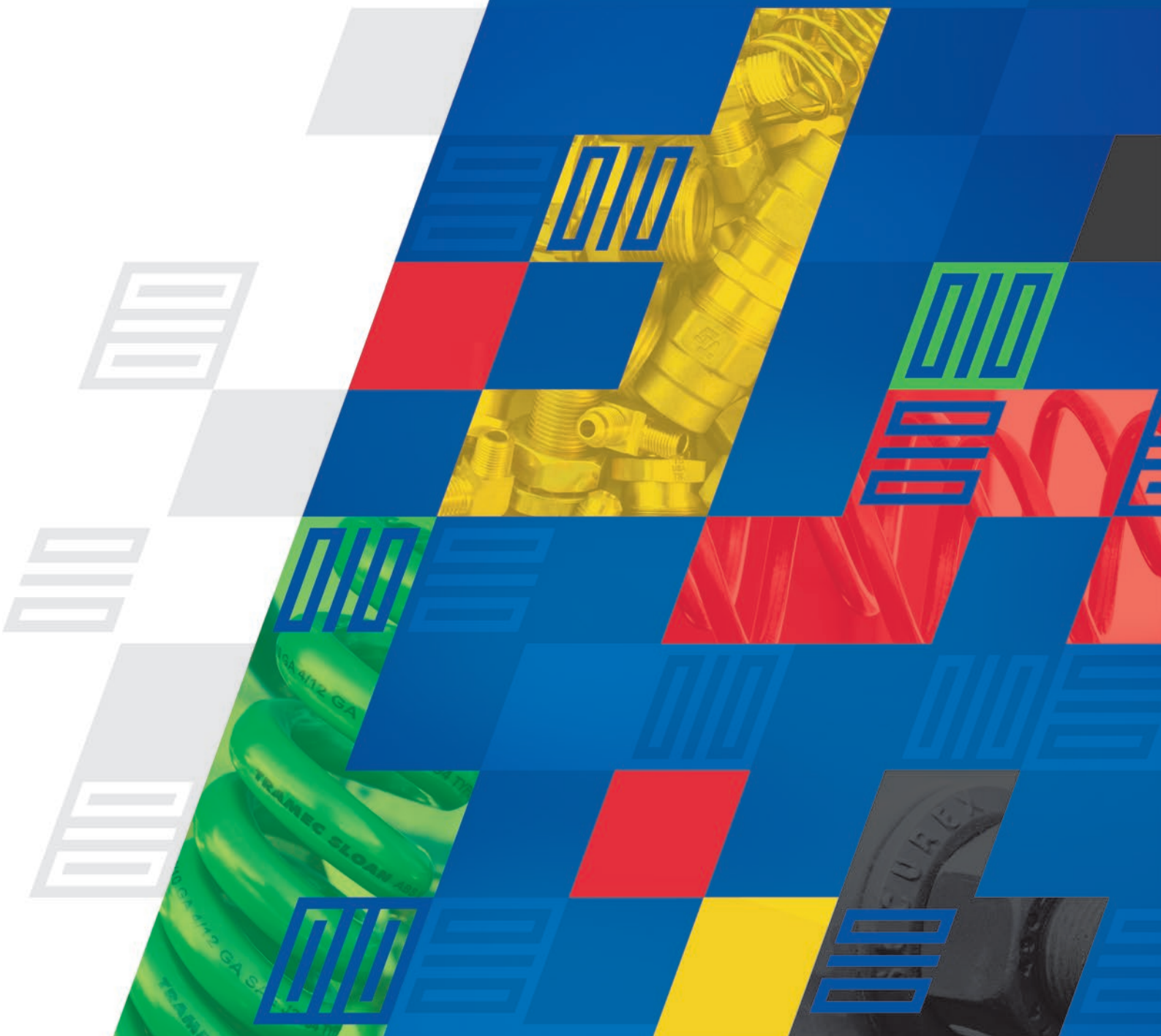

FULL LINE CATALOG

800.336.7778
TRAMECSLOAN.COM





**HOSE ASSEMBLIES
PAGE 29**



**GLADHANDS
PAGE 48**



**COILED AIR
PAGE 20**



**DRAIN VALVES
PAGE 87**

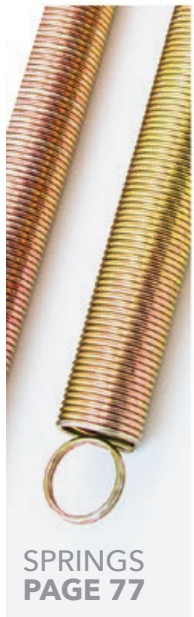

**SPRINGS
PAGE 77**



**MAXXCLAMPS
PAGE 74**



**3-IN-1 &
4-IN-1 WRAPS
PAGE 6**



**BULK HOSE
PAGE 28**



**AIR BRAKE
VALVES
PAGE 95**



**AIR TANKS
PAGE 82**



**BULK
NYLON
TUBING
PAGE 26**

AIR PRODUCTS 4

- 3-in-1 Wraps.....6
- 4-in-1 Wraps.....9
- 3-in-1 MAXXWraps™12
- Tractor-to-Trailer Hose Assemblies14
- Coiled Air20
- Nylon Air Brake Tubing26
- Bulk Hose28
- Rubber Hose Assemblies.....29
- Air Compressor Discharge Hose45
- Anodized Gladhands49
- Knob-Style Shutoff Gladhands.....50
- Anodized Swivel Gladhands51
- Rapid-Release™ Service Gladhands.....52
- Standard Gladhands53
- Cast Iron Gladhands55
- Swing-Away Gladhands.....56
- Angled Gladhands60
- Pull-Lever Style Gladhands.....63
- MAXXGrip™ Gladhands64
- Gladhand Accessories67
- Dummy Gladhands69
- Gladhand Seals.....70
- Pogo Sticks.....72
- Tracker Bars & Tender Kits.....76
- Springs77
- Hose Clamps & Spacers78
- Air Tanks82
- Drain Valves87
- Dash Control Valves90
- Air Brake Valves95
- Air Accessory Valves109
- Control Boxes112
- Air Cylinders119

TABLE OF CONTENTS

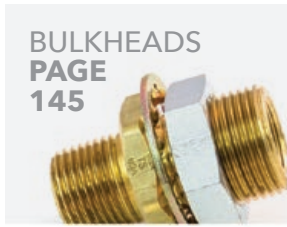

**BULKHEADS
PAGE
145**



**COMPOSITE
PUSH-TO-CONNECTS
PAGE 135**



**NYLON
TUBE FITTINGS
PAGE 128**



**RUBBER HOSE
FITTINGS
PAGE 139**



**QUICK-FIX® KITS
PAGE 122**



**FASTENERS
PAGE 196**



**SONOGRIP® CABLES
PAGE 206**



**PIPE
FITTINGS
PAGE
150**



**ABS
CABLES
PAGE 212**



**SMART BOX®
PAGE 228**



**PLUGS
PAGE 224**

FITTINGS & FASTENERS 120

- Quick-Fix® Kits 122
- Nylon Tube Fittings 128
- Brass D.O.T. Push-In Fittings 131
- Composite D.O.T. Push-In Fittings 135
- Rubber Air Brake Hose Fittings 139
- Copper Air Brake Tube Fittings 142
- Bulkhead Fittings 145
- Transmission Fittings 149
- Pipe Fittings 150
- 45° Flare Fittings 156
- Inverted Flare Fittings 163
- Compression Fittings 166
- Captive Sleeve Compression Fittings 170
- Hose Barbs 172
- Low-Pressure, Push-On Hose Barbs 175
- Garden Hose Fittings 177
- Grease Fittings 180
- Truck & Ball Valves 182
- Drain Cocks & Shut-Off Valves 184
- Lead Free Fittings 187
- PTFE Fittings 190
- Tube & Thread Charts 191
- Bin Assortments 192
- Grade 8 Fasteners 196

ELECTRICAL 204

- Sonogrip® ABS Cables 206
- ABS Cables 212
- Sonogrip® Standard Cables 216
- Standard Cables 218
- Single & Dual Pole Cables 220
- Plugs 224
- Smart Box® Receptacles 228
- 30-Pin Receptacles 232

Nylon Receptacles.....	233
Zinc Receptacles.....	237
Junction Boxes	241
Bulk Wire & Cable	242
Electrical Harnesses	250
Electrical Connectors.....	254
Heat Shrink Tubing	259
Battery Terminals	261
Power Terminals.....	263
Power Lugs & Splices	265
Battery Cables.....	267
Circuit Breakers	268
Fuses.....	270
Tools & Kits.....	272
Switches & Toggles	276
AND MORE	284
MAXXValue™ Wiper Blades.....	286
Michelin Wiper Blades.....	288
Water Pumps.....	291
Dipsticks.....	316
Oil Caps.....	317
Engine Heaters	318
Hose Clamps.....	325
Diesel Anti-Siphon Devices.....	329
Fuel Caps.....	330
Wheel Nuts.....	334
Hub Caps.....	336
Document Holders.....	337
Tarp Straps	337
U-Bolt Kits.....	338
End Threaded Rod	339
INDEX	340
INSTALLATION GUIDES	365



WIRE & CABLE
PAGE 242



JUNCTION
BOXES
PAGE 241



RECEPTACLES
PAGE 232



CONNECTORS
PAGE 254

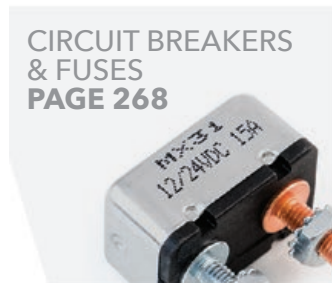

CIRCUIT BREAKERS
& FUSES
PAGE 268



TERMINALS
PAGE 261



HOSE CLAMPS
PAGE 325



SWITCHES
PAGE 276

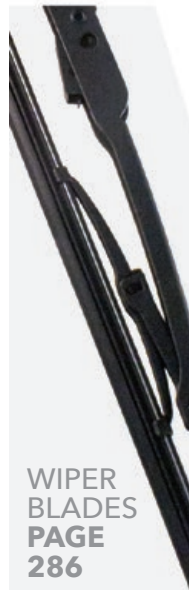

WIPER
BLADES
PAGE
286

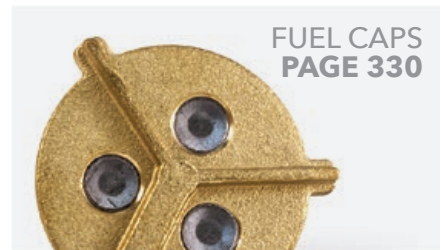

FUEL CAPS
PAGE 330



WATER PUMPS
PAGE 291

AIR PRODUCTS

MANUFACTURING IN THE UNITED STATES

For more than 40 years, air products have been at the core of who Tramec Sloan is. That is why every one of our manufacturing plants plays a part in making the vast majority of these products right here in the United States.

From our invention of the Composite Swivel Hose Assembly (pages 34-35), to our popular Trailer Emergency Valve (pages 103-104) and innovative gladhand designs (pages 45-63), Tramec Sloan has been at the forefront of the Heavy Duty air product industry.

We are often imitated but never duplicated. This innovation, dedication to service and our American Made quality has made Tramec Sloan a trusted industry leader to the Heavy Duty Vehicle market.

QUALITY | DELIVERY | PERFORMANCE | VALUE



IN THIS SECTION:

PRODUCT	PAGE	
3-in-1 Wraps.....	6	Angled Gladhands
4-in-1 Wraps.....	9	Pull-Lever Style Gladhands.....
3-in-1 MAXXWraps™	12	MAXXGrip™ Gladhands
Tractor-to-Trailer Hose Assemblies	14	Gladhand Accessories
Coiled Air	20	Dummy Gladhands
Nylon Air Brake Tubing	26	Gladhand Seals.....
Bulk Hose	28	Pogo Sticks.....
Rubber Hose Assemblies.....	29	Tracker Bars & Tender Kits
Air Compressor Discharge Hose	45	Springs
Anodized Gladhands	49	Hose Clamps & Spacers
Knob-Style Shutoff Gladhands.....	50	Air Tanks
Anodized Swivel Gladhands	51	Drain Valves
Rapid-Release Service Gladhands.....	52	Dash Control Valves
Standard Gladhands	53	Air Brake Valves
Cast Iron Gladhands	55	Air Accessory Valves
Swing-Away Gladhands.....	56	Control Boxes
		Air Cylinders



3-IN-1 & 4-IN-1 WRAPS

PROVIDING THE MOST DIVERSE OPTIONS & CUSTOMIZATIONS IN THE INDUSTRY

Tramec Sloan's 3-in-1 & 4-in-1 Wraps are **manufactured in the USA** at our facility in Holland, MI, using components made at each of our three manufacturing plants. Because of this, we're able to provide customers with the precise combination of features they require.

DO YOU HAVE A NON-STANDARD NEED? WE CAN CREATE YOUR SOLUTION!

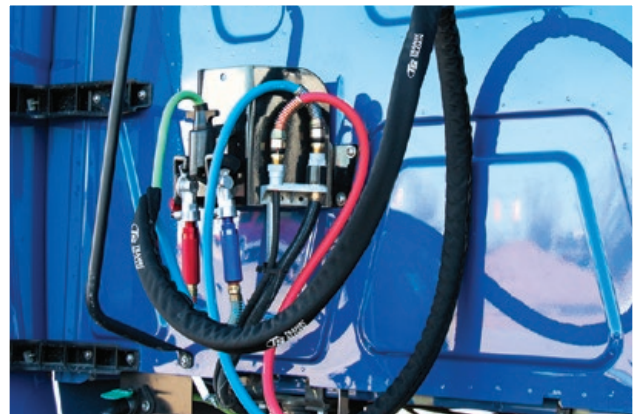

CUSTOMIZE YOUR WRAP!

Tramec Sloan's 3-in-1 & 4-in-1 Wraps come standard using 3/8" hose assemblies with 1/2" adapter swivel fittings & springs, hanger clamp, carabiner and sleeve.

YOU CHOOSE:

Overall Length: Any Length You Require! 12', 13.5', 15', & 20' are Standard

Hose Color: Black or Red & Blue

ABS Cable: Premium Sonogrip, Heavy Duty with Zinc Plugs, or Economy

Other Cables: Yellow ISO, Single Pole, Horizontal or Vertical Dual Pole

Gladhands/Handles: Three MAXXGrip Gladhand Options: Aluminum, Powder-Coated & Anodized, Plastic Dura-Grips, Aluminum Grips, or Fittings Only

Wrap Style: Standard Spiral Wrap or Tramec Sloan's **NEW** MAXXWrap



PICTURED: 3-in-1 Wrap #451098

3-IN-1 WRAPS WITH BLACK HOSES

- **American Made!** Hoses, Cables, and Completed Wrap Assembly are All Made in the USA
- Two 3/8" Rubber Hoses Feature 1/2" Adapter Swivel Fittings with Springs
- Combines Components into One Tight Bundle
- Keeps Power Lines from Becoming Tangled
- Wraps Provide Superior Abrasion Resistance

P/N	LENGTH	HANDLE TYPE	ELECTRICAL CABLE
451097	12 ft.	Dura-Grip	Heavy Duty 7-Way ABS with Green Jacket & Zinc Plugs
451098	15 ft.	Dura-Grip	Heavy Duty 7-Way ABS with Green Jacket & Zinc Plugs
451099	20 ft.	Dura-Grip	Heavy Duty 7-Way ABS with Green Jacket & Zinc Plugs
451107	12 ft.	Dura-Grip	Economy 7-Way with Black Jacket
451108	15 ft.	Dura-Grip	Economy 7-Way with Black Jacket
451114	6 ft.	None	Economy 7-Way with Black Jacket
451198	10 ft.	Aluminum Grips	Heavy Duty 7-Way ABS with Green Jacket & Zinc Plugs
451119	12 ft.	Aluminum Grips	Heavy Duty 7-Way ABS with Green Jacket & Zinc Plugs
451274	13.5 ft.	Aluminum Grips	Heavy Duty 7-Way ABS with Green Jacket & Zinc Plugs
451120	15 ft.	Aluminum Grips	Heavy Duty 7-Way ABS with Green Jacket & Zinc Plugs
451121	20 ft.	Aluminum Grips	Heavy Duty 7-Way ABS with Green Jacket & Zinc Plugs
451183	12 ft.	Aluminum MAXXGrips	Heavy Duty 7-Way ABS with Green Jacket & Zinc Plugs
451184	15 ft.	Aluminum MAXXGrips	Heavy Duty 7-Way ABS with Green Jacket & Zinc Plugs
451185	20 ft.	Aluminum MAXXGrips	Heavy Duty 7-Way ABS with Green Jacket & Zinc Plugs
451186	12 ft.	Powder-Coated MAXXGrips	Heavy Duty 7-Way ABS with Green Jacket & Zinc Plugs
451187	15 ft.	Powder-Coated MAXXGrips	Heavy Duty 7-Way ABS with Green Jacket & Zinc Plugs
451188	20 ft.	Powder-Coated MAXXGrips	Heavy Duty 7-Way ABS with Green Jacket & Zinc Plugs
451201	12 ft.	Powder-Coated MAXXGrips	Sonogrip® ABS Cable with Straight & Angled Ends
451202	15 ft.	Powder-Coated MAXXGrips	Sonogrip® ABS Cable with Straight & Angled Ends

3-IN-1 & 4-IN-1 WRAPS



PICTURED:
3-in-1 Wrap #451204



SONOGrip® ABS:
Learn More About Our
Innovative Cable on Page 206

3-IN-1 WRAPS WITH RED & BLUE HOSES

- **American Made!** Hoses, Cables, and Completed Wrap Assembly are All Made in the USA
- Identify Your Air Lines at a Glance with Red & Blue Hoses
- Two 3/8" Rubber Hoses Feature 1/2" Adapter Swivel Fittings with Springs
- Combines Components into One Tight Bundle
- Keeps Power Lines from Becoming Tangled
- Wraps Provide Superior Abrasion Resistance

P/N	LENGTH	HANDLE TYPE	ELECTRICAL CABLE
451180	12 ft.	Dura-Grip	Heavy Duty 7-Way ABS with Green Jacket & Zinc Plugs
451181	15 ft.	Dura-Grip	Heavy Duty 7-Way ABS with Green Jacket & Zinc Plugs
451182	20 ft.	Dura-Grip	Heavy Duty 7-Way ABS with Green Jacket & Zinc Plugs
451189	12 ft.	Aluminum MAXXGrips	Heavy Duty 7-Way ABS with Green Jacket & Zinc Plugs
451190	15 ft.	Aluminum MAXXGrips	Heavy Duty 7-Way ABS with Green Jacket & Zinc Plugs
451191	20 ft.	Aluminum MAXXGrips	Heavy Duty 7-Way ABS with Green Jacket & Zinc Plugs
451192	12 ft.	Powder-Coated MAXXGrips	Heavy Duty 7-Way ABS with Green Jacket & Zinc Plugs
451193	15 ft.	Powder-Coated MAXXGrips	Heavy Duty 7-Way ABS with Green Jacket & Zinc Plugs
451194	20 ft.	Powder-Coated MAXXGrips	Heavy Duty 7-Way ABS with Green Jacket & Zinc Plugs
451204	12 ft.	Powder-Coated MAXXGrips	Sonogrip® ABS Cable with Straight & Angled Ends
451275	13.5 ft.	Powder-Coated MAXXGrips	Sonogrip® ABS Cable with Straight & Angled Ends
451205	15 ft.	Powder-Coated MAXXGrips	Sonogrip® ABS Cable with Straight & Angled Ends
451206	20 ft.	Powder-Coated MAXXGrips	Sonogrip® ABS Cable with Straight & Angled Ends



PICTURED:
4-in-1 Wrap #451124



4-IN-1 WRAPS WITH BLACK HOSES

- **American Made!** Hoses, Cables, and Completed Wrap Assembly are All Made in the USA
- Two 3/8" Rubber Hoses Feature 1/2" Adapter Swivel Fittings with Springs
- One 7-Way ABS Electrical Cable, and One ISO Cord or Liftgate Cable
- Combines Components into One Tight Bundle
- Keeps Power Lines from Becoming Tangled
- Wraps Provide Superior Abrasion Resistance

P/N	LENGTH	HANDLE TYPE	CABLE 1	CABLE 2
451122	12 ft.	Dura-Grip	Heavy Duty 7-Way ABS	Yellow ISO Cable
451123	15 ft.	Dura-Grip	Heavy Duty 7-Way ABS	Yellow ISO Cable
451124	12 ft.	Aluminum Grips	Heavy Duty 7-Way ABS	Yellow ISO Cable
451125	15 ft.	Aluminum Grips	Heavy Duty 7-Way ABS	Yellow ISO Cable
451129	12 ft.	Dura-Grip	Heavy Duty 7-Way ABS	Single Pole Liftgate Cable
451130	15 ft.	Dura-Grip	Heavy Duty 7-Way ABS	Single Pole Liftgate Cable
451131	20 ft.	Dura-Grip	Heavy Duty 7-Way ABS	Single Pole Liftgate Cable
451139	12 ft.	Dura-Grip	Heavy Duty 7-Way ABS	Dual Pole Liftgate Cable
451140	15 ft.	Dura-Grip	Heavy Duty 7-Way ABS	Dual Pole Liftgate Cable
451141	20 ft.	Dura-Grip	Heavy Duty 7-Way ABS	Dual Pole Liftgate Cable
451149	12 ft.	Aluminum Grips	Heavy Duty 7-Way ABS	Single Pole Liftgate Cable
451150	15 ft.	Aluminum Grips	Heavy Duty 7-Way ABS	Single Pole Liftgate Cable
451151	20 ft.	Aluminum Grips	Heavy Duty 7-Way ABS	Single Pole Liftgate Cable
451159	12 ft.	Aluminum Grips	Heavy Duty 7-Way ABS	Dual Pole Liftgate Cable
451160	15 ft.	Aluminum Grips	Heavy Duty 7-Way ABS	Dual Pole Liftgate Cable
451161	20 ft.	Aluminum Grips	Heavy Duty 7-Way ABS	Dual Pole Liftgate Cable

3-IN-1 & 4-IN-1 WRAPS



PICTURED:
4-in-1 Wrap #451266

4-IN-1 WRAPS WITH RED & BLUE HOSES

- **American Made!** Hoses, Cables, and Completed Wrap Assembly are All Made in the USA
- Identify Your Air Lines at a Glance with Red & Blue Hoses
- Two 3/8" Rubber Hoses Feature 1/2" Adapter Swivel Fittings with Springs
- One 7-Way ABS Electrical Cable, and One ISO Cord or Liftgate Cable
- Combines Components into One Tight Bundle
- Keeps Power Lines from Becoming Tangled
- Wraps Provide Superior Abrasion Resistance

P/N	LENGTH	HOSES	HANDLE TYPE	CABLE 1	CABLE 2
451257	12 ft.	Red & Blue	Powder-Coated MAXXGrips	Sonogrip® ABS	Single Pole Liftgate Cable
451258	15 ft.	Red & Blue	Powder-Coated MAXXGrips	Sonogrip® ABS	Single Pole Liftgate Cable
451279	20 ft.	Red & Blue	Powder-Coated MAXXGrips	Sonogrip® ABS	Single Pole Liftgate Cable
451259	12 ft.	Red & Blue	Powder-Coated MAXXGrips	Sonogrip® ABS	Horizontal Dual Pole Cable
451260	15 ft.	Red & Blue	Powder-Coated MAXXGrips	Sonogrip® ABS	Horizontal Dual Pole Cable
451280	20 ft.	Red & Blue	Powder-Coated MAXXGrips	Sonogrip® ABS	Horizontal Dual Pole Cable
451266	12 ft.	Red & Blue	Powder-Coated MAXXGrips	Sonogrip® ABS	Yellow ISO Cable
451267	15 ft.	Red & Blue	Powder-Coated MAXXGrips	Sonogrip® ABS	Yellow ISO Cable
451281	20 ft.	Red & Blue	Powder-Coated MAXXGrips	Sonogrip® ABS	Yellow ISO Cable

DON'T SEE THE CONFIGURATION YOU NEED?

No Problem! Give Customer Service a Call and We'll Make it for You in Just 48 Hours!

HANGER CLAMP

P/N	DESCRIPTION
451089	3-in-1 Power/Air Line Hanger Clamp

CARABINER

P/N	DESCRIPTION
451096	Carabiner

BULK SPIRAL WRAP

P/N	DESCRIPTION
451106*	1.14" Diameter Spiral Wrap - 100'
451116	1.5" Diameter Spiral Wrap - 100'
451117	2" Diameter Spiral Wrap - 100'
451118	3" Diameter Spiral Wrap - 100'

* Used in Tramec Sloan's Own 3-in-1 and 4-in-1 Wraps



TS TECH TIP:

Avoid damage & CSA violations! Utilize multiple tender springs to hang your wrapped lines instead of just one. This will reduce stress on the springs so they won't stretch out and drag your lines on the deck plate.

THE MAXXWRAP™

Custom Create Your Own 3-in-1 Wraps with this Durable & Innovative New Way to Protect Your Vital Lines!



Tramec Sloan's new MAXXWrap provides a durable way to bundle your air and electrical lines. Made from tightly woven ballistic nylon, the MAXXWrap is flexible, repels liquid, and prevents damage from tangling, abrasion, gasoline, engine chemicals, salt spray, and more!

MAXXWRAP™ FEATURES & BENEFITS:

- **Made in the USA!**
- Developed with and Tested by a Major US & Canadian Fleet to Meet Your All-Weather Needs!
- The MAXXWrap Makes it Simple to Repair & Replace Your Air & Electrical Lines Whenever Needed
- Lines Can Be Easily Unwrapped for DOT Inspection
- Custom Create any Combination of Hose and Electrical Lines!
- Less SKUs to Stock



THE MAXXWRAP™

P/N	DESCRIPTION
451208	Bulk MAXXWrap - 150' Roll*
451209	MAXXWrap for 12' Assembly (Actual Length 7.8')
451210	MAXXWrap for 15' Assembly (Actual Length 11.7')
451211	MAXXWrap for 20' Assembly (Actual Length 16.7')

*Tramec Sloan suggests the best way to cut bulk MAXXWrap is to use a heat knife.

It can also be sheared but it's recommended to seal with heat afterwards to avoid fraying.

BUILD YOUR OWN TRAMEC SLOAN 3-IN-1!

See Pages 14-17 & 30-43 for Hose Assemblies and Pages 206-223 for Cables



PICTURED:
3-in-1 MAXXWrap
#451223

3-IN-1 MAXXWRAP™ ASSEMBLIES

- Combines Components into One Sleek, Tight Bundle with the MAXXWrap.
- MAXXWrap Prevents Damage from Tangling, Road & Engine Chemicals, and More!
- **American Made!** Hoses, Cables, and Completed Wrap Assembly are All Made in the USA
- Two 3/8" Rubber Hoses Feature 1/2" Adapter Swivel Fittings with Springs

P/N	LENGTH	HANDLE TYPE	HOSES	CABLE
451212	12 ft.	Alum. Grips + Anodized Gladhands	Red & Blue	Sonogrip® ABS, Straight & Angled Ends
451213	15 ft.	Alum. Grips + Anodized Gladhands	Red & Blue	Sonogrip® ABS, Straight & Angled Ends
451215	12 ft.	Aluminum Grips	Red & Blue	Sonogrip® ABS, Straight & Angled Ends
451216	15 ft.	Aluminum Grips	Red & Blue	Sonogrip® ABS, Straight & Angled Ends
451221	12 ft.	Dura-Grip	Black	Heavy Duty 7-Way ABS, Zinc Plugs
451222	15 ft.	Dura-Grip	Black	Heavy Duty 7-Way ABS, Zinc Plugs
451223	12 ft.	Powder-Coated MAXXGrips	Red & Blue	Heavy Duty 7-Way ABS, Zinc Plugs
451224	15 ft.	Powder-Coated MAXXGrips	Red & Blue	Heavy Duty 7-Way ABS, Zinc Plugs
451226	12 ft.	Anodized MAXXGrips	Black	Sonogrip® ABS, Straight & Angled Ends
451227	15 ft.	Anodized MAXXGrips	Black	Sonogrip® ABS, Straight & Angled Ends
451228	12 ft.	Cast Iron Gladhands	Red & Blue	Sonogrip® ABS, Straight & Angled Ends
451231	20 ft.	Anodized MAXXGrips	Black	Sonogrip® ABS, Straight & Angled Ends
451232	12 ft.	Anodized MAXXGrips	Red & Blue	Sonogrip® ABS, Straight & Angled Ends
451233	15 ft.	Anodized MAXXGrips	Red & Blue	Sonogrip® ABS, Straight & Angled Ends
451234	20 ft.	Anodized MAXXGrips	Red & Blue	Sonogrip® ABS, Straight & Angled Ends
451235	8 ft.	Anodized MAXXGrips	Black	Sonogrip® ABS, Straight & Angled Ends
451236	10 ft.	Anodized MAXXGrips	Black	Sonogrip® ABS, Straight & Angled Ends
451237	8 ft.	Anodized MAXXGrips	Red & Blue	Sonogrip® ABS, Straight & Angled Ends
451238	10 ft.	Anodized MAXXGrips	Red & Blue	Sonogrip® ABS, Straight & Angled Ends
451239	8 ft.	Anodized MAXXGrips	Black	Sonogrip® ABS, Straight Ends
451240	10 ft.	Anodized MAXXGrips	Black	Sonogrip® ABS, Straight Ends
451241	8 ft.	Anodized MAXXGrips	Red & Blue	Sonogrip® ABS, Straight Ends
451242	10 ft.	Anodized MAXXGrips	Red & Blue	Sonogrip® ABS, Straight Ends



TRACTOR-TO-TRAILER HOSE ASSEMBLIES

- High-Quality and **American Made!**
- Minimum Burst Pressure of 900 PSI
- Conforms to SAE J1402 & DOT-106 Specs
- Maximum Operating Pressure of 225 PSI
- Operating Temperature of -40°F to +212°F
- Hoses are Resistant to Gasoline, Diesel Fuel, Oil, and Other Commonly Used Road & Cleaning Chemicals
- One End of Each Assembly Features an Adapter Swivel Fitting
- Excellent Abrasion Resistance

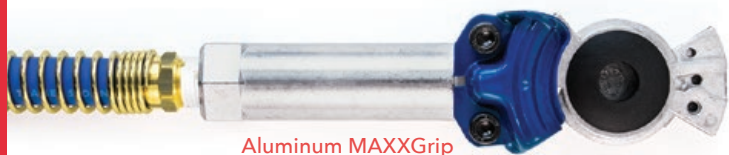

Aluminum MAXXGrip



Aluminum Grip



Anodized MAXXGrip



Powder-Coated MAXXGrip



Dura-Grip

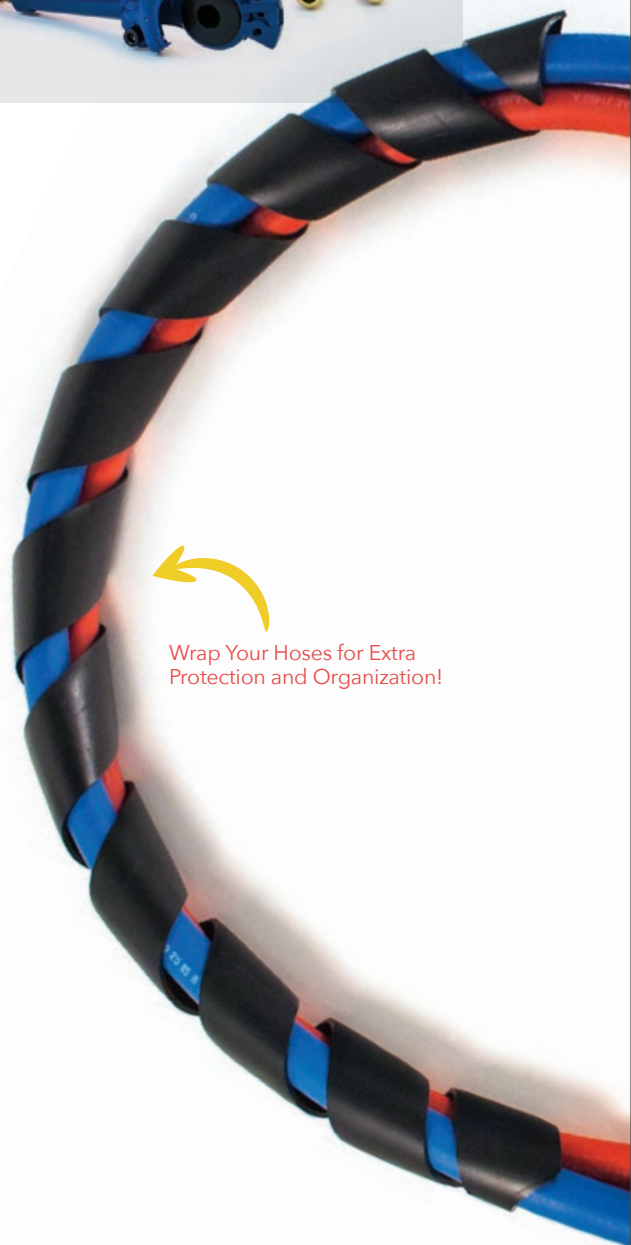

Wrap Your Hoses for Extra Protection and Organization!

LEARN ABOUT THE MAXXGRIP™ ON PAGE 65!



TRACTOR-TO-TRAILER ASSEMBLIES – BLACK HOSE

P/N	HOSE	LENGTH	HANDLE TYPE
455144	3/8" Black Hoses	12 ft.	None
455180	3/8" Black Hoses	15 ft.	None
455240	3/8" Black Hoses	20 ft.	None
455144B	3/8" Black Hoses	12 ft.	Blue Dura-Grip
455144R	3/8" Black Hoses	12 ft.	Red Dura-Grip
455180B	3/8" Black Hoses	15 ft.	Blue Dura-Grip
455180R	3/8" Black Hoses	15 ft.	Red Dura-Grip
455240B	3/8" Black Hoses	20 ft.	Blue Dura-Grip
455240R	3/8" Black Hoses	20 ft.	Red Dura-Grip
455144AB	3/8" Black Hoses	12 ft.	Blue Aluminum Grip
455144AR	3/8" Black Hoses	12 ft.	Red Aluminum Grip
455180AB	3/8" Black Hoses	15 ft.	Blue Aluminum Grip
455180AR	3/8" Black Hoses	15 ft.	Red Aluminum Grip
455240AB	3/8" Black Hoses	20 ft.	Blue Aluminum Grip
455240AR	3/8" Black Hoses	20 ft.	Red Aluminum Grip
455144BMAXX	3/8" Black Hoses	12 ft.	Blue Aluminum MAXXGrip Gladhand
455144RMAXX	3/8" Black Hoses	12 ft.	Red Aluminum MAXXGrip Gladhand
455180BMAXX	3/8" Black Hoses	15 ft.	Blue Aluminum MAXXGrip Gladhand
455180RMAXX	3/8" Black Hoses	15 ft.	Red Aluminum MAXXGrip Gladhand
455240BMAXX	3/8" Black Hoses	20 ft.	Blue Aluminum MAXXGrip Gladhand
455240RMAXX	3/8" Black Hoses	20 ft.	Red Aluminum MAXXGrip Gladhand
455144PBMAXX	3/8" Black Hoses	12 ft.	Blue Powder-Coated MAXXGrip Gladhand
455144PRMAXX	3/8" Black Hoses	12 ft.	Red Powder-Coated MAXXGrip Gladhand
455180PBMAXX	3/8" Black Hoses	15 ft.	Blue Powder-Coated MAXXGrip Gladhand
455180PRMAXX	3/8" Black Hoses	15 ft.	Red Powder-Coated MAXXGrip Gladhand
455240PBMAXX	3/8" Black Hoses	20 ft.	Blue Powder-Coated MAXXGrip Gladhand
455240PRMAXX	3/8" Black Hoses	20 ft.	Red Powder-Coated MAXXGrip Gladhand

DON'T SEE THE CONFIGURATION YOU NEED?

No Problem! Give Customer Service a Call & We'll Make it for You in Just 48 Hours!

TRACTOR-TO-TRAILER HOSES

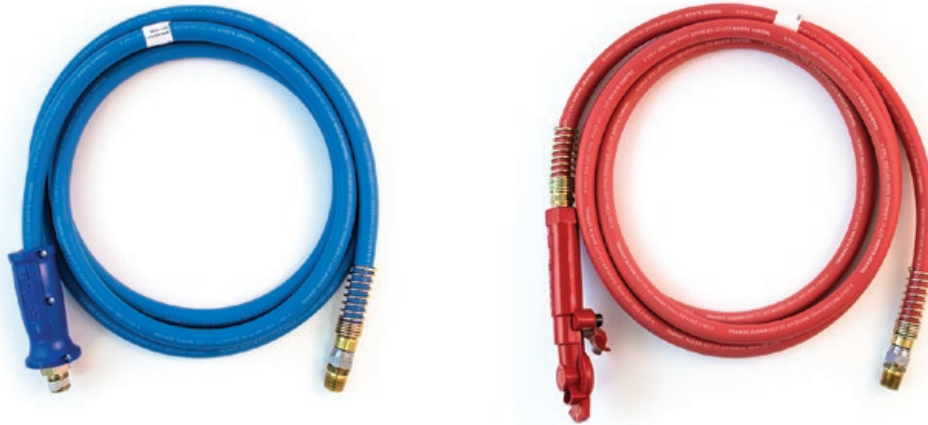

TRACTOR-TO-TRAILER ASSEMBLIES – BLUE HOSE

P/N	HOSE	LENGTH	HANDLE TYPE
B455144	3/8" Blue Hose	12 ft.	None
B455180	3/8" Blue Hose	15 ft.	None
B455240	3/8" Blue Hose	20 ft.	None
B455144B	3/8" Blue Hose	12 ft.	Blue Dura-Grip
B455180B	3/8" Blue Hose	15 ft.	Blue Dura-Grip
B455240B	3/8" Blue Hose	20 ft.	Blue Dura-Grip
B455144AB	3/8" Blue Hose	12 ft.	Blue Aluminum Grip
B455180AB	3/8" Blue Hose	15 ft.	Blue Aluminum Grip
B455240AB	3/8" Blue Hose	20 ft.	Blue Aluminum Grip
B455144BMAXX	3/8" Blue Hose	12 ft.	Blue Aluminum MAXXGrip Gladhand
B455180BMAXX	3/8" Blue Hose	15 ft.	Blue Aluminum MAXXGrip Gladhand
B455240BMAXX	3/8" Blue Hose	20 ft.	Blue Aluminum MAXXGrip Gladhand
B455144PBMAXX	3/8" Blue Hose	12 ft.	Blue Powder-Coated MAXXGrip Gladhand
B455180PBMAXX	3/8" Blue Hose	15 ft.	Blue Powder-Coated MAXXGrip Gladhand
B455240PBMAXX	3/8" Blue Hose	20 ft.	Blue Powder-Coated MAXXGrip Gladhand

TRACTOR-TO-TRAILER ASSEMBLIES – RED HOSE

P/N	HOSE	LENGTH	HANDLE TYPE
R455144	3/8" Red Hose	12 ft.	None
R455180	3/8" Red Hose	15 ft.	None
R455240	3/8" Red Hose	20 ft.	None
R455144R	3/8" Red Hose	12 ft.	Red Dura-Grip
R455180R	3/8" Red Hose	15 ft.	Red Dura-Grip
R455240R	3/8" Red Hose	20 ft.	Red Dura-Grip
R455144AR	3/8" Red Hose	12 ft.	Red Aluminum Grip
R455180AR	3/8" Red Hose	15 ft.	Red Aluminum Grip
R455240AR	3/8" Red Hose	20 ft.	Red Aluminum Grip
R455144RMAXX	3/8" Red Hose	12 ft.	Red Aluminum MAXXGrip Gladhand
R455180RMAXX	3/8" Red Hose	15 ft.	Red Aluminum MAXXGrip Gladhand
R455240RMAXX	3/8" Red Hose	20 ft.	Red Aluminum MAXXGrip Gladhand
R455144PRMAXX	3/8" Red Hose	12 ft.	Red Powder-Coated MAXXGrip Gladhand
R455180PRMAXX	3/8" Red Hose	15 ft.	Red Powder-Coated MAXXGrip Gladhand
R455240PRMAXX	3/8" Red Hose	20 ft.	Red Powder-Coated MAXXGrip Gladhand

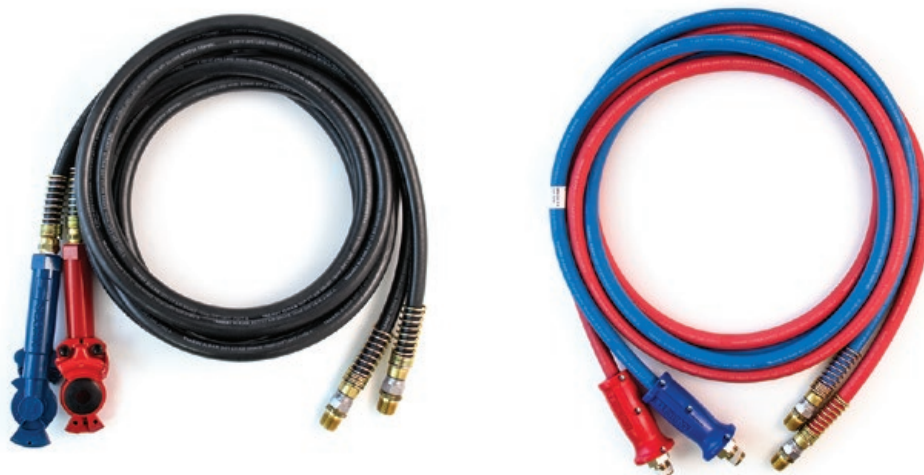

TRACTOR-TO-TRAILER HOSE SETS – BLACK HOSE

P/N	HOSE	LENGTH	HANDLE TYPE
455144SET	3/8" Black Hoses	12 ft.	None
455180SET	3/8" Black Hoses	15 ft.	None
455240SET	3/8" Black Hoses	20 ft.	None
455144DSET	3/8" Black Hoses	12 ft.	Dura-Grips
455180DSET	3/8" Black Hoses	15 ft.	Dura-Grips
455240DSET	3/8" Black Hoses	20 ft.	Dura-Grips
455144ASET	3/8" Black Hoses	12 ft.	Aluminum Grips
455180ASET	3/8" Black Hoses	15 ft.	Aluminum Grips
455240ASET	3/8" Black Hoses	20 ft.	Aluminum Grips
455144MAXXSET	3/8" Black Hoses	12 ft.	Aluminum MAXXGrip Gladhands
455180MAXXSET	3/8" Black Hoses	15 ft.	Aluminum MAXXGrip Gladhands
455240MAXXSET	3/8" Black Hoses	20 ft.	Aluminum MAXXGrip Gladhands
455144PMAXXSET	3/8" Black Hoses	12 ft.	Powder-Coated MAXXGrip Gladhands
455180PMAXXSET	3/8" Black Hoses	15 ft.	Powder-Coated MAXXGrip Gladhands
455240PMAXXSET	3/8" Black Hoses	20 ft.	Powder-Coated MAXXGrip Gladhands

TRACTOR-TO-TRAILER HOSE SETS – RED & BLUE HOSE

P/N	HOSE	LENGTH	HANDLE TYPE
BR455144SET	3/8" Red & Blue Hoses	12 ft.	None
BR455180SET	3/8" Red & Blue Hoses	15 ft.	None
BR455240SET	3/8" Red & Blue Hoses	20 ft.	None
BR455144DSET	3/8" Red & Blue Hoses	12 ft.	Dura-Grips
BR455180DSET	3/8" Red & Blue Hoses	15 ft.	Dura-Grips
BR455240DSET	3/8" Red & Blue Hoses	20 ft.	Dura-Grips
BR455144ASET	3/8" Red & Blue Hoses	12 ft.	Aluminum Grips
BR455180ASET	3/8" Red & Blue Hoses	15 ft.	Aluminum Grips
BR455240ASET	3/8" Red & Blue Hoses	20 ft.	Aluminum Grips
BR455144MAXXSET	3/8" Red & Blue Hoses	12 ft.	Aluminum MAXXGrip Gladhands
BR455180MAXXSET	3/8" Red & Blue Hoses	15 ft.	Aluminum MAXXGrip Gladhands
BR455240MAXXSET	3/8" Red & Blue Hoses	20 ft.	Aluminum MAXXGrip Gladhands
BR455144PMAXXSET	3/8" Red & Blue Hoses	12 ft.	Powder-Coated MAXXGrip Gladhands
BR455180PMAXXSET	3/8" Red & Blue Hoses	15 ft.	Powder-Coated MAXXGrip Gladhands
BR455240PMAXXSET	3/8" Red & Blue Hoses	20 ft.	Powder-Coated MAXXGrip Gladhands

TRACTOR-TO-TRAILER HOSES



WRAPPED TRACTOR-TO-TRAILER HOSE SETS – BLACK HOSE

P/N	HOSE	LENGTH	HANDLE TYPE
455144SETW	3/8" Black Hoses	12 ft.	None
455180SETW	3/8" Black Hoses	15 ft.	None
455240SETW	3/8" Black Hoses	20 ft.	None
455144DSETW	3/8" Black Hoses	12 ft.	Dura-Grips
455180DSETW	3/8" Black Hoses	15 ft.	Dura-Grips
455240DSETW	3/8" Black Hoses	20 ft.	Dura-Grips
455144ASETW	3/8" Black Hoses	12 ft.	Aluminum Grips
455180ASETW	3/8" Black Hoses	15 ft.	Aluminum Grips
455240ASETW	3/8" Black Hoses	20 ft.	Aluminum Grips
455144MAXXSETW	3/8" Black Hoses	12 ft.	Aluminum MAXXGrip Gladhands
455180MAXXSETW	3/8" Black Hoses	15 ft.	Aluminum MAXXGrip Gladhands
455240MAXXSETW	3/8" Black Hoses	20 ft.	Aluminum MAXXGrip Gladhands
455144PMAXXSETW	3/8" Black Hoses	12 ft.	Powder-Coated MAXXGrip Gladhands
455180PMAXXSETW	3/8" Black Hoses	15 ft.	Powder-Coated MAXXGrip Gladhands
455240PMAXXSETW	3/8" Black Hoses	20 ft.	Powder-Coated MAXXGrip Gladhands

WRAPPED TRACTOR-TO-TRAILER HOSE SETS – RED & BLUE HOSE

P/N	HOSE	LENGTH	HANDLE TYPE
BR455144SETW	3/8" Red & Blue Hoses	12 ft.	None
BR455180SETW	3/8" Red & Blue Hoses	15 ft.	None
BR455240SETW	3/8" Red & Blue Hoses	20 ft.	None
BR455144DSETW	3/8" Red & Blue Hoses	12 ft.	Dura-Grips
BR455180DSETW	3/8" Red & Blue Hoses	15 ft.	Dura-Grips
BR455240DSETW	3/8" Red & Blue Hoses	20 ft.	Dura-Grips
BR455144ASETW	3/8" Red & Blue Hoses	12 ft.	Aluminum Grips
BR455180ASETW	3/8" Red & Blue Hoses	15 ft.	Aluminum Grips
BR455240ASETW	3/8" Red & Blue Hoses	20 ft.	Aluminum Grips
BR455144MAXXSETW	3/8" Red & Blue Hoses	12 ft.	Aluminum MAXXGrip Gladhands
BR455180MAXXSETW	3/8" Red & Blue Hoses	15 ft.	Aluminum MAXXGrip Gladhands
BR455240MAXXSETW	3/8" Red & Blue Hoses	20 ft.	Aluminum MAXXGrip Gladhands
BR455144PMAXXSETW	3/8" Red & Blue Hoses	12 ft.	Powder-Coated MAXXGrip Gladhands
BR455180PMAXXSETW	3/8" Red & Blue Hoses	15 ft.	Powder-Coated MAXXGrip Gladhands
BR455240PMAXXSETW	3/8" Red & Blue Hoses	20 ft.	Powder-Coated MAXXGrip Gladhands



All Tramec Sloan
Hose Assemblies
are Made in the USA
at Each of Our Three
Manufacturing Plants.

Plus, They're Made with
Our Own Brass Fittings!

TRACTOR-TO-TRAILER HOSE

- 3/8" Black Hose
- 1/2"-14 NPTF Fixed Ends
- Spring Guards for Gladhand Use
- Also Available in Custom Lengths

P/N	LENGTH
460048	48"
460052	52"
460072	72"
460084	84"
460096	96"
460108	108"
460120	120"
460144	144"
460156	156"
460168	168"
460180	180"



COILED AIR ASSEMBLIES

LEADING THE INDUSTRY IN THE MANUFACTURE & DISTRIBUTION OF COILED AIR

Tramec Sloan Coiled Air Assemblies are **manufactured in the USA** at our facility in Holland, Michigan, using the highest quality components available. We certify our assemblies to meet **FMVSS 571.106 & 593.45** specifications and the individual components all meet the **SAE J844, SAE J476 & SAE J246** specifications.

Don't Take Chances; When You Buy Certified Tramec Sloan Coiled Air, You Buy American-Made Peace of Mind.

HOW WE MAKE IT:

1. Nylon tubing from large spools is wrapped onto mandrels to correct working lengths.
2. The coils are then pressurized before being baked. Pressurizing and baking both help the tubing retain its new coiled shape.
3. After coming out of the ovens and cooling, the coils are removed from the mandrels and are ready for some finishing touches.
4. Springs and our own brass fittings are fixed to the ends to create the finished assembly.

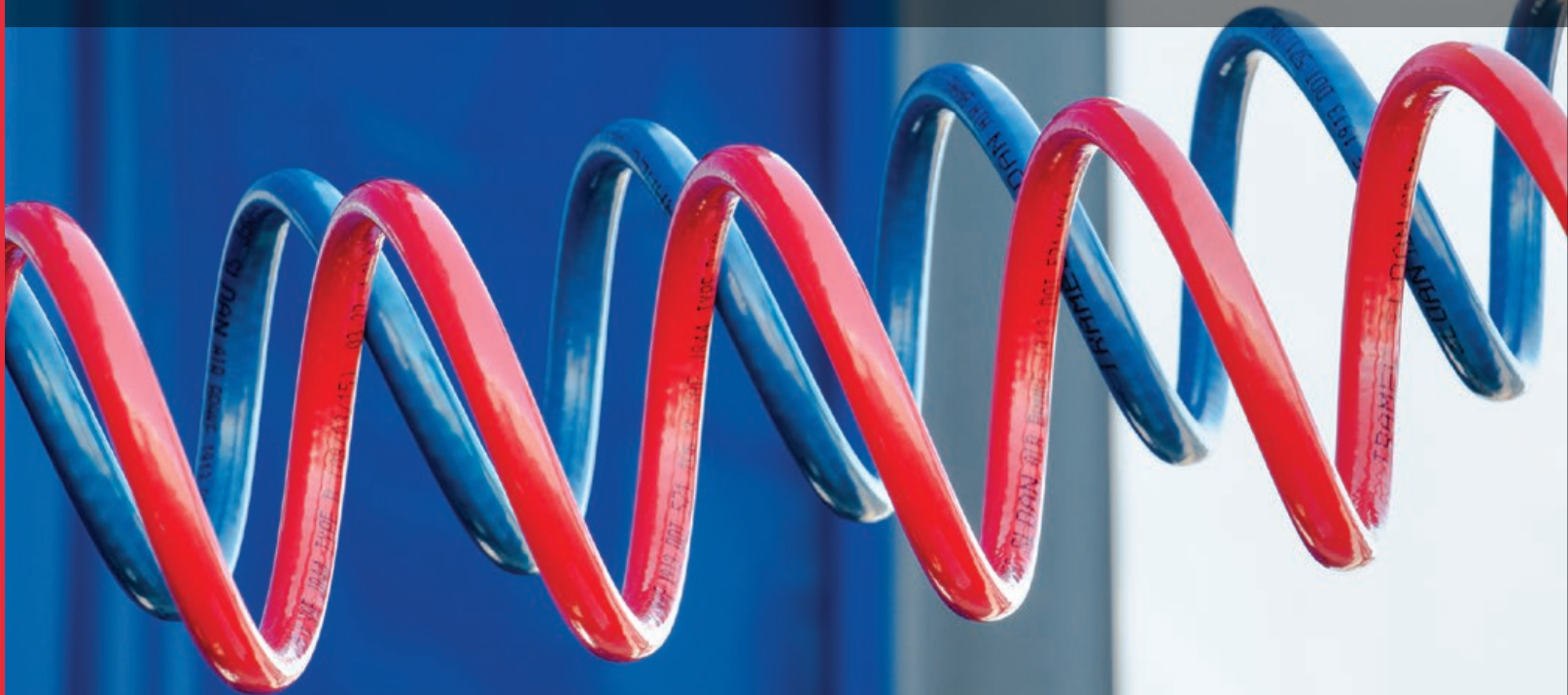
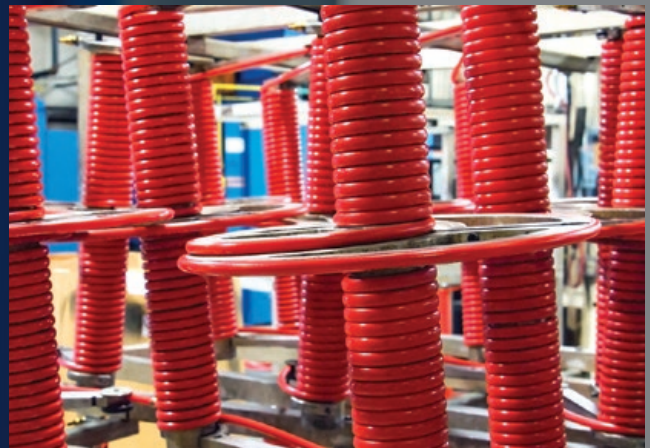



STANDARD COILED AIR ASSEMBLIES

This is Tramec Sloan's high-quality standard. It's available in many sizes and configurations that are all made to your specs in just 48 hours. Plus, it's **American made!** We create the coils and assemble them in Holland, MI using brass fittings made at our plant in Galion, OH.

- Made with 1/2" O.D. Nylon Tubing
- Working Pressure: 150 PSI
- Conforms to SAE J844
- Operating Temperature: -40°F to 200°F

P/N	DESCRIPTION	LENGTH	LEADS	FITTINGS
451035N	Coiled Air - SET	12 ft.	6"	1/2"
451035NB	Coiled Air Assembly - BLUE	12 ft.	6"	1/2"
451035NR	Coiled Air Assembly - RED	12 ft.	6"	1/2"
451036N	Coiled Air - SET	15 ft.	12"	1/2"
451036NB	Coiled Air Assembly - BLUE	15 ft.	12"	1/2"
451036NR	Coiled Air Assembly - RED	15 ft.	12"	1/2"
451039N	Coiled Air - SET	15 ft.	12" & 40"	1/2"
451039NB	Coiled Air Assembly - BLUE	15 ft.	12" & 40"	1/2"
451039NR	Coiled Air Assembly - RED	15 ft.	12" & 40"	1/2"
451056N	Coiled Air - SET	15 ft.	12"	3/8" & 1/2"
451056NB	Coiled Air Assembly - BLUE	15 ft.	12"	3/8" & 1/2"
451056NR	Coiled Air Assembly - RED	15 ft.	12"	3/8" & 1/2"
451061N	Coiled Air - SET	20 ft.	12"	1/2"
451061NB	Coiled Air Assembly - BLUE	20 ft.	12"	1/2"
451061NR	Coiled Air Assembly - RED	20 ft.	12"	1/2"
451243N	Coiled Air - SET	8 ft.	6"	1/2"
451243NB	Coiled Air Assembly - BLUE	8 ft.	6"	1/2"
451243NR	Coiled Air Assembly - RED	8 ft.	6"	1/2"
451093N	Coiled Air - SET	15 ft.	12" & 48"	1/2"
451093NB	Coiled Air Assembly - BLUE	15 ft.	12" & 48"	1/2"
451093NR	Coiled Air Assembly - RED	15 ft.	12" & 48"	1/2"
451092N	Coiled Air - SET	15 ft.	12" & 72"	1/2"
451092NB	Coiled Air Assembly - BLUE	15 ft.	12" & 72"	1/2"
451092NR	Coiled Air Assembly - RED	15 ft.	12" & 72"	1/2"

NOTE: Sets are available as 96 pieces on a skid

MAXXVALUE™ COILED AIR ASSEMBLIES High Quality at a Low Price!

MAXXValue coiled air is the industry's first low-cost coiled air that's **assembled in the USA** and is DOT tested and approved. Our new design allows us to cut costs *without* cutting corners.

- Made with 1/2" O.D. Nylon Tubing
- Meets FMVSS 571.106 and 593.45 specs
- Working Pressure: 150 PSI
- Operating Temperature: -40°F to 200°F



P/N	DESCRIPTION	LENGTH	LEADS	FITTINGS
451035MV	MAXXValue Coiled Air - SET	12'	12"	1/2"
451035MVB	MAXXValue Coiled Air Assembly - BLUE	12'	12"	1/2"
451035MVR	MAXXValue Coiled Air Assembly - RED	12'	12"	1/2"
451036MV	MAXXValue Coiled Air - SET	15'	12"	1/2"
451036MVB	MAXXValue Coiled Air Assembly - BLUE	15'	12"	1/2"
451036MVR	MAXXValue Coiled Air Assembly - RED	15'	12"	1/2"
451039MV	MAXXValue Coiled Air - SET	15'	12" & 40"	1/2"
451039MVB	MAXXValue Coiled Air Assembly - BLUE	15'	12" & 40"	1/2"
451039MVR	MAXXValue Coiled Air Assembly - RED	15'	12" & 40"	1/2"

COILED AIR ASSEMBLIES WITH DURA-GRIP®

Tramec Sloan's high-quality standard coiled air with Dura-Grip handles. Dura-Grips provide an ergonomic hold that resists cracking in sub-zero temperatures. **American made!**

- Made with 1/2" O.D. Nylon Tubing
- Conforms to SAE J844
- Working Pressure: 150 PSI
- Operating Temperature: -40°F to 200°F



P/N	DESCRIPTION	LENGTH	LEADS	FITTINGS
451089N	Coiled Air with Dura-Grip Handles - SET	15 ft.	12"	1/2"
451089NB	Coiled Air Assembly with Dura-Grip Handle - BLUE	15 ft.	12"	1/2"
451089NR	Coiled Air Assembly with Dura-Grip Handle - RED	15 ft.	12"	1/2"
451090N	Coiled Air with Dura-Grip Handle - SET	15 ft.	12" & 40"	1/2"
451090NB	Coiled Air Assembly with Dura-Grip Handle - BLUE	15 ft.	12" & 40"	1/2"
451090NR	Coiled Air Assembly with Dura-Grip Handle - RED	15 ft.	12" & 40"	1/2"

COILED AIR ASSEMBLIES WITH BRASS HANDLE

Tramec Sloan's high-quality standard coiled air with brass handles for built-in grip. **American made!**

- Made with 1/2" O.D. Nylon Tubing
- Conforms to SAE J844
- Working Pressure: 150 PSI
- Operating Temperature: -40°F to 200°F



P/N	DESCRIPTION	LENGTH	LEADS	FITTINGS
451040N	Coiled Air with Brass Handle - SET	12 ft.	6"	1/2"
451040NB	Coiled Air Assembly with Brass Handle - BLUE	12 ft.	6"	1/2"
451040NR	Coiled Air Assembly with Brass Handle - RED	12 ft.	6"	1/2"
451041N	Coiled Air with Brass Handle - SET	15 ft.	12"	1/2"
451041NB	Coiled Air Assembly with Brass Handle - BLUE	15 ft.	12"	1/2"
451041NR	Coiled Air Assembly with Brass Handle - RED	15 ft.	12"	1/2"
451042N	Coiled Air with Brass Handle - SET	15 ft.	12" & 40"	1/2"
451042NB	Coiled Air Assembly with Brass Handle - BLUE	15 ft.	12" & 40"	1/2"
451042NR	Coiled Air Assembly with Brass Handle - RED	15 ft.	12" & 40"	1/2"
451091N	Coiled Air with Brass Handle - SET	15 ft.	12" & 48"	1/2"
451091NB	Coiled Air Assembly with Brass Handle - BLUE	15 ft.	12" & 48"	1/2"
451091NR	Coiled Air Assembly with Brass Handle - RED	15 ft.	12" & 48"	1/2"

COILED AIR ASSEMBLIES WITH SWIVEL FITTINGS

These are our high-quality standard coiled air assemblies with the added benefits of live swivel fittings. **American made!**

- Made with 1/2" O.D. Nylon Tubing
- Conforms to SAE J844
- Working Pressure: 150 PSI
- Operating Temperature: -40°F to 200°F

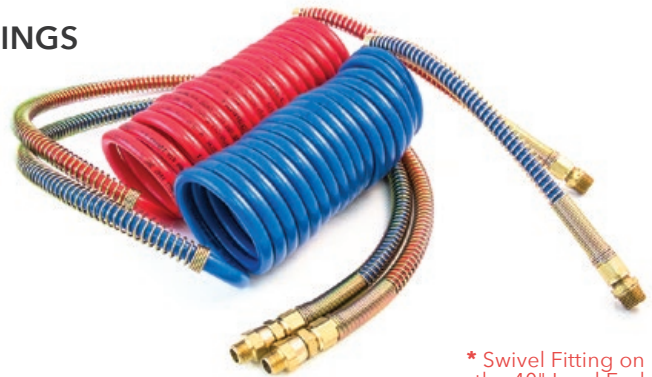

* Swivel Fitting on the 40" Lead End

P/N	DESCRIPTION	LENGTH	LEADS	FITTINGS
451064N	Coiled Air - SET	8 ft.	6"	3/8" Swivels
451064NB	Coiled Air Assembly - BLUE	8 ft.	6"	3/8" Swivels
451064NR	Coiled Air Assembly - RED	8 ft.	6"	3/8" Swivels
451035NS	Coiled Air with Swivel - SET	12'	6"	1/2" Fixed & Swivel
451035NBS	Coiled Air Assembly with Swivel - BLUE	12'	6"	1/2" Fixed & Swivel
451035NRS	Coiled Air Assembly with Swivel - RED	12'	6"	1/2" Fixed & Swivel
451036NS	Coiled Air with Swivel - SET	15'	12"	1/2" Fixed & Swivel
451036NBS	Coiled Air Assembly with Swivel - BLUE	15'	12"	1/2" Fixed & Swivel
451036NRS	Coiled Air Assembly with Swivel - RED	15'	12"	1/2" Fixed & Swivel
451039NS	Coiled Air with Swivel - SET	15'	12" & 40"	1/2" Fixed & Swivel*
451039NBS	Coiled Air Assembly with Swivel - BLUE	15'	12" & 40"	1/2" Fixed & Swivel*
451039NRS	Coiled Air Assembly with Swivel - RED	15'	12" & 40"	1/2" Fixed & Swivel*

MAXXDUTY™ COILED AIR ASSEMBLIES

- Working Pressure: 150 PSI
- Operating Temperature: -70°F to 220°F
- Sets are Available as 96 Pieces on a Skid

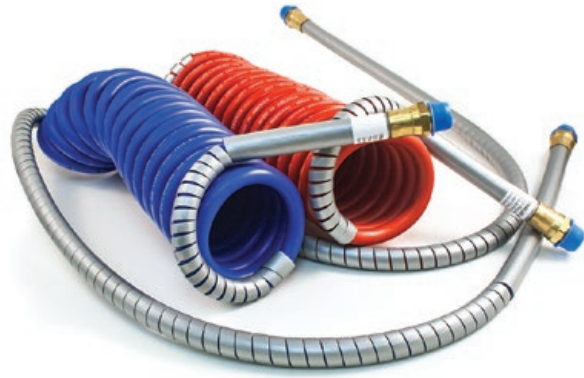

P/N	DESCRIPTION	LENGTH	LEADS	FITTINGS
451035	MAXXDuty Coiled Air - SET	12'	6"	1/2"
451035B	MAXXDuty Coiled Air - BLUE	12'	6"	1/2"
451035R	MAXXDuty Coiled Air - RED	12'	6"	1/2"
451036	MAXXDuty Coiled Air - SET	15'	10"	1/2"
451036B	MAXXDuty Coiled Air - BLUE	15'	10"	1/2"
451036R	MAXXDuty Coiled Air - RED	15'	10"	1/2"
451039	MAXXDuty Coiled Air - SET	15'	10" & 40"	1/2"
451039B	MAXXDuty Coiled Air - BLUE	15'	10" & 40"	1/2"
451039R	MAXXDuty Coiled Air - RED	15'	10" & 40"	1/2"

COILED AIR DISPLAY BOX

- Eye-Catching New Design!
- Sturdy Display Holds Up to 36 Coiled Air Sets
- Comes Fully Stocked with Sets of Tramec Sloan's American Made Coiled Air Assemblies
- Box is 20" x 20" x 40" and Includes a 16" Tall Header Card
- Just Like Our Coiled Air, the Display is Made in the USA!



P/N	DESCRIPTION	QTY
451066	Display Box Only - No Stock	None
451035NP	Display Box with 12' Standard Coiled Air Sets (451035N)	36 Sets
451036NP	Display Box with 15' Standard Coiled Air Sets (451036N)	24 Sets
451039NP	Display Box with 15' Standard Coiled Air Sets with 40" Leads (451039N)	18 Sets
451035MVP	Display Box with 12' MAXXValue Coiled Air Sets (451035MV)	36 Sets
451036MVP	Display Box with 15' MAXXValue Coiled Air Sets (451036MV)	24 Sets
451039MVP	Display Box with 15' MAXXValue Coiled Air Sets with 40" Leads (451039MV)	18 Sets

FIFTH WHEEL SLIDER COILS

- 1/4" Black Nylon Tubing
- Fittings: 1/4"-14 NPTF
- **American Made!**



P/N	DESCRIPTION	LENGTH	SPRINGS
451055	Fifth Wheel Slider Coil	54"	✓
VCA029	Fifth Wheel Slider Coil	54"	-
451301	Fifth Wheel Slider Coil	72"	✓
451302	Fifth Wheel Slider Coil	72"	-

CAB BLOWER KIT

Keep Your Cab Clean!

KIT INCLUDES:

- 72" Nylon Coil (1/4" O.D.)
- Rubber-Tipped Blow Gun with Hang-Up Hook for Simple Storage
- OSHA Safety Tip
- 1/4" DOT Brass Tee Fitting
- 1/4" DOT Brass Male Connector
- Two Spring Guards



P/N	DESCRIPTION
451244	Cab Blower Kit

TIRE INFLATOR/CAB BLOWER

Complete Assembly Includes:

- 1/4" NPT Universal Gladhand (P/N 441145)
- 50' Heavy Duty Air Line with 1/4" NPT
- 1/4" NPT Tire Inflator and 1/4" Blow Gun

P/N	DESCRIPTION
451102	Complete Tire Inflator Assembly
451103	3/8" Tubing, 50' with 1/4" NPT
451104	Tire Inflator, 1/4" NPT
451105	Blow Gun, 1/4" NPT



BULK NYLON AIR BRAKE TUBING

FEATURES & BENEFITS

- UV and OZONE Resistant
- Resistant to Gasoline, Diesel Fuel and other Chemicals
- Great Resistance Against Aging from Heat and Light
- Great Flexibility
- 150 PSI Working Pressure
- Manufactured Out of Heat & Light Stabilized Nylon
- Tubing from 1/8" to 1/4" O.D. are of Single-Wall Construction Type A
- Tubing from 3/8" to 3/4" O.D. have a Double-Wall Construction with a Nylon Core, Synthetic Fiber Braid & Nylon Cover Type B

APPLICATIONS

- Truck Air Brake Systems
- Trailer Air Brake Systems
- Auxiliary Air Systems
- Formed Tubes
- Formed and Straight Air Brake Harness Assemblies

TEMPERATURE RANGE

Tramec Sloan Air Brake Tubing is designed for a wide operating temperature range: -40°F to 200°F (-40°C to 93°C)

STANDARD COMPLIANCE

All Sizes Meet or Exceed SAE J844 and DOT FMVSS 571.106

COLORS AVAILABLE

Tubing comes standard in **BLACK, BLUE, RED, GREEN, ORANGE,** and **YELLOW.** Special colors are also available upon request. Contact customer service for more information.

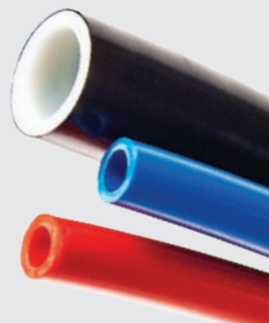

1/8" NYLON TUBING

P/N	LENGTH	O.D.	COLOR
451029-50	50 ft.	1/8"	Black
451029	100 ft.	1/8"	Black
451029-250	250 ft.	1/8"	Black
451029-1000	1000 ft.	1/8"	Black

5/32" NYLON TUBING

P/N	LENGTH	O.D.	COLOR
451067-50	50 ft.	5/32"	Black
451067	100 ft.	5/32"	Black
451067-1000	1000 ft.	5/32"	Black

3/16" NYLON TUBING

P/N	LENGTH	O.D.	COLOR
451068-50	50 ft.	3/16"	Black
451068	100 ft.	3/16"	Black
451068-250	250 ft.	3/16"	Black
451068-1000	1000 ft.	3/16"	Black

1/4" NYLON TUBING

P/N	LENGTH	O.D.	COLOR
451030	100 ft.	1/4"	Black
451030B	100 ft.	1/4"	Blue
451030G	100 ft.	1/4"	Green
451030NG	100 ft.	1/4"	Orange
451030P	100 ft.	1/4"	Purple
451030R	100 ft.	1/4"	Red
451030Y	100 ft.	1/4"	Yellow
451030-250	250 ft.	1/4"	Black
451030-500	500 ft.	1/4"	Black
451030B-500	500 ft.	1/4"	Blue
451030G-500	500 ft.	1/4"	Green
451030NG-500	500 ft.	1/4"	Orange
451030R-500	500 ft.	1/4"	Red
451030-1000	1000 ft.	1/4"	Black
451030B-1000	1000 ft.	1/4"	Blue
451030G-1000	1000 ft.	1/4"	Green
451030NG-1000	1000 ft.	1/4"	Orange
451030P-1000	1000 ft.	1/4"	Purple
451030R-1000	1000 ft.	1/4"	Red
451030S-1000	1000 ft.	1/4"	Silver
451030WH-1000	1000 ft.	1/4"	White
451030Y-1000	1000 ft.	1/4"	Yellow

5/16" NYLON TUBING

P/N	LENGTH	O.D.	COLOR
451054	100 ft.	5/16"	Black
451054-500	500 ft.	5/16"	Black

3/8" NYLON TUBING

P/N	LENGTH	O.D.	COLOR
451031-50	50 ft.	3/8"	Black
451031	100 ft.	3/8"	Black
451031B	100 ft.	3/8"	Blue
451031G	100 ft.	3/8"	Green
451031NG	100 ft.	3/8"	Orange
451031R	100 ft.	3/8"	Red
451031Y	100 ft.	3/8"	Yellow
451031-500	500 ft.	3/8"	Black
451031B-500	500 ft.	3/8"	Blue
451031G-500	500 ft.	3/8"	Green
451031NG-500	500 ft.	3/8"	Orange
451031R-500	500 ft.	3/8"	Red
451031Y-500	500 ft.	3/8"	Yellow

1/2" NYLON TUBING

P/N	LENGTH	O.D.	COLOR
451032-50	50 ft.	1/2"	Black
451032	100 ft.	1/2"	Black
451032B	100 ft.	1/2"	Blue
451032G	100 ft.	1/2"	Green
451032NG	100 ft.	1/2"	Orange
451032R	100 ft.	1/2"	Red
451032Y	100 ft.	1/2"	Yellow
451032-500	500 ft.	1/2"	Black
451032B-500	500 ft.	1/2"	Blue
451032G-500	500 ft.	1/2"	Green
451032NG-500	500 ft.	1/2"	Orange
451032R-500	500 ft.	1/2"	Red
451032Y-500	500 ft.	1/2"	Yellow

5/8" NYLON TUBING

P/N	LENGTH	O.D.	COLOR
451033	50 ft.	5/8"	Black
451033B	50 ft.	5/8"	Blue
451033G	50 ft.	5/8"	Green
451033NG	50 ft.	5/8"	Orange
451033R	50 ft.	5/8"	Red
451033Y	50 ft.	5/8"	Yellow
451033-100	100 ft.	5/8"	Black
451033-250	250 ft.	5/8"	Black
451033B-250	250 ft.	5/8"	Blue
451033G-250	250 ft.	5/8"	Green
451033NG-250	250 ft.	5/8"	Orange
451033R-250	250 ft.	5/8"	Red
451033Y-250	250 ft.	5/8"	Yellow

3/4" NYLON TUBING

P/N	LENGTH	O.D.	COLOR
451034	50 ft.	3/4"	Black
451034G-50	50 ft.	3/4"	Green
451034NG-50	50 ft.	3/4"	Orange
451034R-50	50 ft.	3/4"	Red
451034-250	250 ft.	3/4"	Black
451034B-250	250 ft.	3/4"	Blue
451034G-250	250 ft.	3/4"	Green
451034NG-250	250 ft.	3/4"	Orange
451034R-250	250 ft.	3/4"	Red

TUBE CUTTER

- For Nylon Air Brake Tubing
- Makes Creating Clean Cuts Simple



P/N	DESCRIPTION
451100	Tube Cutting Tool

TS TECH TIP:

Always cut tubing squarely and with a clean edge to ensure a tight seal that's free from leaks. Using a tube cutter will provide the best edge.



BULK RUBBER HOSE

BULK RUBBER AIR BRAKE HOSE

- **American Made!**
- **Red & Blue** Hose is Great for Differentiating Hose Lines Under the Trailer
- Meets DOT 106 & SAE J1402
- Max. Operating Pressure: 225 PSI
- Operating Temperature: -40°F to 212°F
- Resistant to Gasoline, Diesel Fuel, Oil, and Commonly Used Road & Cleaning Chemicals



P/N	DESCRIPTION	LENGTH	I.D.	O.D.	COLOR
14250	Bulk Rubber Air Brake Hose	250 ft.	1/4"	5/8"	Black
451027	Bulk Rubber Air Brake Hose	50 ft.	3/8"	3/4"	Black
451062	Bulk Rubber Air Brake Hose	100 ft.	3/8"	3/4"	Black
451028	Bulk Rubber Air Brake Hose	250 ft.	3/8"	3/4"	Black
3160001	Bulk Rubber Air Brake Hose	500 ft.	3/8"	3/4"	Black
451045	Bulk Rubber Air Brake Hose	50 ft.	1/2"	7/8"	Black
451063	Bulk Rubber Air Brake Hose	100 ft.	1/2"	7/8"	Black
451044	Bulk Rubber Air Brake Hose	250 ft.	1/2"	7/8"	Black
3180001	Bulk Rubber Air Brake Hose	500 ft.	1/2"	7/8"	Black
31102B	Bulk Rubber Air Brake Hose	50 ft.	3/8"	3/4"	Blue
31102R	Bulk Rubber Air Brake Hose	50 ft.	3/8"	3/4"	Red
31002B	Bulk Rubber Air Brake Hose	250 ft.	3/8"	3/4"	Blue
31002R	Bulk Rubber Air Brake Hose	250 ft.	3/8"	3/4"	Red
3160001B	Bulk Rubber Air Brake Hose	500 ft.	3/8"	3/4"	Blue
3160001R	Bulk Rubber Air Brake Hose	500 ft.	3/8"	3/4"	Red

BULK ARCTIC HOSE

- Intended for Harsh, Low-Temperature Environments. Rated for -65°F
- Bulk Air Brake Hose is Certified to Meet All Pertinent SAE J1402 and DOT Requirements Including FMVSS 571.106 Specs



P/N	DESCRIPTION	LENGTH	I.D.
451027A	Bulk Arctic Air Brake Hose	50 ft.	3/8"
451028A	Bulk Arctic Air Brake Hose	250 ft.	3/8"

AIR BRAKE HOSE ASSEMBLIES

HIGH-QUALITY, AMERICAN MADE RUBBER AIR BRAKE HOSES

Tramec Sloan rubber air brake hoses are **made in the USA** from American-made rubber hose and brass fittings manufactured by American workers at our plant in Galion, OH which are then assembled at all 3 of our US-based factories.

YOUR SAFETY IS OUR FIRST PRIORITY

At Tramec Sloan, we use the highest quality materials and manufacturing methods, including state of the art, computer driven crimping machines that measure and ensure every hose is assembled correctly every time. Periodic **quality checks** are conducted; including tensile, burst, and ID flow tests.



USED BY MOST MAJOR TRAILER MANUFACTURERS!

There's a reason Tramec Sloan is trusted by the OEMs. All of Tramec Sloan's air brake hose assemblies are made in the U.S. and meet the following criteria:

- Minimum Burst Pressure of 900 PSI
- Conforms to SAE J1402 & DOT-106 Specs
- Maximum Operating Pressure of 225 PSI
- Operating Temperature of -40°F to +212°F
- Resistant to Gasoline, Diesel Fuel, Oil, & Commonly Used Road & Cleaning Chemicals

Looking for a custom configuration? Our hoses are available with springs, presealed pipe threads, custom lengths, red & blue hose, and more! Give us a call and we'll create your custom hose in just 48 hours!



TRAMEC SLOAN USES
OVER 20 MILLION FEET
OF HOSE EACH YEAR
(AND GROWING!)

PERMANENT LIVE SWIVEL HOSES

FEATURES:

- Made with All-Brass Swivel Fittings
- Permanent Live Swivel Fittings Retain their Ability to Swivel After Installation

THESE HOSES ARE AVAILABLE WITH:

- Vibra-Seal Pipe Thread Sealant for Leak-Free Connections
- Spring Guards: Ideal when there is Potential for Hose to Bend Too Tightly, Causing Kinks
- 3/8" Red & Blue Hose for Easy Line Identification
- 3/8" Arctic Hose for Low-Temperature Applications (Temps as Low as -65°F)
- Custom Lengths



1/2" HOSE

3/8"-18 NPTF SWIVELS

P/N	LENGTH
454008	8"
454012	12"
454014	14"
454016	16"
454018	18"
454020	20"
454022	22"
454024	24"
454026	26"
454027	27"
454028	28"
454030	30"
454032	32"
454034	34"
454036	36"
454038	38"
454040	40"
454042	42"
454044	44"
454046	46"
454048	48"
454050	50"
454052	52"
454056	56"
454060	60"
454066	66"
454072	72"
454084	84"

3/8" HOSE

3/8"-18 NPTF SWIVELS

P/N	LENGTH
455008	8"
455012	12"
455014	14"
455016	16"
455018	18"
455020	20"
455022	22"
455024	24"
455026	26"
455028	28"
455030	30"
455032	32"
455034	34"
455036	36"
455038	38"
455040	40"
455042	42"
455044	44"
455046	46"
455048	48"
455050	50"
455052	52"
455056	56"
455060	60"
455066	66"
455072	72"
455084	84"

3/8" HOSE

1/4"-18 NPTF SWIVELS

P/N	LENGTH
456008	8"
456012	12"
456014	14"
456016	16"
456018	18"
456020	20"
456022	22"
456024	24"
456026	26"
456028	28"
456030	30"
456032	32"
456034	34"
456036	36"
456038	38"
456040	40"
456042	42"
456044	44"
456046	46"
456048	48"
456050	50"
456052	52"
456056	56"
456060	60"
456066	66"
456072	72"
456084	84"

AIR BRAKE HOSE ASSEMBLIES

MAXXDUTY™ HOSE ASSEMBLIES

FEATURES:

- **Blue Plating is Specifically Engineered to Fight Corrosion!** It was Originally Developed for Naval Applications Where Parts are Constantly Exposed to Salt Spray
- Retains Swiveling Ability Even after Long-Term Exposure to Corrosive Chemicals
- Retains Rust-Free Finish Longer than Industry Standard Hose Assemblies

THESE HOSES ARE AVAILABLE WITH:

- Vibra-Seal Pipe Thread Sealant for Leak-Free Connections
- Spring Guards: Ideal when there is Potential for Hose to Bend Too Tightly, Causing Kinks
- 3/8" Red & Blue Hose for Easy Line Identification
- 3/8" Arctic Hose for Low-Temperature Applications (Temps as Low as -65°F)
- Custom Lengths

3/8" HOSE

1/4"-18 NPTF, 1 FIXED 1 SWIVEL

P/N	LENGTH
453108MAX	8"
453112MAX	12"
453114MAX	14"
453116MAX	16"
453118MAX	18"
453120MAX	20"
453122MAX	22"
453124MAX	24"
453126MAX	26"
453128MAX	28"
453130MAX	30"
453132MAX	32"
453134MAX	34"
453136MAX	36"
453138MAX	38"
453140MAX	40"
453142MAX	42"
453144MAX	44"
453146MAX	46"
453148MAX	48"
453150MAX	50"
453152MAX	52"
453154MAX	54"
453156MAX	56"
453160MAX	60"
453166MAX	66"
453172MAX	72"
453184MAX	84"

3/8" HOSE

3/8"-18 NPTF, 1 FIXED 1 SWIVEL

P/N	LENGTH
453208MAX	8"
453212MAX	12"
453214MAX	14"
453216MAX	16"
453218MAX	18"
453220MAX	20"
453222MAX	22"
453224MAX	24"
453226MAX	26"
453228MAX	28"
453230MAX	30"
453232MAX	32"
453234MAX	34"
453236MAX	36"
453238MAX	38"
453240MAX	40"
453242MAX	42"
453244MAX	44"
453246MAX	46"
453248MAX	48"
453250MAX	50"
453252MAX	52"
453254MAX	54"
453256MAX	56"
453260MAX	60"
453266MAX	66"
453272MAX	72"
453284MAX	84"

3/8" HOSE

3/8"-18 NPTF, 2 SWIVELS

P/N	LENGTH
453308MAX	8"
453312MAX	12"
453314MAX	14"
453316MAX	16"
453318MAX	18"
453320MAX	20"
453322MAX	22"
453324MAX	24"
453326MAX	26"
453328MAX	28"
453330MAX	30"
453332MAX	32"
453334MAX	34"
453336MAX	36"
453338MAX	38"
453340MAX	40"
453342MAX	42"
453344MAX	44"
453346MAX	46"
453348MAX	48"
453350MAX	50"
453352MAX	52"
453356MAX	56"
453360MAX	60"
453366MAX	66"
453372MAX	72"
453384MAX	84"

AIR BRAKE HOSE ASSEMBLIES



1/2" HOSE 3/8"-18 NPTF, 1 FIXED 1 SWIVEL

P/N	LENGTH
452108MAX	8"
452112MAX	12"
452114MAX	14"
452116MAX	16"
452118MAX	18"
452120MAX	20"
452122MAX	22"
452124MAX	24"
452126MAX	26"
452128MAX	28"
452130MAX	30"
452132MAX	32"
452134MAX	34"
452136MAX	36"
452138MAX	38"
452140MAX	40"
452142MAX	42"
452144MAX	44"
452146MAX	46"
452148MAX	48"
452150MAX	50"
452152MAX	52"
452154MAX	54"
452156MAX	56"
452160MAX	60"
452166MAX	66"
452172MAX	72"
452184MAX	84"

1/2" HOSE 3/8"-18 NPTF, 2 SWIVELS

P/N	LENGTH
452208MAX	8"
452212MAX	12"
452214MAX	14"
452216MAX	16"
452218MAX	18"
452220MAX	20"
452222MAX	22"
452224MAX	24"
452226MAX	26"
452228MAX	28"
452230MAX	30"
452232MAX	32"
452234MAX	34"
452236MAX	36"
452238MAX	38"
452240MAX	40"
452242MAX	42"
452244MAX	44"
452246MAX	46"
452248MAX	48"
452250MAX	50"
452252MAX	52"
452256MAX	56"
452260MAX	60"
452266MAX	66"
452272MAX	72"
452284MAX	84"

1/2" HOSE 1/2"-14 NPTF FIXED AND 3/8"-18 NPTF SWIVEL

P/N	LENGTH
452308MAX	8"
452312MAX	12"
452314MAX	14"
452316MAX	16"
452318MAX	18"
452320MAX	20"
452322MAX	22"
452324MAX	24"
452326MAX	26"
452328MAX	28"
452330MAX	30"
452332MAX	32"
452334MAX	34"
452336MAX	36"
452338MAX	38"
452340MAX	40"
452342MAX	42"
452344MAX	44"
452346MAX	46"
452348MAX	48"
452350MAX	50"
452352MAX	52"
452356MAX	56"
452360MAX	60"
452366MAX	66"
452372MAX	72"
452384MAX	84"

ADAPTER STYLE HOSE ASSEMBLIES

FEATURES:

- Traditional adapter-swivel is comprised of a brass adapter and steel nut, which creates a metal-to-metal seal when installed.
- Adapters can be changed to offer various thread sizes, making it an ideal aftermarket hose because of this versatility.
- Zinc-nickle plating on the nut provides increased corrosion resistance

THESE HOSES ARE AVAILABLE WITH:

- Vibra-Seal Pipe Thread Sealant for Leak-Free Connections
- Spring Guards: Ideal when there is Potential for Hose to Bend Too Tightly, Causing Kinks
- 3/8" Red & Blue Hose for Easy Line Identification
- 3/8" Arctic Hose for Low-Temperature Applications (Temps as Low as -65°F)

3/8" HOSE

1/4"-18 NPTF, 1 FIXED 1 SWIVEL

P/N	LENGTH
453108	8"
453112	12"
453114	14"
453116	16"
453118	18"
453120	20"
453122	22"
453124	24"
453126	26"
453128	28"
453130	30"
453132	32"
453134	34"
453136	36"
453138	38"
453140	40"
453142	42"
453144	44"
453146	46"
453148	48"
453150	50"
453152	52"
453154	54"
453156	56"
453160	60"
453166	66"
453172	72"
453184	84"

3/8" HOSE

1/4"-18 NPTF, 2 SWIVELS

P/N	LENGTH
453408	8"
453412	12"
453414	14"
453416	16"
453418	18"
453420	20"
453422	22"
453424	24"
453426	26"
453428	28"
453430	30"
453432	32"
453434	34"
453436	36"
453438	38"
453440	40"
453442	42"
453444	44"
453446	46"
453448	48"
453450	50"
453452	52"
453454	54"
453456	56"
453460	60"
453466	66"
453472	72"
453484	84"

3/8" HOSE

3/8"-18 NPTF, 1 FIXED 1 SWIVEL

P/N	LENGTH
453208	8"
453212	12"
453214	14"
453216	16"
453218	18"
453220	20"
453222	22"
453224	24"
453226	26"
453228	28"
453230	30"
453232	32"
453234	34"
453236	36"
453238	38"
453240	40"
453242	42"
453244	44"
453246	46"
453248	48"
453250	50"
453252	52"
453254	54"
453256	56"
453260	60"
453266	66"
453272	72"
453284	84"

AIR BRAKE HOSE ASSEMBLIES



3/8" HOSE

3/8"-18 NPTF, 2 SWIVELS

P/N	LENGTH
453308	8"
453312	12"
453314	14"
453316	16"
453318	18"
453320	20"
453322	22"
453324	24"
453326	26"
453328	28"
453330	30"
453332	32"
453334	34"
453336	36"
453338	38"
453340	40"
453342	42"
453344	44"
453346	46"
453348	48"
453350	50"
453352	52"
453354	54"
453356	56"
453360	60"
453366	66"
453372	72"
453384	84"

1/2" HOSE

3/8"-18 NPTF, 1 FIXED 1 SWIVEL

P/N	LENGTH
452108	8"
452112	12"
452114	14"
452116	16"
452118	18"
452120	20"
452122	22"
452124	24"
452126	26"
452128	28"
452130	30"
452132	32"
452134	34"
452136	36"
452138	38"
452140	40"
452142	42"
452144	44"
452146	46"
452148	48"
452150	50"
452152	52"
452154	54"
452156	56"
452160	60"
452166	66"
452172	72"
452184	84"

1/2" HOSE

3/8"-18 NPTF, 2 SWIVELS

P/N	LENGTH
452208	8"
452212	12"
452214	14"
452216	16"
452218	18"
452220	20"
452222	22"
452224	24"
452226	26"
452228	28"
452230	30"
452232	32"
452234	34"
452236	36"
452238	38"
452240	40"
452242	42"
452244	44"
452246	46"
452250	48"
452252	50"
452252	52"
452254	54"
452256	56"
452260	60"
452266	66"
452272	72"
452284	84"

COMPOSITE LIVE SWIVEL HOSE ASSEMBLIES

FEATURES:

- Heavy-Duty Composite Shells with Live Swivel Fittings
- A Tramec Sloan Original Design Based on the Iconic 31402 Quick-Fix® (Page 122)
- Brass Barb for Gladhand Use
- Spring Guards: Ideal when there is Potential for Hose to Bend Too Tightly, Causing Kinks
- 3/8" Red & Blue Hose for Easy Line I.D.
- 3/8" Arctic Hose for Low-Temperature Applications (Temps as Low as -65°F)

THESE HOSES ARE AVAILABLE WITH:

- Vibra-Seal Pipe Thread Sealant for Leak-Free Connections
- Custom Lengths

3/8" HOSE

3/8" NPTF, 2 SWIVELS

P/N	LENGTH
31002-012	12"
31002-014	14"
31002-016	16"
31002-018	18"
31002-020	20"
31002-022	22"
31002-024	24"
31002-026	26"
31002-028	28"
31002-030	30"
31002-032	32"
31002-034	34"
31002-036	36"
31002-038	38"
31002-040	40"
31002-042	42"
31002-044	44"
31002-046	46"
31002-048	48"
31002-050	50"
31002-052	52"
31002-054	54"
31002-056	56"
31002-058	58"
31002-060	60"
31002-062	62"
31002-064	64"
31002-066	66"
31002-068	68"
31002-070	70"
31002-072	72"
31002-084	84"

3/8" HOSE

1/2" NPTF, 2 SWIVELS

P/N	LENGTH
31003-012	12"
31003-014	14"
31003-016	16"
31003-018	18"
31003-020	20"
31003-022	22"
31003-024	24"
31003-026	26"
31003-028	28"
31003-030	30"
31003-032	32"
31003-034	34"
31003-036	36"
31003-038	38"
31003-040	40"
31003-042	42"
31003-044	44"
31003-046	46"
31003-048	48"
31003-050	50"
31003-052	52"
31003-054	54"
31003-056	56"
31003-058	58"
31003-060	60"
31003-062	62"
31003-064	64"
31003-066	66"
31003-068	68"
31003-070	70"
31003-072	72"
31003-084	84"

3/8" HOSE

3/8" & 1/2" NPTF SWIVELS

P/N	LENGTH
31009-012	12"
31009-014	14"
31009-016	16"
31009-018	18"
31009-020	20"
31009-022	22"
31009-024	24"
31009-026	26"
31009-028	28"
31009-030	30"
31009-032	32"
31009-034	34"
31009-036	36"
31009-038	38"
31009-040	40"
31009-042	42"
31009-044	44"
31009-046	46"
31009-048	48"
31009-050	50"
31009-052	52"
31009-054	54"
31009-056	56"
31009-058	58"
31009-060	60"
31009-062	62"
31009-064	64"
31009-066	66"
31009-068	68"
31009-070	70"
31009-072	72"
31009-084	84"

AIR BRAKE HOSE ASSEMBLIES



1/2" HOSE 3/8" NPTF, 2 SWIVELS

P/N	LENGTH
31005-012	12"
31005-014	14"
31005-016	16"
31005-018	18"
31005-020	20"
31005-022	22"
31005-024	24"
31005-026	26"
31005-028	28"
31005-030	30"
31005-032	32"
31005-034	34"
31005-036	36"
31005-038	38"
31005-040	40"
31005-042	42"
31005-044	44"
31005-046	46"
31005-048	48"
31005-050	50"
31005-052	52"
31005-054	54"
31005-056	56"
31005-058	58"
31005-060	60"
31005-062	62"
31005-064	64"
31005-066	66"
31005-068	68"
31005-070	70"
31005-072	72"
31005-084	84"

1/2" HOSE 1/2" NPTF, 2 SWIVELS

P/N	LENGTH
31006-012	12"
31006-014	14"
31006-016	16"
31006-018	18"
31006-020	20"
31006-022	22"
31006-024	24"
31006-026	26"
31006-028	28"
31006-030	30"
31006-032	32"
31006-034	34"
31006-036	36"
31006-038	38"
31006-040	40"
31006-042	42"
31006-044	44"
31006-046	46"
31006-048	48"
31006-050	50"
31006-052	52"
31006-054	54"
31006-056	56"
31006-058	58"
31006-060	60"
31006-062	62"
31006-064	64"
31006-066	66"
31006-068	68"
31006-070	70"
31006-072	72"
31006-084	84"

1/2" HOSE 3/8" & 1/2" NPTF SWIVELS

P/N	LENGTH
31012-012	12"
31012-014	14"
31012-016	16"
31012-018	18"
31012-020	20"
31012-022	22"
31012-024	24"
31012-026	26"
31012-028	28"
31012-030	30"
31012-032	32"
31012-034	34"
31012-036	36"
31012-038	38"
31012-040	40"
31012-042	42"
31012-044	44"
31012-046	46"
31012-048	48"
31012-050	50"
31012-052	52"
31012-054	54"
31012-056	56"
31012-058	58"
31012-060	60"
31012-062	62"
31012-064	64"
31012-066	66"
31012-068	68"
31012-070	70"
31012-072	72"
31012-084	84"

AIR BRAKE HOSE ASSEMBLIES

"5-SERIES" HOSE ASSEMBLIES

FEATURES:

- Innovative, Lightweight Adapter Features the Benefits of a Light Steel Collar and the Cost Advantages of Reduced Material Content.
- Seals with an Internal O-ring.

THESE HOSES ARE AVAILABLE WITH:

- Vibra-Seal Pipe Thread Sealant for Leak-Free Connections
- 3/8" Red & Blue Hose for Easy Line I.D.
- 3/8" Arctic Hose for Low-Temperature Applications (Temps as Low as -65°F)
- Custom Lengths



3/8" HOSE

3/8"-18 NPTF, 1 FIXED 1 SWIVEL

P/N	LENGTH
562366-08	8"
562366-12	12"
562366-14	14"
562366-16	16"
562366-18	18"
562366-20	20"
562366-22	22"
562366-24	24"
562366-26	26"
562366-28	28"
562366-30	30"
562366-32	32"
562366-34	34"
562366-36	36"
562366-38	38"
562366-40	40"
562366-42	42"
562366-44	44"
562366-46	46"
562366-48	48"
562366-50	50"
562366-52	52"
562366-54	54"
562366-56	56"
562366-60	60"
562366-66	66"
562366-72	72"
562366-84	84"

3/8" HOSE

3/8"-18 NPTF, 2 SWIVELS

P/N	LENGTH
563366-08	8"
563366-12	12"
563366-14	14"
563366-16	16"
563366-18	18"
563366-20	20"
563366-22	22"
563366-24	24"
563366-26	26"
563366-28	28"
563366-30	30"
563366-32	32"
563366-34	34"
563366-36	36"
563366-38	38"
563366-40	40"
563366-42	42"
563366-44	44"
563366-46	46"
563366-48	48"
563366-50	50"
563366-52	52"
563366-54	54"
563366-56	56"
563366-60	60"
563366-66	66"
563366-72	72"
563366-84	84"

45° FEMALE FLARE HOSE ASSEMBLIES

FEATURES:

- Increasingly Common Newer Model Trucks & Heavy Duty Equipment
- Various Adapter Ends, Standard 45° Flare Connectors

AVAILABLE WITH:

- 3/8" Red & Blue Hose for Easy Line Identification
- 3/8" Arctic Hose for Low-Temperature Applications (Temps as Low as -65°F)
- Custom Lengths



3/8" HOSE

3/8" FEMALE FLARE SWIVELS

P/N	LENGTH
666600-12	12"
666600-18	18"
666600-20	20"
666600-24	24"
666600-26	26"
666600-28	28"
666600-30	30"
666600-32	32"
666600-34	34"
666600-36	36"
666600-40	40"
666600-42	42"
666600-44	44"
666600-48	48"
666600-54	54"
666600-60	60"
666600-72	72"

1/2" HOSE

1/2" FEMALE FLARE SWIVELS

P/N	LENGTH
688800-16	16"
688800-18	18"
688800-20	20"
688800-22	22"
688800-24	24"
688800-26	26"
688800-28	28"
688800-30	30"
688800-32	32"
688800-34	34"
688800-36	36"
688800-40	40"
688800-42	42"
688800-44	44"
688800-48	48"
688800-52	52"
688800-54	54"
688800-55	55"
688800-60	60"
688800-72	72"



SLIDER (BULKHEAD) HOSE ASSEMBLIES

FEATURES:

- Bulkhead Fittings Enable Quick Connection to Air Brake Tubing
- Reduces Number of Fittings Needed
- Length is Measured from Hex to Hex

THESE HOSES ARE AVAILABLE WITH:

- Spring Guards: Ideal when there is Potential for Hose to Bend Too Tightly, Causing Kinks
- 3/8" Red & Blue Hose for Easy Line Identification
- 3/8" Arctic Hose for Low-Temperature Applications (Temps as Low as -65°F)
- Custom Lengths

3/8" HOSE

CONNECTS TO 3/8" O.D. TUBING

P/N	LENGTH
366600-60	60"
366600-72	72"
366600-78	78"
366600-84	84"
366600-90	90"
366600-96	96"
366600-102	102"
366600-108	108"
366600-114	114"
366600-120	120"
366600-126	126"
366600-132	132"
366600-138	138"
366600-144	144"
366600-160	160"

3/8" HOSE

CONNECTS TO 1/2" O.D. TUBING

P/N	LENGTH
368800-60	60"
368800-72	72"
368800-78	78"
368800-84	84"
368800-90	90"
368800-96	96"
368800-102	102"
368800-108	108"
368800-114	114"
368800-120	120"
368800-126	126"
368800-132	132"
368800-138	138"
368800-144	144"
368800-160	160"



Available with Springs!

AIR BRAKE HOSE ASSEMBLIES



1/2" HOSE

CONNECTS TO 1/2" O.D. TUBING

P/N	LENGTH
388800-60	60"
388800-72	72"
388800-78	78"
388800-84	84"
388800-90	90"
388800-96	96"
388800-102	102"
388800-108	108"
388800-114	114"
388800-120	120"
388800-126	126"
388800-132	132"
388800-138	138"
388800-144	144"
388800-160	160"

1/4" HOSE

CONNECTS TO 3/8" O.D. TUBING

P/N	LENGTH
346600-60	60"
346600-72	72"
346600-78	78"
346600-84	84"
346600-90	90"
346600-96	96"
346600-102	102"
346600-108	108"
346600-114	114"
346600-120	120"
346600-126	126"
346600-132	132"
346600-138	138"
346600-144	144"
346600-160	160"



AIR BRAKE HOSE ASSEMBLIES

SERVICEABLE SLIDER HOSE ASSEMBLIES

FEATURES:

- Bulkhead Fittings Enable Quick Connection to Air Brake Tubing
- Allows Replacement of the Hose without Disturbing the Tubing Connection

THESE HOSES ARE AVAILABLE WITH:

- Spring Guards: Ideal when there is Potential for Hose to Bend Too Tightly, Causing Kinks
- Custom Lengths
- 3/8" Red & Blue Hose for Easy Line I.D.
- 3/8" Arctic Hose for Low-Temperature Applications (Temps as Low as -65°F)



3/8" HOSE

CONNECTS TO 3/8" O.D. TUBING

P/N	LENGTH
32205-60	60"
32205-72	72"
32205-78	78"
32205-84	84"
32205-90	90"
32205-96	96"
32205-102	102"
32205-108	108"
32205-114	114"
32205-120	120"
32205-126	126"
32205-132	132"
32205-138	138"
32205-144	144"
32205-160	160"

3/8" HOSE

CONNECTS TO 1/2" O.D. TUBING

P/N	LENGTH
32206-60	60"
32206-72	72"
32206-78	78"
32206-84	84"
32206-90	90"
32206-96	96"
32206-102	102"
32206-108	108"
32206-114	114"
32206-120	120"
32206-126	126"
32206-132	132"
32206-138	138"
32206-144	144"
32206-160	160"



CRIMPED-ON BULKHEAD HOSES

FEATURES:

Innovative new crimp-on bulkhead combines our best-selling anchor fitting (S611) with our high-quality air brake hose assemblies.

- Eliminates excess components
- Allows connection directly to frame/plate
- Female 1/4" thread allows for numerous plumbing options so that connections can be made to straight, 90° or 45° fittings.
- Reduces the number of potential leak points and reduces the number of fittings in the bill of material

THESE HOSES ARE AVAILABLE WITH:

- 3/8" Red & Blue Hose for Easy Line I.D.
- 3/8" Arctic Hose for Low-Temperature Applications (Temps as Low as -65°F)
- Custom Lengths



TRANSMISSION AIR SHIFT HOSE ASSEMBLIES

FEATURES:

- All-Brass Fittings

THESE HOSES ARE AVAILABLE WITH:

- Vibra-Seal Pipe Thread Sealant for Leak-Free Connections
- Custom Lengths



3/8" HOSE

BULKHEAD & 3/8" SWIVEL FITTING

P/N	LENGTH
563C64-24	24"
563C64-28.5	28.5"
563C64-30	30"
563C64-34.5	34.5"
563C64-36	36"
563C64-48	48"
563C64-60	60"
563C64-72	72"
563C64-84	84"
563C64-96	96"
563C64-108	108"
563C64-120	120"
563C64-132	132"
563C64-144	144"
563C64-156	156"

1/4" HOSE

1/8"-27 NPTF, 1 FIXED 1 SWIVEL

P/N	LENGTH
461112	12"
461115	15"
461116	16"
461117	17"
461118	18"
461120	20"
461124	24"
461126	26"
461127	27"
461128	28"
461129	29"
461130	30"
461132	32"
461134	34"
461136	36"

AIR BRAKE HOSE RACKS



452001



AIR BRAKE HOSE DISPLAY RACK

- Attractive Wall-Mount Display Rack
- Rack Measures 18" Wide
- Holds up to 48 Air Hose Assemblies on 12 Hooks
- 6 Hooks for 3/8" Air Hose Assemblies
- 6 Hooks for 1/2" Air Hose Assemblies
- Each Hook Holds 4 Air Hose Assemblies

P/N	DESCRIPTION
452000	Air Brake Hose Assembly Wall Display Rack

AIR BRAKE HOSE DISPLAY RACKS WITH STOCK

Includes One Display Rack (452000) and Four Each of the Listed Adapter Style Hose Assemblies

452001

P/N	LENGTH	HOSE	FITTINGS
453120	20"	3/8"	1/4" Fixed & Swivel
453124	24"	3/8"	1/4" Fixed & Swivel
453126	26"	3/8"	1/4" Fixed & Swivel
453128	28"	3/8"	1/4" Fixed & Swivel
453130	30"	3/8"	1/4" Fixed & Swivel
453136	36"	3/8"	1/4" Fixed & Swivel
452118	18"	1/2"	3/8" Fixed & Swivel
452120	20"	1/2"	3/8" Fixed & Swivel
452122	22"	1/2"	3/8" Fixed & Swivel
452124	24"	1/2"	3/8" Fixed & Swivel
452126	26"	1/2"	3/8" Fixed & Swivel
452128	28"	1/2"	3/8" Fixed & Swivel

452002

P/N	LENGTH	HOSE	FITTINGS
453320	20"	3/8"	3/8" Swivels
453324	24"	3/8"	3/8" Swivels
453326	26"	3/8"	3/8" Swivels
453328	28"	3/8"	3/8" Swivels
453330	30"	3/8"	3/8" Swivels
453336	36"	3/8"	3/8" Swivels
452130	30"	1/2"	3/8" Fixed & Swivel
452132	32"	1/2"	3/8" Fixed & Swivel
452134	34"	1/2"	3/8" Fixed & Swivel
452136	36"	1/2"	3/8" Fixed & Swivel
452142	42"	1/2"	3/8" Fixed & Swivel
452148	48"	1/2"	3/8" Fixed & Swivel

AIR COMPRESSOR DISCHARGE HOSE ASSEMBLIES

FEATURES:

- Durable Stainless Steel Braided Outer Jacket
- Extruded PTFE Inner Tube Prevents Carbon Build-Up
- Hose Meets All SAE J517 Type 100R14 Requirements
- **Hose Size:** 5/8" O.D., 1/2" I.D.
- **Temperature Range:**
-65°F to 400°F for continuous service
-100°F to 500°F for intermittent service
- Custom lengths available upon request

AIR COMP. DISCHARGE HOSE - SWIVEL BOTH ENDS

5/8" Female Swivel Tube Fittings with 7/8"-14 UN Thread



P/N	DESCRIPTION	LENGTH
462218	Air Compressor Discharge Hose with Female Swivel Fittings	18"
462224	Air Compressor Discharge Hose with Female Swivel Fittings	24"
462230	Air Compressor Discharge Hose with Female Swivel Fittings	30"
462232	Air Compressor Discharge Hose with Female Swivel Fittings	32"
462236	Air Compressor Discharge Hose with Female Swivel Fittings	36"
462242	Air Compressor Discharge Hose with Female Swivel Fittings	42"
462248	Air Compressor Discharge Hose with Female Swivel Fittings	48"
462252	Air Compressor Discharge Hose with Female Swivel Fittings	52"
462254	Air Compressor Discharge Hose with Female Swivel Fittings	54"
462260	Air Compressor Discharge Hose with Female Swivel Fittings	60"
462272	Air Compressor Discharge Hose with Female Swivel Fittings	72"
462284	Air Compressor Discharge Hose with Female Swivel Fittings	84"
4622108	Air Compressor Discharge Hose with Female Swivel Fittings	108"

AIR COMP. DISCHARGE HOSE - TUBE TO COMPRESSION

5/8" Straight Tubes & 5/8" Compression Fittings with 13/16"-18 UN Thread



P/N	DESCRIPTION	LENGTH
462018	Air Compressor Discharge Hose with Tube & Comp. Fitting	18"
462024	Air Compressor Discharge Hose with Tube & Comp. Fitting	24"
462030	Air Compressor Discharge Hose with Tube & Comp. Fitting	30"
462036	Air Compressor Discharge Hose with Tube & Comp. Fitting	36"
462048	Air Compressor Discharge Hose with Tube & Comp. Fitting	48"
462060	Air Compressor Discharge Hose with Tube & Comp. Fitting	60"

AIR COMPRESSOR DISCHARGE HOSE

AIR COMP. DISCHARGE HOSE - COMPRESSION BOTH ENDS

5/8" Compression Fittings with 13/16"-18 UN Threads



P/N	DESCRIPTION	LENGTH
462318	Air Compressor Discharge Hose with Compression Fittings	18"
462324	Air Compressor Discharge Hose with Compression Fittings	24"
462336	Air Compressor Discharge Hose with Compression Fittings	36"

AIR COMP. DISCHARGE HOSE - STRAIGHT TUBE BOTH ENDS

5/8" Straight Tubes



P/N	DESCRIPTION	LENGTH
462118	Air Compressor Discharge Hose with Straight Tubes	18"
462124	Air Compressor Discharge Hose with Straight Tubes	24"
462130	Air Compressor Discharge Hose with Straight Tubes	30"
462136	Air Compressor Discharge Hose with Straight Tubes	36"
462148	Air Compressor Discharge Hose with Straight Tubes	48"

AIR COMP. DISCHARGE HOSE - SWIVEL TO MALE PIPE

5/8" Female Swivel Tube Fittings with 7/8"-14 UN Thread
& 1/2" Male Pipe Thread



P/N	DESCRIPTION	LENGTH
41023-25	Air Compressor Discharge Hose with Female Swivel & Male Pipe	25"
41023-30	Air Compressor Discharge Hose with Female Swivel & Male Pipe	30"
41023-37	Air Compressor Discharge Hose with Female Swivel & Male Pipe	37"
41023-42	Air Compressor Discharge Hose with Female Swivel & Male Pipe	42"
41023-65	Air Compressor Discharge Hose with Female Swivel & Male Pipe	65"

BULK SAE 100R14A PTFE HOSE (AIR COMPRESSOR DISCHARGE HOSE)

P/N	DESCRIPTION	LENGTH	I.D.	O.D.
462000	Bulk Air Compressor Discharge Hose	25 ft.	1/2"	5/8"
462001	Bulk Air Compressor Discharge Hose	100 ft.	1/2"	5/8"
462002	Bulk Air Compressor Discharge Hose	25 ft.	5/8"	3/4"

REUSABLE FITTINGS FOR SAE 100R14A PTFE HOSE (AIR COMPRESSOR DISCHARGE HOSE)

BRASS FERULE

P/N	DESCRIPTION	HOSE I.D.	HOSE O.D.
S51-10B	Brass Ferule	1/2"	5/8"
S51-12B	Brass Ferule	5/8"	3/4"



SOCKET

P/N	DESCRIPTION	HOSE I.D.	HOSE O.D.	THREAD
S52-10	Steel Socket	1/2"	5/8"	13/16"-18 Fem
S52-10C	Stainless Steel Socket	1/2"	5/8"	1-1/16"-14 Fem
S52-12	Steel Socket	5/8"	3/4"	13/16"-18 Fem
S52-12C	Stainless Steel Socket	5/8"	3/4"	1-1/16"-14 Fem



MALE PIPE END

P/N	DESCRIPTION	HOSE I.D.	HOSE O.D.	THREAD
S53-8-10	Male Pipe End Fitting	1/2"	5/8"	1/2"-14



FEMALE JIC SWIVEL

P/N	DESCRIPTION	HOSE I.D.	HOSE O.D.	THREAD
S54-10-10	Female JIC Swivel Fitting	1/2"	5/8"	7/8"-14 Fem
S54-12-12	Female JIC Swivel Fitting	5/8"	3/4"	1-1/16"-14 Fem



STRAIGHT TUBE

P/N	DESCRIPTION	HOSE I.D.	HOSE O.D.	TUBE
S56-10-10	Straight Tube Fitting	1/2"	5/8"	5/8"
S56-12-12	Straight Tube Fitting	5/8"	3/4"	3/4"



SAE COMPRESSION

P/N	DESCRIPTION	HOSE I.D.	HOSE O.D.	THREAD
S57-8-10	SAE Compression Fitting	1/2"	5/8"	11/16"-20
S57-10-10	SAE Compression Fitting	1/2"	5/8"	13/16"-18
S57-12-12	SAE Compression Fitting	5/8"	3/4"	1"-18



GLADHANDS

MANUFACTURING & DISTRIBUTING THE INDUSTRY'S LARGEST SELECTION OF GLADHANDS

Tramec Sloan designs & manufactures gladhands in the USA at our facilities in Holland, Michigan and Lola, Kansas. We provide wide variety of feature combinations to meet your specific needs, including numerous body styles, materials, coatings, seal types and more!

Our gladhands meet DOT and SAE Specs every time.



MANUFACTURING
IN THE U.S.A.



MEETS DOT & SAE
STANDARDS



CORROSION
RESISTANCE



HIGH QUALITY
COMPONENTS

FIGHT CORROSION WITH ANODIZED GLADHANDS

Tramec Sloan's Anodized Gladhands Resist the Corrosion Caused by Magnesium Chloride, Chemicals, and Road Salt.



STANDARD GLADHANDS - ANODIZED

- Stainless Steel Wear Plate
- Wrap-Around, Powder-Coated Clamp Plate Provides Easy Identification and Security

P/N	TYPE	SEAL	FILTER
36101	Service	Rubber	-
36201	Emergency	Rubber	-
36301	Universal	Rubber	-
F36101	Service	Rubber	✓
F36201	Emergency	Rubber	✓
F36301	Universal	Rubber	✓
36101U	Service	Polyurethane	-
36201U	Emergency	Polyurethane	-
36301U	Universal	Polyurethane	-
F36101U	Service	Polyurethane	✓
F36201U	Emergency	Polyurethane	✓
F36301U	Universal	Polyurethane	✓



38° BRACKET MOUNT GLADHANDS - ANODIZED

- Two 3/8" Pipe Thread Ports (One Plug Furnished)
- Mounting Holes: Two .34" Diameter (1" Vertical and 1/4" Offset)
- Wrap-Around, Powder-Coated Clamp Plate Provides Easy Identification and Security
- Stainless Steel Wear Plate
- Back Port is Furnished with Plug

P/N	TYPE	SEAL	FILTER
36161	Service	Rubber	-
36261	Emergency	Rubber	-
F36161	Service	Rubber	✓
F36261	Emergency	Rubber	✓
36161U	Service	Polyurethane	-
36261U	Emergency	Polyurethane	-
F36161U	Service	Polyurethane	✓
F36261U	Emergency	Polyurethane	✓

CORROSION RESISTANT



KNOB-STYLE SHUTOFF GLADHANDS - ANODIZED

- Ideal for Tandem/Double Trailers
- Anodized Knob & Body Resist the Corrosion Caused by Magnesium Chloride, Road Salt & Other Common Chemicals
- Our Spring Detent Knob Design Prevents Valve Rotation Due to Vibration
- Includes 1"-14 Brass Mounting Stud Terminating in a Nylon Tubing Compression Fitting or 3/8" Internal Pipe Thread
- Emergency Gladhand has 1/4" NPT Port for Pintle Hook
- Stainless Steel Ball Valve
- **Knob Replacement Kit P/N: 36159**

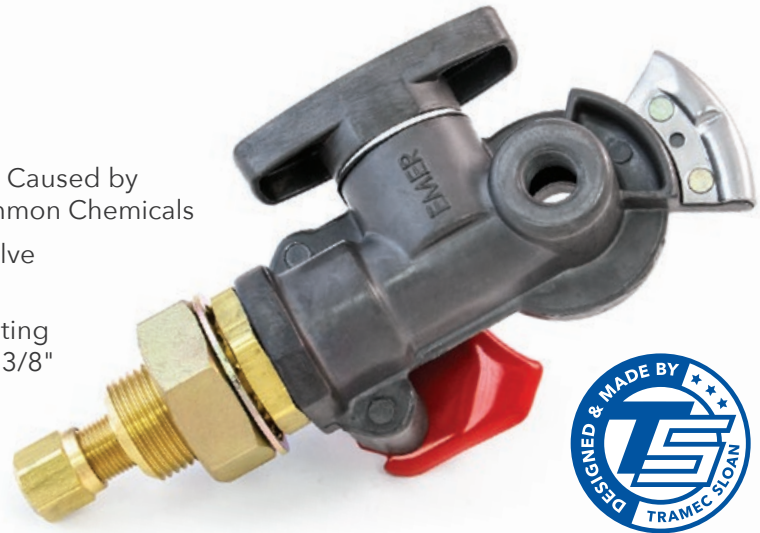

P/N	TYPE	SEAL	FILTER	NYLON TUBE
36153	Service	Rubber	–	3/8" O.D.
36253	Emergency	Rubber	–	3/8" O.D.
36154	Service	Rubber	–	1/2" O.D.
36254	Emergency	Rubber	–	1/2" O.D.
36156	Service	Rubber	–	3/8"-18 NPTF
36256	Emergency	Rubber	–	3/8"-18 NPTF
F36153	Service	Rubber	✓	3/8" O.D.
F36253	Emergency	Rubber	✓	3/8" O.D.
F36154	Service	Rubber	✓	1/2" O.D.
F36254	Emergency	Rubber	✓	1/2" O.D.
F36156	Service	Rubber	✓	3/8"-18 NPTF
F36256	Emergency	Rubber	✓	3/8"-18 NPTF
36153U	Service	Full-Face Polyurethane	–	3/8" O.D.
36253U	Emergency	Full-Face Polyurethane	–	3/8" O.D.
36154U	Service	Full-Face Polyurethane	–	1/2" O.D.
36254U	Emergency	Full-Face Polyurethane	–	1/2" O.D.
36156U	Service	Full-Face Polyurethane	–	3/8"-18 NPTF
36256U	Emergency	Full-Face Polyurethane	–	3/8"-18 NPTF
F36153U	Service	Full-Face Polyurethane	✓	3/8" O.D.
F36253U	Emergency	Full-Face Polyurethane	✓	3/8" O.D.
F36154U	Service	Full-Face Polyurethane	✓	1/2" O.D.
F36254U	Emergency	Full-Face Polyurethane	✓	1/2" O.D.
F36156U	Service	Full-Face Polyurethane	✓	3/8"-18 NPTF
F36256U	Emergency	Full-Face Polyurethane	✓	3/8"-18 NPTF

A TRAMEC SLOAN ORIGINAL

Tramec Sloan developed **the first Knob-Style Shutoff Gladhands** in 1986 as a unique solution to a customer's need. Our design reduces material & installation costs and eliminates the hardware required by other solutions. Years later, these gladhands have become an industry standard!



45° AND 90° SWIVEL GLADHANDS - ANODIZED

- Reduces Stress on the Tractor Air Lines by Swiveling when the Tractor Turns
- Extends Only 2.5" Out from the Mounting Surface Compared to 4" or More for Bracket or Straight Style Gladhands
- Bracket and Steel Mount are Zinc-Plated with Yellow Dichromate
- When Used in Recessed Mounting the Swivel Can Make the Gladhand Nearly Flush when Disconnected
- Spring Made with 302 Stainless Steel for Long Life and Excellent Coil Retention
- Anodized Body Resists the Corrosion Caused by Magnesium Chloride, Road Salt, and Other Common Chemicals

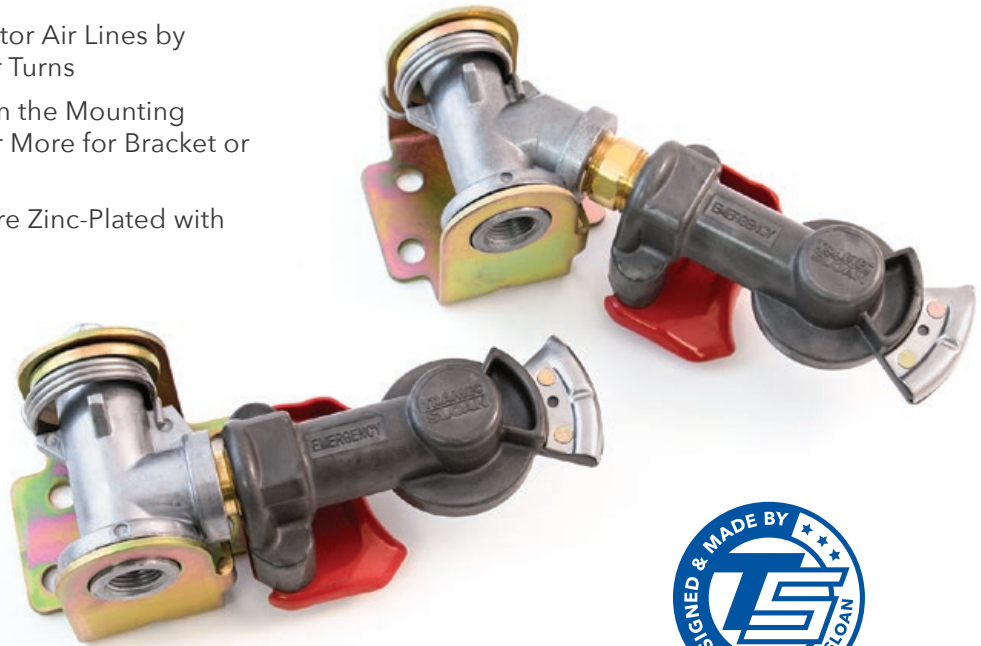

P/N	ANGLE	TYPE	SEAL	FILTER
36181	45°	Service	Rubber	-
36281	45°	Emergency	Rubber	-
36191	90°	Service	Rubber	-
36291	90°	Emergency	Rubber	-
F36181	45°	Service	Rubber	✓
F36281	45°	Emergency	Rubber	✓
F36191	90°	Service	Rubber	✓
F36291	90°	Emergency	Rubber	✓
36181U	45°	Service	Full-Face Polyurethane	-
36281U	45°	Emergency	Full-Face Polyurethane	-
36191U	90°	Service	Full-Face Polyurethane	-
36291U	90°	Emergency	Full-Face Polyurethane	-
F36181U	45°	Service	Full-Face Polyurethane	✓
F36281U	45°	Emergency	Full-Face Polyurethane	✓
F36191U	90°	Service	Full-Face Polyurethane	✓
F36291U	90°	Emergency	Full-Face Polyurethane	✓



A TRAMEC SLOAN ORIGINAL

Tramec Sloan developed **the first 45° & 90° Swing-Away Gladhands** in 1991 to provide a unique solution for a couple of large trailer manufacturers who needed a more economical swivel design. Years later, these gladhands have become an industry standard design!

RAPID-RELEASE™ SERVICE GLADHANDS - ANODIZED

- Releases Trailer Brakes up to 50% Faster than Standard Methods
- Reduces Wear on Drums, Resulting in Maintenance Savings
- Designed to be Used with Both ABS and Non-ABS Brake Systems
- Prevents In-City Trailer Bounce
- Meets SAE J318 Specifications
- Includes Polyurethane Seal with or without Filter
- For Use on Trailers Only
- Rapid-Release Service Kit Includes: Gasket, Snap Ring & Diaphragm



P/N	DESCRIPTION	STYLE	SEAL	FILTER
441175	Rapid-Release Gladhand	Standard	Blue Polyurethane	✓
441176	Rapid-Release Gladhand	Standard	Blue Polyurethane	-
441177	Rapid-Release Gladhand	37.5° Bracket Mount	Blue Polyurethane	✓
441178	Rapid-Release Gladhand	37.5° Bracket Mount	Blue Polyurethane	-
441233	Rapid-Release Gladhand	Swing-Away with Stopper	Blue Polyurethane	✓
451715	Service Kit	-	-	-

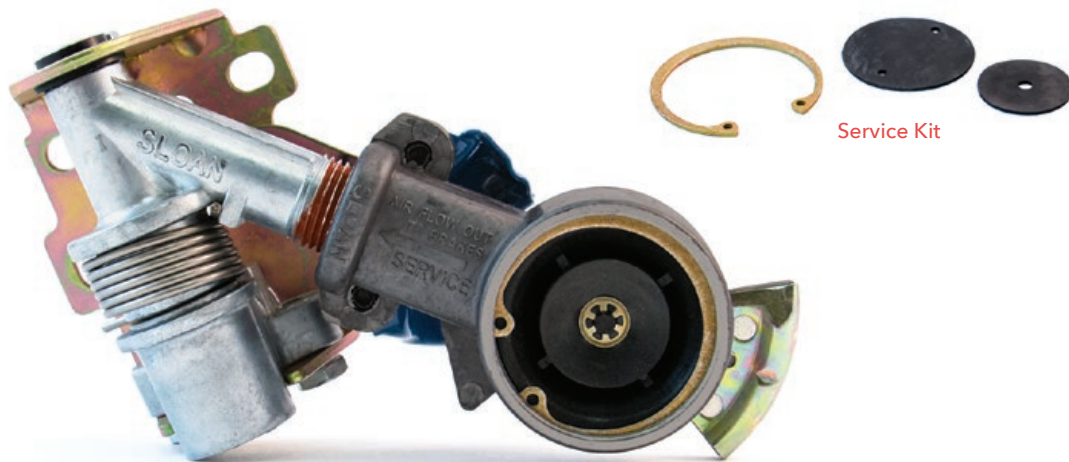

STANDARD GLADHANDS With Cast-In Stainless Steel Wear Plate

- Die Cast Aluminum Finish
- Powder-Coated Clamp Plate for Easy Identification
- Available with Body Powder-Coating for Easy Identification & Additional Corrosion Resistance
- Available with Stainless Steel Filters for Added Air Line Protection from Debris & Insects
- Available with Rubber, Polyurethane or Polyurethane+Filter Combo Seals



P/N	BODY	TYPE	SEAL	FILTER
441015•	Die-Cast Aluminum	Service	Rubber	–
441016•	Die-Cast Aluminum	Emergency	Rubber	–
441017•	Die-Cast Aluminum	Universal	Rubber	–
441050•	Die-Cast Aluminum	Emergency	Rubber	✓
441051•	Die-Cast Aluminum	Service	Rubber	✓
441052	Die-Cast Aluminum	Universal	Rubber	✓
441056•	Die-Cast Aluminum	Service	Blue Polyurethane	–
441057•	Die-Cast Aluminum	Emergency	Red Polyurethane	–
441058•	Die-Cast Aluminum	Service	Black Polyurethane	–
441059•	Die-Cast Aluminum	Emergency	Black Polyurethane	–
441060•	Die-Cast Aluminum	Universal	Black Polyurethane	–
441145*	Die-Cast Aluminum	Universal	Rubber	–
441114	Die-Cast Aluminum	Service	Blue Polyurethane	✓
441115	Die-Cast Aluminum	Emergency	Red Polyurethane	✓
441261	Die-Cast Aluminum	Universal	Black Polyurethane	✓
441252	Die-Cast Aluminum	Service	Blue Polyurethane	✓
441253	Die-Cast Aluminum	Emergency	Red Polyurethane	✓
441209	Die-Cast Aluminum	Service	Black Poly Protect-o Seal	–
441210	Die-Cast Aluminum	Emergency	Black Poly Protect-o Seal	–
441211	Die-Cast Aluminum	Universal	Black Poly Protect-o Seal	–
441078•	Powder-Coated Aluminum	Service	Blue Polyurethane	–
441079•	Powder-Coated Aluminum	Emergency	Red Polyurethane	–
441093•	Powder-Coated Aluminum	Service	Black Polyurethane	–
441094•	Powder-Coated Aluminum	Emergency	Black Polyurethane	–
441141	Powder-Coated Aluminum	Service	Blue Polyurethane	✓
441142	Powder-Coated Aluminum	Emergency	Red Polyurethane	✓

* Reducer Fitting with 1/4" Main Port

• Items Available in Quantity of 100. Order with Suffix "-100"

STANDARD GLADHANDS

With Riveted Stainless Steel Wear Plate

- Burnished Aluminum Finish
- Wrap-Around, Powder-Coated Clamp Plate Provides Easy Identification and Security

P/N	TYPE	SEAL	FILTER
56101	Service	Rubber	-
56201	Emergency	Rubber	-
56301	Universal	Rubber	-
F56101	Service	Rubber	✓
F56201	Emergency	Rubber	✓
F56301	Universal	Rubber	✓
56101U	Service	Polyurethane	-
56201U	Emergency	Polyurethane	-
56301U	Universal	Polyurethane	-
F56101U	Service	Polyurethane	✓
F56201U	Emergency	Polyurethane	✓
F56301U	Universal	Polyurethane	✓



TS TECH TIPS:

Gladhand Maintenance & Inspection:

- Dried out or cracked seals won't create a proper seal, causing air leaks. Aim to replace gladhand seals every 6 months.
- Have you noticed that your gladhands aren't forming a firm connection anymore? This is a sure sign it's time for replacement!
- Rusted clamps and wear plates contribute to loose connections and pose a risk for debris in your lines.



CAST-IRON STANDARD GLADHANDS

- Constructed of Die-Cast Malleable Iron
- Zinc & Yellow Dichromate Plated for Added Corrosion Resistance
- Comes Standard with Long-Lasting Polyurethane Seal
- Available with Powder-Coating for Easy Identification and Additional Corrosion Resistance



P/N	BODY	TYPE	SEAL	FILTER
441088•	2-Piece	Emergency	Red Polyurethane	–
441089•	2-Piece	Emergency	Black Polyurethane	–
441090•	2-Piece	Service	Blue Polyurethane	–
441091•	2-Piece	Service	Black Polyurethane	–
441092•	2-Piece	Universal	Black Polyurethane	–
441131•	1-Piece	Service	Blue Polyurethane	–
441132•	1-Piece	Emergency	Red Polyurethane	–
441133•	1-Piece	Universal	Black Polyurethane	–
441818	2-Piece Powder-Coated	Emergency	Red Polyurethane	–
441819	2-Piece Powder-Coated	Service	Blue Polyurethane	–
441820	1-Piece Powder-Coated	Service	Blue Polyurethane	–
441821	1-Piece Powder-Coated	Emergency	Red Polyurethane	–
441203	2-Piece	Emergency	Red Polyurethane	✓
441089F	2-Piece	Emergency	Black Polyurethane	✓
441204	2-Piece	Service	Blue Polyurethane	✓
441091F	2-Piece	Service	Black Polyurethane	✓
441262	2-Piece	Universal	Black Polyurethane	✓
F56121	1-Piece	Service	Black Polyurethane	✓
F56221	1-Piece	Emergency	Black Polyurethane	✓
F56321	1-Piece	Universal	Black Polyurethane	✓
441263	2-Piece Powder-Coated	Emergency	Red Polyurethane	✓
441264	2-Piece Powder-Coated	Service	Blue Polyurethane	✓
F56121P	1-Piece Powder-Coated	Service	Black Polyurethane	✓
F56221P	2-Piece Powder-Coated	Emergency	Black Polyurethane	✓

• Items Available in Quantity of 40. Order with Suffix "-40"

SWING-AWAY GLADHANDS

45° & 90° with Optional Stopper Arm

- Reduces Stress on the Tractor Air Lines by Swiveling when the Tractor Turns
- Swing-Away Gladhands Rotate 180° for Easy Air Line Coupling
- Extends Only 2.5" Out from the Mounting Surface Compared to 4" or More for Bracket or Straight-Style Gladhands
- When Used in Recessed Mounting the Swivel Can Make the Gladhand Nearly Flush when Disconnected
- Spring Made with 302 Stainless Steel for Long Life & Excellent Coil Retention
- Bracket and Steel Mount are Zinc-Plated with Yellow Dichromate



TRAMEC SLOAN ORIGINAL

Tramec Sloan Designed the First 45° & 90° Swing-Away Gladhands as a Unique Solution to a Customer's Problem. Years later, the Gladhands have Become Industry Standards!

45° AND 90° STOPPER ARMS

- Prevent Debris from Entering Your Air Lines!
- Stopper Arms Provide a Neoprene Cover for the Gladhand Seal when the Trailer is Parked
- Arm Shares Bolts with the Swivel Mount



36181P

P/N	DESCRIPTION
36385	Arm for 45° Swivel Mount
36395	Arm for 90° Swivel Mount



56291

45° AND 90° SWIVEL MOUNTS

Use with Your Own Gladhand to Create a Custom Swing-Away!



F36292

P/N	DESCRIPTION
36380	45° Swivel Mount
36390	90° Swivel Mount

45° AND 90° SWING-AWAY GLADHANDS

with Optional Stopper Arm

P/N	BODY	ANGLE	TYPE	SEAL	FILTER
56181	Aluminum	45°	Service	Rubber	–
56281	Aluminum	45°	Emergency	Rubber	–
56191	Aluminum	90°	Service	Rubber	–
56291	Aluminum	90°	Emergency	Rubber	–
F56181	Aluminum	45°	Service	Rubber	✓
F56281	Aluminum	45°	Emergency	Rubber	✓
F56191	Aluminum	90°	Service	Rubber	✓
F56291	Aluminum	90°	Emergency	Rubber	✓
56181U	Aluminum	45°	Service	Full-Face Polyurethane	–
56281U	Aluminum	45°	Emergency	Full-Face Polyurethane	–
56191U	Aluminum	90°	Service	Full-Face Polyurethane	–
56291U	Aluminum	90°	Emergency	Full-Face Polyurethane	–
F56181U	Aluminum	45°	Service	Full-Face Polyurethane	✓
F56281U	Aluminum	45°	Emergency	Full-Face Polyurethane	✓
F56191U	Aluminum	90°	Service	Full-Face Polyurethane	✓
F56291U	Aluminum	90°	Emergency	Full-Face Polyurethane	✓
36181P	Powder-Coated Aluminum	45°	Service	Rubber	–
36281P	Powder-Coated Aluminum	45°	Emergency	Rubber	–
36191P	Powder-Coated Aluminum	90°	Service	Rubber	–
36291P	Powder-Coated Aluminum	90°	Emergency	Rubber	–
F36181P	Powder-Coated Aluminum	45°	Service	Rubber	✓
36281P	Powder-Coated Aluminum	45°	Emergency	Rubber	✓
F36191P	Powder-Coated Aluminum	90°	Service	Rubber	✓
F36291P	Powder-Coated Aluminum	90°	Emergency	Rubber	✓
36181UP	Powder-Coated Aluminum	45°	Service	Full-Face Polyurethane	–
36281UP	Powder-Coated Aluminum	45°	Emergency	Full-Face Polyurethane	–
36191UP	Powder-Coated Aluminum	90°	Service	Full-Face Polyurethane	–
36291UP	Powder-Coated Aluminum	90°	Emergency	Full-Face Polyurethane	–
F36181UP	Powder-Coated Aluminum	45°	Service	Full-Face Polyurethane	✓
F36281UP	Powder-Coated Aluminum	45°	Emergency	Full-Face Polyurethane	✓
F36191UP	Powder-Coated Aluminum	90°	Service	Full-Face Polyurethane	✓
F36291UP	Powder-Coated Aluminum	90°	Emergency	Full-Face Polyurethane	✓
36182	Cast Iron	45°	Service	Blue Polyurethane	–
36282	Cast Iron	45°	Emergency	Red Polyurethane	–
36192	Cast Iron	90°	Service	Blue Polyurethane	–
36292	Cast Iron	90°	Emergency	Red Polyurethane	–
F36182	Cast Iron	45°	Service	Blue Polyurethane	✓
F36282	Cast Iron	45°	Emergency	Red Polyurethane	✓
F36192	Cast Iron	90°	Service	Blue Polyurethane	✓
F36292	Cast Iron	90°	Emergency	Red Polyurethane	✓

HEAVY BRASS NIPPLE

For Use with Swivel Mounts to Connect a Gladhand.

P/N	DESCRIPTION
3638005	1.5" Heavy Brass Nipple
3638006	1.12" Heavy Brass Nipple



SWIVEL TUBING ADAPTERS

Brass swivel adapters convert 3/8" NPTF to nylon air brake connectors for both 3/8" and 1/2" O.D. to prevent twisting the tubing.

P/N	DESCRIPTION	TUBE O.D.
55243	Straight Swivel Fitting	3/8"
55244	Straight Swivel Fitting	1/2"
55286	45° Swivel Fitting	3/8"
55287	45° Swivel Fitting	1/2"
55290	90° Swivel Fitting	3/8"
55291	90° Swivel Fitting	1/2"

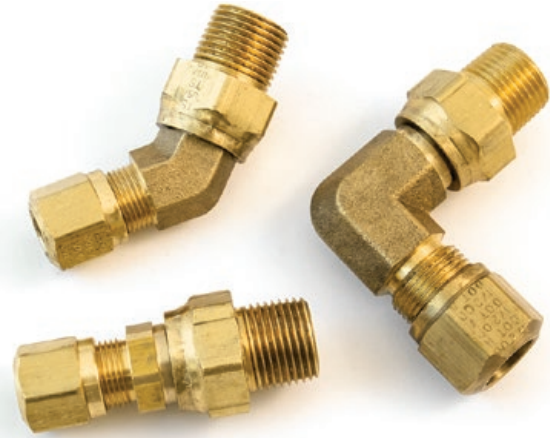

SWIVEL GLADHANDS

- Ideal for Intermodals
- Cast Iron Bodies are Zinc-Plated with Yellow Dichromate for Corrosion Resistance
- Mounting Holes: Two .34" Diameter (1" Vertical and 1/4" Offset)
- Stainless Steel Return Spring



P/N	BODY	TYPE	SEAL	FILTER
36131	Cast Iron	Service	Rubber	-
36231	Cast Iron	Emergency	Rubber	-
36131P	Powder-Coated Cast Iron	Service	Rubber	-
36231P	Powder-Coated Cast Iron	Emergency	Rubber	-
F36131	Cast Iron	Service	Rubber	✓
F36231	Cast Iron	Emergency	Rubber	✓
F36131P	Powder-Coated Cast Iron	Service	Rubber	✓
F36231P	Powder-Coated Cast Iron	Emergency	Rubber	✓
36131U	Cast Iron	Service	Full-Face Polyurethane	-
36231U	Cast Iron	Emergency	Full-Face Polyurethane	-
36131UP	Powder-Coated Cast Iron	Service	Full-Face Polyurethane	-
36231UP	Powder-Coated Cast Iron	Emergency	Full-Face Polyurethane	-
F36131U	Cast Iron	Service	Full-Face Polyurethane	✓
F36231U	Cast Iron	Emergency	Full-Face Polyurethane	✓
F36131UP	Powder-Coated Cast Iron	Service	Full-Face Polyurethane	✓
F36231UP	Powder-Coated Cast Iron	Emergency	Full-Face Polyurethane	✓

FILTER FOR CAST IRON SWIVEL

P/N	DESCRIPTION
3600024	Filter for Iron Swivel

SWING-AWAY GLADHANDS

45° & 90° with Built-In Stopper Arm

- Reduces Stress on the Tractor Air Lines by Swiveling when Turning
- Swing-Away Gladhands Rotate 180° for Easy Air Line Coupling
- Extends Only 2.5" Out from the Mounting Surface Compared to 4" or More for Bracket or Straight-Style Gladhands
- When Used in Recessed Mounting the Swivel Can Make the Gladhand Nearly Flush when Disconnected
- Built-In Stopper Prevents Foreign Particles & Insects from Entering Air Lines While Trailer is Not in Use
- Bottom Port Does Not Swivel which allows for the Use of a Direct Nylon Tubing Connection
- Air Line Entry from Either the Bottom or Back Port
- Both Ports are 3/8"-18 NPTF

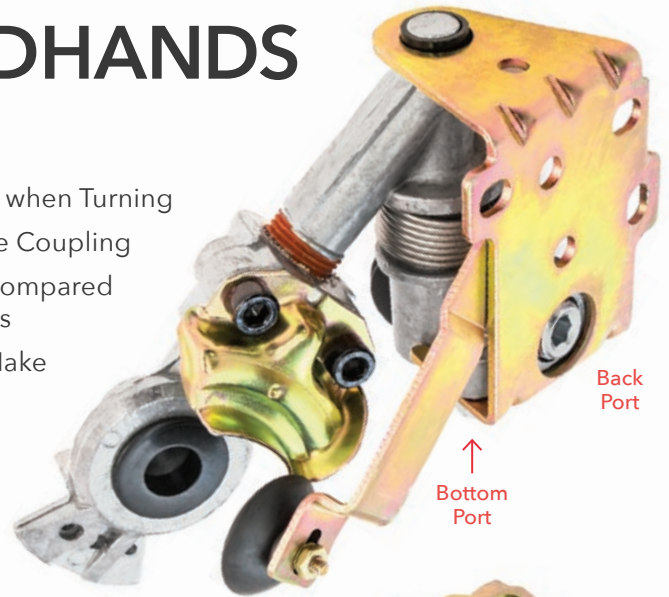

P/N	BODY	ANGLE	TYPE	SEAL	OPEN PORT
441062	Aluminum	45°	Service	Black Polyurethane	Bottom
441063	Aluminum	45°	Emergency	Black Polyurethane	Bottom
441064	Aluminum	45°	Universal	Black Polyurethane	Bottom
441069	Aluminum	45°	Emergency	Red Polyurethane	Bottom
441070	Aluminum	45°	Service	Blue Polyurethane	Bottom
441102	Aluminum	45°	Service	Black Polyurethane	Back
441103	Aluminum	45°	Emergency	Black Polyurethane	Back
441104	Aluminum	45°	Universal	Black Polyurethane	Back
441105	Aluminum	45°	Emergency	Red Polyurethane	Back
441106	Aluminum	45°	Service	Blue Polyurethane	Back
441150	Cast Iron	45°	Service	Blue Polyurethane	Bottom
441151	Cast Iron	45°	Emergency	Red Polyurethane	Bottom
441152	Cast Iron	45°	Service	Blue Polyurethane	Back
441153	Cast Iron	45°	Emergency	Red Polyurethane	Back
441154	Cast Iron	45°	Service	Blue Polyurethane	Both
441155	Cast Iron	45°	Emergency	Red Polyurethane	Both
441248	Aluminum	90°	Service	Blue Polyurethane	Bottom
441249	Aluminum	90°	Emergency	Red Polyurethane	Bottom
441265	Aluminum	90°	Service	Blue Polyurethane	Back
441266	Aluminum	90°	Emergency	Red Polyurethane	Back
441250	Anodized Aluminum	45°	Service	Blue Polyurethane	Bottom
441251	Anodized Aluminum	45°	Emergency	Red Polyurethane	Bottom
441766					

Replacement Dust Cover for Built-In Stopper Arm

38° BRACKET-MOUNT GLADHANDS with Cast-In Stainless Steel Wear Plate

- Two 3/8" Pipe Thread Ports (One Plug Furnished)
- Available with Stainless Steel Filters for Added Air Line Protection from Debris & Insects
- Available with Rubber, Polyurethane or Polyurethane+Filter Combo Seals



P/N	BODY	TYPE	SEAL	FILTER	OPEN PORT
441018•	Aluminum	Emergency	Rubber	✓	Bottom
441019•	Aluminum	Emergency	Rubber	-	Bottom
441022•	Aluminum	Service	Rubber	✓	Bottom
441023•	Aluminum	Service	Rubber	-	Bottom
441024	Aluminum	Emergency	Rubber	✓	Back
441025	Aluminum	Emergency	Rubber	-	Back
441026	Aluminum	Service	Rubber	✓	Back
441027	Aluminum	Emergency	Rubber	-	Back
441065•	Aluminum	Service	Red Polyurethane	-	Bottom
441066•	Aluminum	Emergency	Blue Polyurethane	-	Bottom
441067•	Powder-Coated Aluminum	Service	Blue Polyurethane	-	Bottom
441068•	Powder-Coated Aluminum	Emergency	Red Polyurethane	-	Bottom
441074•	Aluminum	Service	Red Polyurethane	✓	Bottom
441075•	Aluminum	Emergency	Blue Polyurethane	✓	Bottom
441098••	Powder-Coated Aluminum	Service	Blue Polyurethane	✓	Bottom
441099••	Powder-Coated Aluminum	Emergency	Red Polyurethane	✓	Bottom
441214	Aluminum	Service	Blue Polyurethane	✓	Back
441215	Aluminum	Emergency	Red Polyurethane	✓	Back

• Items Available in Quantity of 80. Order with Suffix "-80"

•• Items Available in Quantity of 63. Order with Suffix "-63"



38° BRACKET-MOUNT GLADHANDS with Riveted Stainless Steel Wear Plate

- Two 3/8" Pipe Thread Ports: Back Plug Furnished
- Mounting Holes: Two .34" Diameter (1" Vertical and 1/4" Offset)
- Available with Stainless Steel Filters for Added Air Line Protection from Debris & Insects
- Available with Rubber, Polyurethane or Polyurethane+Filter Combo Seals



P/N	BODY	TYPE	SEAL	FILTER
56161	Aluminum	Service	Rubber	-
56261	Aluminum	Emergency	Rubber	-
36161P	Powder-Coated Aluminum	Service	Rubber	-
36261P	Powder-Coated Aluminum	Emergency	Rubber	-
F56161	Aluminum	Service	Rubber	✓
F56261	Aluminum	Emergency	Rubber	✓
F36161P	Powder-Coated Aluminum	Service	Rubber	✓
F36261P	Powder-Coated Aluminum	Emergency	Rubber	✓
56161U	Aluminum	Service	Full-Face Polyurethane	-
56261U	Aluminum	Emergency	Full-Face Polyurethane	-
36161UP	Powder-Coated Aluminum	Service	Full-Face Polyurethane	-
36261UP	Powder-Coated Aluminum	Emergency	Full-Face Polyurethane	-
F56161U	Aluminum	Service	Full-Face Polyurethane	✓
F56261U	Aluminum	Emergency	Full-Face Polyurethane	✓
F36161UP	Powder-Coated Aluminum	Service	Full-Face Polyurethane	✓
F36261UP	Powder-Coated Aluminum	Emergency	Full-Face Polyurethane	✓



SWING-AWAY SHUT-OFF GLADHANDS

45° with Stopper Arm

- Shut-Off Valve Prevents Contaminants from Entering the System
- Eliminates the Need for a Dummy Coupler
- Decreases Plumbing Hardware and Speeds Installation Time
- Stopper Arm Provides A Neoprene Cover for the Face of the Gladhand Seal when not in Use.

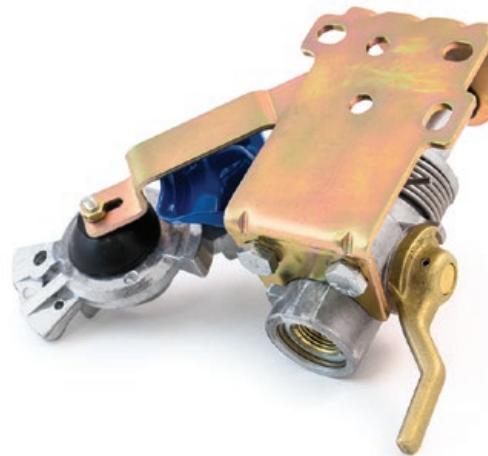

P/N	BODY	TYPE	SEAL	FILTER
441169	Cast Iron	Service	Blue Polyurethane	-
441170	Cast Iron	Emergency	Red Polyurethane	-
441171	Aluminum	Service	Black Polyurethane	-
441172	Aluminum	Emergency	Black Polyurethane	-
441199	Cast Iron	Service	Blue Polyurethane	✓
441200	Cast Iron	Emergency	Red Polyurethane	✓
441267	Aluminum	Service	Black Polyurethane	✓
441268	Aluminum	Emergency	Black Polyurethane	✓

BULKHEAD LEVER STYLE SHUT-OFF GLADHANDS

- Constructed of Die Cast Aluminum with Stainless Steel Wear Plates
- Emergency Gladhands have 1/4" Port for Pintle Hook



P/N	TYPE	SEAL	FEATURES
441148	Service	Rubber	3/8" Nylon Tube Fitting
441149	Emergency	Rubber	3/8" Nylon Tube Fitting
441161	Service	Rubber	1/2" Nylon Tube Fitting
441161L	Service	Rubber	1/2" Nylon Tube Fitting & Long Handle
441162	Emergency	Rubber	1/2" Nylon Tube Fitting
441162L	Emergency	Rubber	1/2" Nylon Tube Fitting & Long Handle
441164	Service	Rubber	3/8" NPTF Port
441164L	Service	Rubber	3/8" NPTF Port & Long Handle
441165	Emergency	Rubber	3/8" NPTF Port & Long Handle
441165L	Emergency	Rubber	3/8" NPTF Port & Long Handle
441212	Service	Rubber	3/8" NPTF Port & 3/8" Nylon Tube Fitting with Long Handle
441234	Emergency	Rubber	3/8" NPTF Port & 3/8" Nylon Tube Fitting with Long Handle
441213	Service	Rubber	3/8" NPTF Port & 1/2" Nylon Tube Fitting with Long Handle
441235	Emergency	Rubber	3/8" NPTF Port & 1/2" Nylon Tube Fitting with Long Handle

LEVER STYLE SHUT-OFF GLADHANDS

- Ideal for Tandem/Double Trailer
- Constructed of Aluminum with Cast-In Stainless Steel Wear Plates or Ultra- Lightweight Composite Material with Riveted Stainless Steel Wear Plates
- Metal Inner Ball Valve
- Emergency Gladhands have 1/4" Port for Pintle Hook



TRAMEC SLOAN ORIGINAL

Years Ago, Tramec Sloan Designed **the First Shut-Off Gladhand** as a Unique Solution to a Customer's Problem. Years later, the Gladhands have Become Industry Standards!



P/N	BODY	TYPE	SEAL	PLUG	Fitting
441000	Aluminum	Service	Rubber	Not Required	3/8" Copper
441001•	Aluminum	Service	Rubber	Not Required	3/8" Nylon
441003•	Aluminum	Service	Rubber	Not Required	1/2" Nylon
441004•	Aluminum	Service	Rubber	Not Required	None
441005•	Aluminum	Emergency	Rubber	Yes	3/8" Copper
441007•	Aluminum	Emergency	Rubber	No	3/8" Copper
441008•	Aluminum	Emergency	Rubber	No	3/8" Nylon
441012•	Aluminum	Emergency	Rubber	No	1/2" Nylon
441014•	Aluminum	Emergency	Rubber	No	None
441071	Aluminum	Emergency	Red Polyurethane	Not Required	3/8"-18 Port
441072	Aluminum	Service	Blue Polyurethane	Not Required	3/8"-18 Port
441080	Aluminum	Emergency	Black Polyurethane	Not Required	3/8"-18 Port
441081	Aluminum	Service	Black Polyurethane	Not Required	3/8"-18 Port
441205	Aluminum	Service	Rubber Protect-o, No Filter	Not Required	1/2" Nylon
441206	Aluminum	Emergency	Rubber Protect-o, No Filter	Not Required	1/2" Nylon
441207	Aluminum	Service	Rubber Protect-o	No	None
441208	Aluminum	Emergency	Rubber Protect-o	No	None
441224	Aluminum	Service	Poly Protect-o with Filter	Not Required	None
441225	Aluminum	Emergency	Poly Protect-o with Filter	Not Required	None
GH1004	Composite	Service	Blue Poly	Not Required	None
GH1014	Composite	Emergency	Red Poly	No	None

• Items Available in Quantity of 50. Order with Suffix "-50"

REPLACEMENT SHUT-OFF HANDLE

P/N	DESCRIPTION
441750	Replacement Handle for Shut-Off Style Gladhands



TS
TS
TS

THE MAXXGRIP™

Tramec Sloan's Innovative Gladhand for Safer & More Complete Connections

- Provides Easier Coupling & Uncoupling with Added Leverage
- Ergonomic Grip Reduces the Chance of Kinking Airlines & Extends Their Life
- Integrated Hex at the Base Provides for Easy Installation
- Eliminates the Potential Leak Point Between Gladhand & Grip



1. POWDER-COATED ALUMINUM

Provides Instant Line Identification & Added Protection Against Corrosion

2. ALUMINUM

Light-Weight & Durable with Cast-In Stainless Steel Wear Plates

3. ANODIZED ALUMINUM

Features *Superior* Corrosion & Salt Spray Resistance for Harsh Winter Conditions

4. POWDER-COATED CAST IRON

1-Piece, Solid-Body Design & a Long-Lasting Polyurethane Seal

MAXXGRIP™ GLADHANDS

P/N	TYPE	MATERIAL	WEAR PLATE
441222	Emergency	Die-Cast Aluminum	Cast-In Stainless Steel
441223	Service	Die-Cast Aluminum	Cast-In Stainless Steel
441226	Service	Blue Powder-Coated Aluminum	Cast-In Stainless Steel
441227	Emergency	Red Powder-Coated Aluminum	Cast-In Stainless Steel
441240	Service	Blue Powder-Coated Cast Iron	Cast Iron
441241	Emergency	Red Powder-Coated Cast Iron	Cast Iron
441242	Service	Anodized Aluminum	Stainless Steel*
441243	Emergency	Anodized Aluminum	Stainless Steel*

* Secured with Nickel-Plated Screws

"Awesome Product. Really Helps Eliminate the Chances of Kinking."

"We Really Like that there's Only One Air Connection Instead of Two."



MAXXGRIP™ RETAIL COMBO PACKS

P/N	DESCRIPTION
441228	Aluminum MAXXGrip Retail Combo Pack - 1 Service & 1 Emergency Gladhand
441229	Powder-Coated MAXXGrip Retail Combo Pack - 1 Service & 1 Emergency Gladhand
441228-10	Display Refill: 10 Aluminum MAXXGrip Retail Combo Packs
441229-10	Display Refill: 10 Powder-Coated MAXXGrip Retail Combo Packs

MAXXGRIP™ RETAIL DISPLAYS

- Put them on the counter and they sell themselves. Once they're seen, they're sold!
- Display rack holds 10 packs and features a tethered MAXXGrip™ for your customers to try out.

P/N	DESCRIPTION
441244	MAXXGrip Display Rack with Stock: 10 Aluminum Combo Packs 441228
441245	MAXXGrip Display Rack with Stock: 10 Powder-Coated Combo Packs 441229
441246	MAXXGrip Display Rack w/ Mixed Stock: 5 Aluminum & 5 Powder-Coated Combo Packs
441247	MAXXGrip Display Rack without Stock

LOOKING FOR MORE MAXXGRIP?

You Can Also Find MAXXGrips on Our 3-in-1 and 4-in-1 Wraps and on Our Tractor-to-Trailer Hose Assemblies!

3-in-1 & 4-in-1 Wraps: Pages 6-13

Tractor-to-Trailer Hoses: Pages 14-18

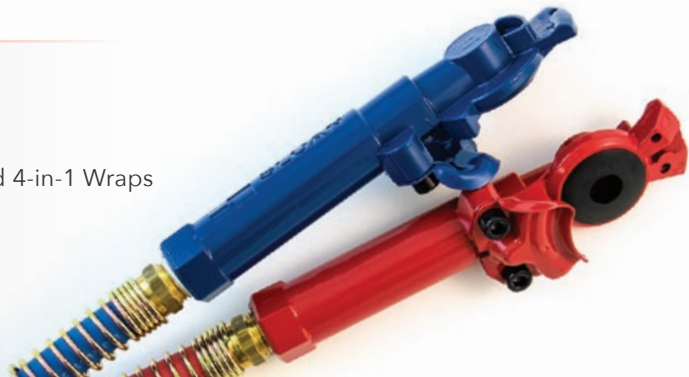

DURA-GRIP™ HANDLES

- Provides Leverage to Prevent Airlines from Kinking at the Gladhand Connection
- Color-Coded Red & Blue Plastic Handles Resist Cracking in Subzero Temperatures
- Includes Mounting Hardware
- Installs in Minutes Between the Gladhand and Air Line with Standard Tools
- Pre-Applied Thread Sealant on Fittings Prevents Air Leaks
- Packaged in a Retail Friendly Display Pack
- 1/2" Male Threads on Gladhand End
- 1/2" Female Threads on Air Line End
- **Display Rack:** Holds 12 Dura-Grip Packs and Can Sit on a Countertop or be Wall-Mounted



P/N	DESCRIPTION
441751	Dura-Grip Handle Set
441751-12	Bulk Dura-Grip Handles, 12 Sets
441129	Dura-Grip Display Rack without Stock
441130	Dura-Grip Display Rack with Stock

ALUMINUM DURA-GRIP™ HANDLES

- Durable and Attractive with a Textured Surface to Provide Extra Grip
- Red & Blue Protective Finish Helps You Quickly Identify Your Lines
- Easy to Install
- 1/2" Male Threads on Gladhand End
- 1/2" Female Threads on Air Line End



P/N	DESCRIPTION
441799	Aluminum Dura-Grip Handle Set
441799-12	Aluminum Dura-Grip Handles, 12 Sets



GLADHAND PACIFIER

- Keeps Airlines and Exposed Gladhands Free from Dirt, Insects and Moisture
- 2-piece Nylon Strap Keeps Pacifier Handy when the Airline System is Connected or Disconnected
- Can be Used on Any Gladhand



P/N	DESCRIPTION
441721	Gladhand Pacifier



GLADHAND LOCKS

Place the Lock onto the Emergency Side Gladhand to Prevent Unwanted Trailer Connections.

- Fits Most Makes of Gladhands
- Supplied with Two Keys
- Not Intended as an Anti-Theft Device

P/N	DESCRIPTION
441752-01	Gladhand Lock Key #1, Retail Package
441752-03	Gladhand Lock Key #3, Retail Package
59001-MA141	Gladhand Lock Keyed #141
59001-MA145	Gladhand Lock Keyed #145
59001-MA150	Gladhand Lock Keyed #150
59001-MA160	Gladhand Lock Keyed #160



KING PIN LOCK

- Prevents Unwanted Trailer Connections
- Supplied with Two Keys
- Keyed Alike

P/N	DESCRIPTION
451101	King Pin Lock

DUMMY GLADHANDS

- Ideal for Tandem/Double Trailers when Shut Off Gladhands are Not Used
- Cables are Nylon Coated Galvanized Steel



36401



36406



36413



36416



441047



441822

P/N	DESCRIPTION
36401	Closed Universal Gladhand With Handle
36406	Vented Stamped Dummy Gladhand with 9.34" Chain
36407	Non-Vented Stamped Dummy Gladhand with 9.34" Chain
36413	Closed Universal Gladhand With Handle (36401) with 18" x 1/8" O.D. Cable
36416	Solid Cast Aluminum Universal Gladhand with Handle (36420) with 18" x 1/8" O.D. Cable
36420	Solid Cast Aluminum Universal Gladhand with Handle
441047•	Closed Universal Gladhand with Handle and 18" Cable
441822•	Solid Dummy Gladhand with 16" Cable
441824	"Stop Do Not Hook" Sign with Dummy Gladhand (441822)

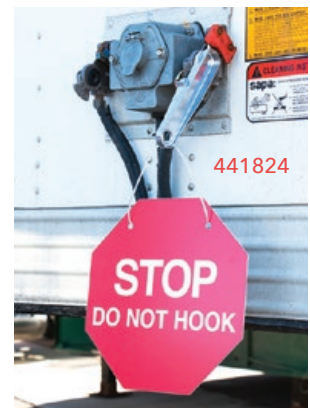

441824

• Items Available in Quantity of 50. Order with Suffix "-50"

FULL-FACE GLADHAND SEALS

The Wide Diameter of these Seals Provide Maximum Coverage on the Face of Your Gladhand



P/N	DESCRIPTION
441749•	Black Full-Face Rubber Gladhand Seal
36010	Gray Full-Face Poly Gladhand Seal
36011	Blue Full-Face Poly Gladhand Seal
36012	Red Full-Face Poly Gladhand Seal

• Items Available in Quantity of 100. Order with Suffix "-100"

PROTECT-O SEALS

Molded-In Center Flaps Prevent Dust and Debris from Entering Your Airlines



P/N	DESCRIPTION
441736•	Black Rubber Protect-O Seal
441790	Black Polyurethane Protect-O Seal
441843•	Blue Polyurethane Protect-O Seal
441844•	Red Polyurethane Protect-O Seal

• Items Available in Quantity of 100. Order with Suffix "-100"

POLYURETHANE GLADHAND SEALS

- Polyurethane Seals Will Not Crack, Tear, or Dry Out Like Rubber Seals
- Seals Remain Pliable in All Weather Conditions
- Reverse-Taper Design Prevents the Seal Lip from Folding Over
- Built-In Filter Helps Keep Out Contaminants

P/N	DESCRIPTION
441737•	Red Polyurethane Gladhand Seal
441738•	Blue Polyurethane Gladhand Seal
441739•	Black Polyurethane Gladhand Seal
GH5500	Blue Poly Gladhand Seal with Filter
GH6600	Red Poly Gladhand Seal with Filter
GH7700	Black Poly Gladhand Seal with Filter

• Items Available in Quantity of 100. Order with Suffix "-100"



GLADHAND SEAL FILTERS

Keeps Insects & Other Debris Out of Your Air Lines



P/N	DESCRIPTION
36002	Stainless Steel Filter

GLADHAND SEAL TOOL

Designed to Provide a Safe and Easier Way of Removing and Inserting Gladhand Seals.



P/N	DESCRIPTION
441823	Gladhand Seal Tool

GLADHAND SEAL COUNTERTOP DISPLAYS

- Display Rack: 12"W x 18"H - Buckets: 6"W x 5.5"H

P/N	DISPLAY	INCLUDES
441095	Stand-Up Display Rack	24 Red & Blue Polyurethane Seal 4-Packs
441095D	Stand-Up Display Rack	Display Only, No Stock
441828	Display Bucket	100 Blue Poly Seals with Built-In Filter
441829	Display Bucket	100 Red Poly Seals with Built-In Filter
441830	Display Bucket	100 Black Poly Seals with Built-In Filter
441831	Display Bucket	100 Black Rubber Seals
441832	Display Bucket	100 Red Polyurethane Seals
441833	Display Bucket	100 Blue Polyurethane Seals
441834	Display Bucket	100 Black Polyurethane Seals
441835	Display Bucket	50 Red & 50 Blue Polyurethane Seals

GLADHAND SEAL 4-PACKS

P/N	DESCRIPTION
441095P	4-Pack Red & Blue Poly Seals - 24 Refill Packs for Display 441095
441841	4-Pack Red & Blue Poly Seals with Built-In Filter



STANDARD POGO STICK

- Steel Support Arm: Choice of Chrome or Zinc & Yellow Dichromate Finish
- 41" Post Pivots at Base
- 7/16"-20 x 2.6" Mounting Stud
- Features Four Standard Gladhand Bracket & Dock Mounting Holes

FAT CAN POGO STICK

- Features a Thick Gauge Heavy Duty Spring
- Base is Over 3 Times Larger than Standard Pogos. 3.75" Dia. Housing Eliminates Spring Binding
- Chrome or Zinc-Dichromate Steel Support Arm
- 45" Swivel Arm Pivots at Base
- Forged Steel Mounting Stud: 7/16"-20
- All Fat Can Pogo Sticks Include Eyebolt and Nut



COMPARISON: Standard Pogo (Left) vs. Fat Can Pogo (Right)

P/N	DESCRIPTION
34200	Chrome Pogo Stick
34260	Zinc-Dichromate Pogo Stick
34259	Zinc-Dichromate Pogo Stick with Ring

P/N	DESCRIPTION
451057	Chrome Fat Can Pogo
451058	Chrome Fat Can Pogo with Clamp
451059	Zinc-Dichromate Fat Can Pogo
451060	Zinc-Dichromate Fat Can Pogo with Clamp

THE MAXXDUTY™ POGO STICK

OUTPERFORMS ALL OTHERS:

In Rigorous Cycle Testing, the MAXXDuty™ Pogo has Proven to Outlast Traditional Pogos by as Much as 10 Times in the Harshesht Conditions with No Signs of Wear!

EXTREMELY DURABLE:

Features UV Resistant, Injection Molded, Glass-Filled Nylon Polymer Top and Base

VERSITAL DESIGN:

The MAXXDuty™ Pogo Provides Several Attachment Options and is Perfect for Heavy Duty Line & Cable Configurations



MAXXDUTY®
HIGH PERFORMANCE PRODUCTS

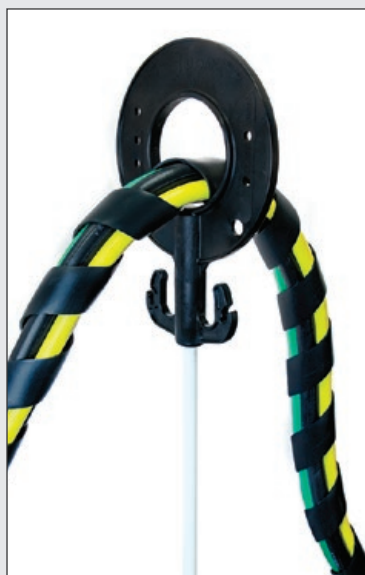

P/N	DESCRIPTION
451126	42" MAXXDuty™ Pogo
451128	22" MAXXDuty™ Pogo

POGO STICK ACCESSORIES



P/N	DESCRIPTION
34213	Clamp for 3/8" Hose with Eye Bolt
34220	Clamp for 1/2" Tube with Eye Bolt
34275	Yellow Dichromate Steel Ring with Eye Bolt
34241	Red & Blue Straps with Eye Bolt
34251	Yellow Dichromate Gladhand Bracket with Mounting Hardware
34287	Yellow Dichromate Gladhand Bracket with Mounting Hardware and Vent Hole
3420051	Yellow Dichromate Gladhand Bracket
3420087	Yellow Dichromate Gladhand Bracket with Vent Hole

GLADHAND & PLUG DOCK

- Keeps Gladhands & Electrical Plugs Stored Up Out of Dirt, Grease, and Other Contaminants
- Reduces Corrosion by Keeping Plugs Pointing Down to Prevent Moisture from Gathering
- Mount Directly to Back of Cab or on a Pogo Stick



P/N	DESCRIPTION
441747	Holds Two Gladhands & One Plug
441748	Holds Two Gladhands & Two Plugs
34211	Holds Two Gladhands & One Plug, Angled towards Driver's Side
34212	Holds Two Gladhands & One Plug, Angled towards Driver's Side, Includes Pogo Mounting Kit
34250	Pogo Mounting Kit (Hardware Only)

THE MAXXCLAMP™

Tramec Sloan's Innovative, Easy Way to Hang Your Hoses & Cables!



- Installs in Seconds! The MAXXClamp Simply Pivots Open & Closed, No Tools Required!
- No Loose Parts which Makes for Quick and Easy Installation
- Multiple Pivot Positions Provide Options for the Best Hold
- Great for 3/8" & 1/2" O.D. Air Hose, 3-in-1 and 4-in-1 Wraps, and Hydraulic Hose
- MAXXClamp Diameter Range for Hydraulic Hose is 1.25" to 1.75" O.D.



P/N	DESCRIPTION
451169	MAXXClamp for 3/8" O.D. Hose
451178	MAXXClamp for 1/2" O.D. Hose
451218	MAXXClamp for Hydraulic Hose & Wraps



1. OPEN the MAXXClamp by sliding apart the two halves.



2. PLACE your hoses/cable/wrap into the open MAXXClamp.



3. CLOSE the MAXXClamp, adding the carabiner, and it's Ready to Hang!





TENDER KITS

P/N	DESCRIPTION	LENGTH	SPRING	SLEEVE	CARABINER	INCLUDES
451087	Spring Kit	15"	x1	-	-	3-Hole Clamp
451711	Tender Kit	16"	x1	x1	x1	3-Hole Clamp
451713	Tender Kit	20"	x1	x1	x1	3-Hole Clamp
451716	Tender Kit	20"	x1	x1	x1	-
451717	Double Tender Kit	20"	x2	x2	x2	3-Hole Clamp
451718	Double Tender Kit	20"	x2	x2	x2	-
451720	Tender Kit	25"	x1	x1	x1	3-Hole Clamp
451721	Tender Kit	25"	x1	x1	x1	-
451722	Double Tender Kit	25"	x2	x2	x2	3-Hole Clamp
451723	Double Tender Kit	25"	x2	x2	x2	-
451724	Hydraulic Tender Kit	25"	x2	x2	x2	Hanger Clamp 451089
451725	Hydraulic Tender Kit	25"	x2	x2	x2	-
451750	Double Tender Kit	16"	x2	x2	x2	-
451751	Double Tender Kit	16"	x2	x2	x2	3-Hole Clamp
451752	Tender Kit	16"	x1	x1	x1	-

TENDER KITS WITH MAXXCLAMP™

P/N	DESCRIPTION	LENGTH	SPRING	SLEEVE	CARABINER	MAXXCLAMP (x1)
451738	Tender Kit	16"	x1	x1	x1	for 3/8" Hose
451739	Tender Kit	16"	x1	x1	x1	for 1/2" Hose
451740	Double Tender Kit	16"	x2	x2	x1	for 3/8" Hose
451741	Double Tender Kit	16"	x2	x2	x1	for 1/2" Hose
451742	Tender Kit	20"	x1	x1	x1	for 3/8" Hose
451743	Tender Kit	20"	x1	x1	x1	for 1/2" Hose
451744	Double Tender Kit	20"	x2	x2	x1	for 3/8" Hose
451745	Double Tender Kit	20"	x2	x2	x1	for 1/2" Hose
451746	Tender Kit	25"	x1	x1	x1	for 3/8" Hose
451747	Tender Kit	25"	x1	x1	x1	for 1/2" Hose
451748	Double Tender Kit	25"	x2	x2	x1	for 3/8" Hose
451749	Double Tender Kit	25"	x2	x2	x1	for 1/2" Hose
451755	Double Tender Kit	16"	x2	x2	x2	Wraps & Hydraulic Hose
451756	Double Tender Kit	20"	x2	x2	x2	Wraps & Hydraulic Hose
451757	Double Tender Kit	25"	x2	x2	x2	Wraps & Hydraulic Hose

TRACKER BARS & TRACKER BAR KITS



P/N	DESCRIPTION
451707	43" Tracker Bar
451708	38" Tracker Bar
451094	43" Tracker Bar with 16" Tender Kit
451095	36" Tracker Bar with 20" Tender Kit
451732	43" Slider Bar with 20" Double Tender Kit
451733	43" Slider Bar with 25" Tender Kit
451734	43" Slider Bar with 25" Double Tender Kit
451735	38" Slider Bar with 20" Double Tender Kit
451736	38" Slider Bar with 25" Tender Kit
451737	38" Slider Bar with 25" Double Tender Kit

SUPPORT SPRINGS with Clip and Hose Clamp

- Ideal for Slider Hose & Tractor/Trailer Hose Support
- 2-Hole Clamp for 3/8" Hose
- Frame Clip #451088

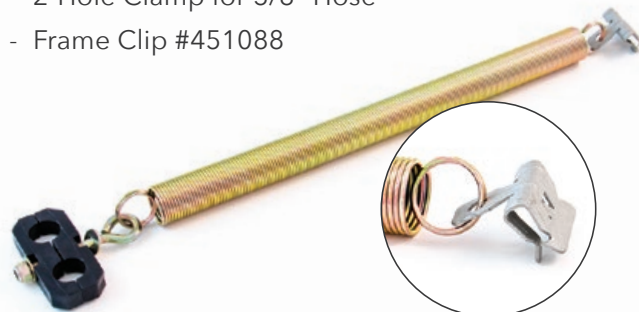

P/N	LENGTH	O.D.	WIRE
451050	13"	.75"	.0625"
451051	13"	1.00"	.080"
451052	15"	1.06"	.080"
451053*	25"	0.90"	.092"

* Spring is Galvanized

SUPPORT SPRINGS

- High-Tensile Steel Spring
- Zinc Plated, Yellow Dichromated



P/N	LENGTH	O.D.	WIRE
34015	13"	1"	.072"
34017	25"	1.0625"	.080"
451046	13"	.75"	.0625"
451047	13"	1.00"	.080"
451048	15"	1.06"	.080"
451049*	25"	0.90"	.092"
451706	15"	1.10"	.080"
451712*	20"	0.90"	.092"
451729*	16"	0.90"	.092"
6610609	9"	1.0625"	.080"

* Springs are Galvanized

SUPPORT SPRINGS with Steel Ring and Hose Clamp

- Ideal for Slider Hose & Tractor/Trailer Hose Support
- 3-Hole Clamp



P/N	LENGTH	O.D.	WIRE	CLAMP
34056	13"	1.00"	.072"	3/8" Hose
34058	13"	1.00"	.072"	1/2" Tube
34060	13"	1.00"	.072"	3/8" Hose
34061	25"	1.06"	.080"	3/8" Hose
34063	25"	1.06"	.080"	1/2" Tube
34051	Zinc-Plated 2" Steel Ring			

REPLACEMENT SLEEVES

P/N	DESCRIPTION
451726	25" Spring Sleeve
451727	20" Spring Sleeve
451728	16" Spring Sleeve

FRAME/RAIL CLIP

- A Reliable Way to Anchor Springs and Other Hardware to Frame Rail
- For 1/8" to 1/4" Flange/Plate Thickness
- 34118 Provides 500 Hours of Salt Spray Resistance
- 451069 & 451088 Provide 72 Hours of Salt Spray Resistance



P/N	DESCRIPTION
34118	Beam Flange Fastener
451069	Tender Spring Clip (5 Pack)
451088	Frame Clip (15 Pack)

HOSE HANGER ASSEMBLY

- Clamp 451001
- Frame Clip 451088



P/N	DESCRIPTION
451080	Hose Hanger Assembly

HOSE SPACERS

- Can Be Mounted by Cable Tie or Suspended by Hose Support Spring
- Made of High-Impact Nylon that is Low-Temp and UV Resistant



P/N	DESCRIPTION
451037•	Hose Spacer for 3/8" Hose
451038•	Hose Spacer for 1/2" Hose
34022	Hose Spacer for 3/8" & 1/2" Hose
34150	Hose Spacer for 1/4" & 3/8" Hose
4X663838	4-Hole Hose Spacer for 3/8" Hose
4X661212	4-Hole Hose Spacer for 1/2" Hose
4X663814	4-Hole Hose Spacer for 3/8" & 1/4" Hose

• Items Available in Quantity of 100. Order with Suffix "-100"

2-HOLE AIR HOSE CLAMPS

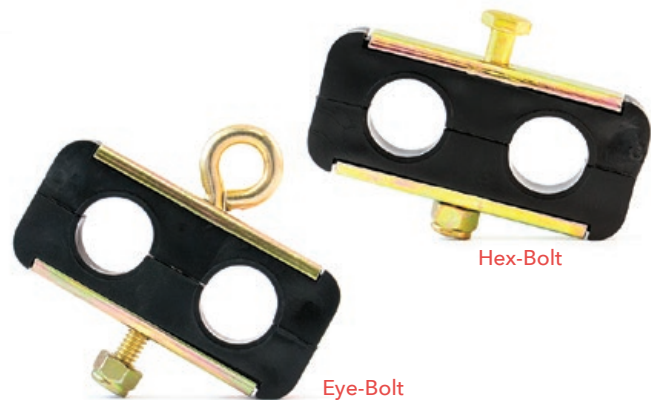

P/N	STYLE	SIZE
34268	Eye-Bolt	for 3/8" I.D. Hose
34269	Eye-Bolt	for 1/2" I.D. Hose
34160	Eye-Bolt	for 1/4" and 3/8" I.D. Hose
34270	Hex-Bolt	for 3/8" I.D. Hose
34271	Hex-Bolt	for 1/2" I.D. Hose
34161	Hex-Bolt	for 1/4" and 3/8" I.D. Hose
451001•	Eye-Bolt	for 3/8" I.D. Hose

• Hard-Molded Body



LOOKING FOR GENERAL PURPOSE HOSE CLAMPS?
Many Styles & Sizes Available on Pages 325-328

3-HOLE AIR HOSE CLAMPS

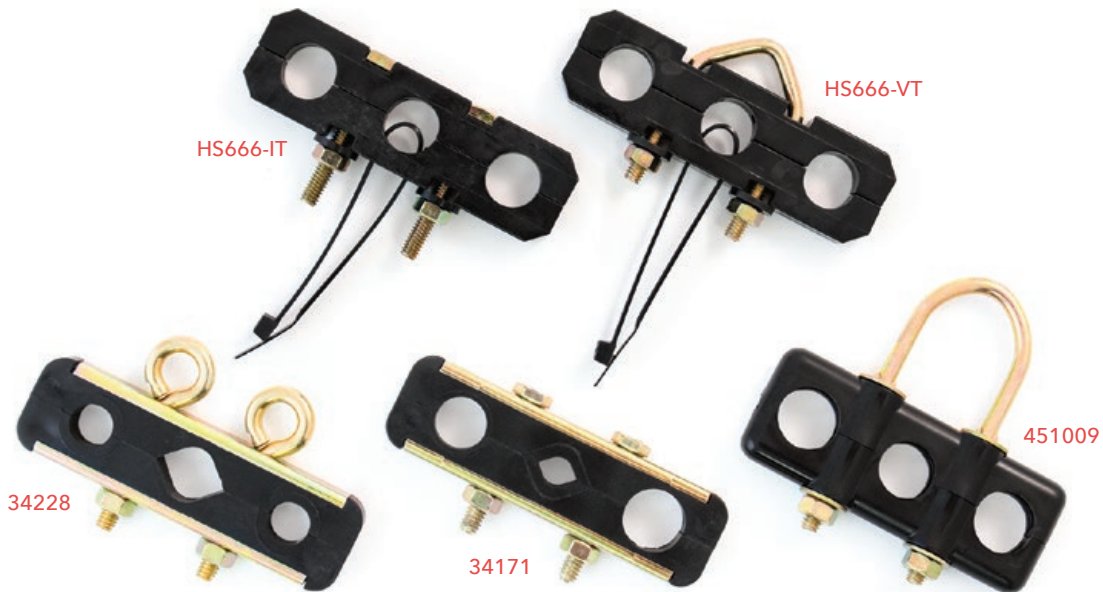

P/N	STYLE	SIZE
34229	Double Eye-Bolt	for 3/8" I.D. Hose and Cable
34228	Double Eye-Bolt	for 1/2" O.D. Tubing and Cable
34170	Double Eye-Bolt	for 1/4" and 3/8" I.D. Hose and Cable
34246	Hex-Bolt	for 3/8" I.D. Hose and Cable
34247	Hex-Bolt	for 1/2" O.D. Tubing and Cable
34171	Hex-Bolt	for 1/4" and 3/8" I.D. Hose and Cable
451009	U-Bolt	for 3/8" I.D. Hose and Cable
HS666-IT	Hex-Bolt with Tie	for 3/8" I.D. Hose and Cable
HS666-VT	V-Bolt with Tie	for 3/8" I.D. Hose and Cable

4 & 6-HOLE AIR HOSE CLAMPS



P/N	STYLE	HOLES	SIZE
3420097	Eye-Bolt	4	for 3/8" I.D. Hose
3410009	Double Eye-Bolt	6	Two for 3/8" I.D. Hose, Four for 1/4" I.D. Hose
HS6666-U	U-Bolt	4	for 3/8" I.D. Hose

"PUCK" HOSE SEPARATOR

- Separates Your Air & Electrical Lines to Prevent Chafing and Tangles
- No Tools Required!
- Keeps Your Lines Organized & Helps Prevent Kinks
- Made of Solid Rubber & Will Not Corrode
- Use Behind the Cab or Under the Trailer
- Provides a Safe Way to Inspect for Line Defects by Keeping Your Hoses and Cables Visible
- For 3/8" Hose Only
- One Puck is Recommended for Each Foot of Hose
- Standard Pack Includes 5 Pucks



P/N	DESCRIPTION
451170	Puck Hose Separator

1/4" NYLON HOSE CLAMPS



P/N	DESCRIPTION
492100	1/4" x 3/16" Nylon Hose Clamp
492101	1/4" x 1/4" Nylon Hose Clamp
492102	1/4" x 5/16" Nylon Hose Clamp
492103	1/4" x 3/8" Nylon Hose Clamp
492104	1/4" x 7/16" Nylon Hose Clamp
492105	1/4" x 1/2" Nylon Hose Clamp
492106	1/4" x 9/16" Nylon Hose Clamp
492107	1/4" x 5/8" Nylon Hose Clamp
492108	1/4" x 3/4" Nylon Hose Clamp
492109	1/4" x 7/8" Nylon Hose Clamp
492110	1/4" x 1" Nylon Hose Clamp
492111	1/4" x 1-1/8" Nylon Hose Clamp
492112	1/4" x 1-1/4" Nylon Hose Clamp
492113	1/4" x 1-3/8" Nylon Hose Clamp

1/4" RUBBER HOSE CLAMPS



P/N	DESCRIPTION
492000	1/4" x 1/4" Rubber Hose Clamp
492001	1/4" x 3/8" Rubber Hose Clamp
492002	1/4" x 1/2" Rubber Hose Clamp
492003	1/4" x 5/8" Rubber Hose Clamp
492004	1/4" x 3/4" Rubber Hose Clamp
492005	1/4" x 7/8" Rubber Hose Clamp
492006	1/4" x 1" Rubber Hose Clamp
492007	1/4" x 1-1/8" Rubber Hose Clamp
492008	1/4" x 1-1/4" Rubber Hose Clamp
492009	1/4" x 2-1/2" Rubber Hose Clamp

SLOTTED METAL CLAMPS - VINYL COATED

Slotted bottom holes and round top hole



P/N	DESCRIPTION	CLAMP	WIDTH	HOLE	SLOT
VMC316	3/16" Vinyl Coated Clamp	0.187"	5/8	0.344"	7/16
VMC14	1/4" Vinyl Coated Clamp	0.250"	1/2	0.281"	3/8
VMC516	5/16" Vinyl Coated Clamp	0.312"	1/2	0.281"	3/8
VMC38	3/8" Vinyl Coated Clamp	0.375"	1/2	0.281"	3/8
VMC12	1/2" Vinyl Coated Clamp	0.500"	1/2	0.281"	3/8
VMC58	5/8" Vinyl Coated Clamp	0.625"	1/2	0.281"	3/8
VMC34	3/4" Vinyl Coated Clamp	0.750"	1/2	0.281"	3/8
VMC78	7/8" Vinyl Coated Clamp	0.875"	1/2	0.281"	3/8
VMC100	1" Vinyl Coated Clamp	1.000"	1/2	0.281"	3/8
VMC100W	1" Vinyl Coated Clamp	1.000"	5/8	0.343"	7/16
VMC1116	1-1/16" Vinyl Coated Clamp	1.062"	1/2	0.281"	3/8
VMC114	1-1/4" Vinyl Coated Clamp	1.250"	1/2	0.281"	3/8
VMC134	1-3/4" Vinyl Coated Clamp	1.750"	1/2	0.291"	3/8

ABS SENSOR WIRE CLIPS

P/N	HOSE/TUBE	WIRE
ABS-SC-STD	1/4" Tubing	for Standard Wire
ABS-SC125	3/8" - 1/2" Hose	for Wire ~.125"
ABS-SC090	3/8" - 1/2" Hose	for Wire ~.090"
ABS-PWC	3/8" - 1/2" Hose	for Wire ~.37" - .44"

ABS-SC125



ABS-PWC



DUAL LOOP CABLE TIES

- Wraps Two Bundles with a Single Cable Tie and Provides Separation to Prevent Abrasion/Chafing
- 150lb Tensile Strength for Heavy Duty Applications
- Impact Resistant, Heat Stabilized UV Black

P/N	DESCRIPTION
422837	Dual Loop Cable Tie, 13.5", 1/4" Stud
422838	Dual Loop Cable Tie, 19.8", 1/4" Stud



AIR TANKS

FIGHTING CORROSION!

Tramec Sloan's Air Tanks have you covered, inside and out! Our American-Made Air Tanks employ a 3-Step exterior finishing process with an industry leading interior finish to help you fight corrosion.

SAE J10 requires *just 48 hours* of exterior salt spray resistance. However, Tramec Sloan air tanks go above and beyond with **500 HOURS** of salt spray resistance! Internally, our air tanks pass the same 500 hours, but also meet the stringent military spec MIL-PRF-16173 Grade 2.

When paired with a Tramec Sloan drain valve, our Air Tanks ensure years of trouble-free operation!



**MANUFACTURED
IN THE U.S.A.**



**MEETS DOT & SAE
STANDARDS**



**CORROSION
RESISTANCE**



**HIGH QUALITY
COMPONENTS**

AIR TANK - 7" DIAMETER

- 800 in³ (3.46 gallons)
- 150 PSI Working Pressure
- Threaded Ports are Standard NPT
- Meets & Exceeds all SAE J10B Specs

P/N	LENGTH	MAIN PORT	DRAIN PORT	END PORTS
461020	22"	-	-	1/2"

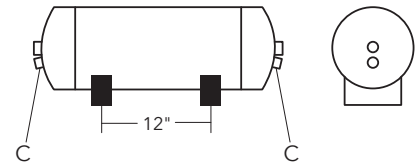

AIR TANK - 8" DIAMETER

- 1425 in³ (6.16 gallons)
- 150 PSI Working Pressure
- Threaded Ports are all Standard NPT
- Meets & Exceeds all SAE J10B Specifications

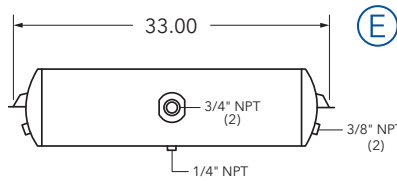
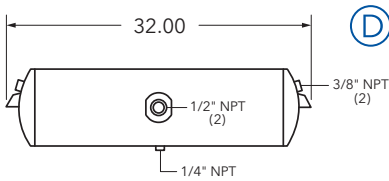
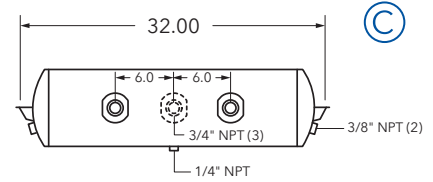
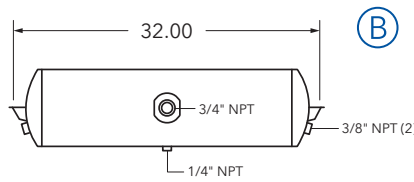
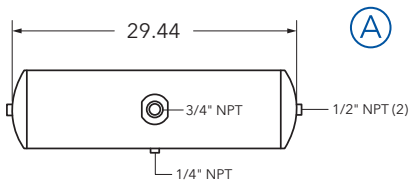

P/N	IMAGE	LENGTH	MAIN PORT(S)	DRAIN PORT	END PORT
461006	A	29.44"	3/4"	1/4"	1/2"
461007	B	32"	3/4"	1/4"	3/8"
461023	C	32"	3/4" (2)	1/4"	3/8"
461026	D	32"	1/2"	1/4"	3/8"
461027	E	33"	3/4"	1/4"	3/8"

UNIVERSAL AIR TANK

- Fits Many Truck & Trailer Makes & Models
- Simply Plug the Unrequired Ports! **
- 9.5" Diameter
- 1600 in³ (6.92 gallons) Capacity



End "A"

End "B"

P/N	LENGTH	MAIN PORTS	DRAIN PORTS	END PORTS (A)	END PORTS (B)
461045	32"	1/2" (3)	1/4" (2)	1/2" (3), 3/8" (1), 1/4" (1)	1/2" (3) and 3/8" (1)

**Plug Unrequired Ports with the Hex-Head Pipe Plugs on Page 150

AIR TANK - 9.5" DIAMETER

- 1488 in³ (6.44 gallons)
- 150 PSI Working Pressure
- Threaded Ports are all Standard NPT
- Meets & Exceeds all SAE J10B Specifications

P/N	IMAGE	LENGTH	MAIN PORT(S)	DRAIN PORT	END PORT
461001	A	27.5"	3/4"	1/4"	1/2"
461002	B	27.5"	3/4"	1/4"	3/8"
461003•	C	27.5"	3/4" (2)	1/4"	3/8"
461004	D	27.5"	1/2"	1/4"	3/8"
461005•	E	27.5"	3/4"	1/4"	3/8"
461012•	F	27.5"	1/2" (2)	1/4"	3/8"
461018	G	27.5"	3/4"	1/4"	3/8"
461019	H	27.5"	1/2" (2)	1/4"	3/8"
461025	I	27.5"	1/2" (2)	1/4"	1/2"
461029	J	27.5"	1/2" (2)	1/4"	3/8"
461032	K	27.5"	3/4" (2)	1/4"	1/2"
461033	L	27.5"	1/2" (2)	1/4"	3/8"
461034	M	27.5"	3/4" & 1/2"	1/4"	3/8"
461037	N	27.5"	3/4" (3)	1/4"	3/8"
461040	O	27.5"	1/2" (2)	1/4"	1/2"

• Items Available in Quantity of 22. Order with Suffix "-22"

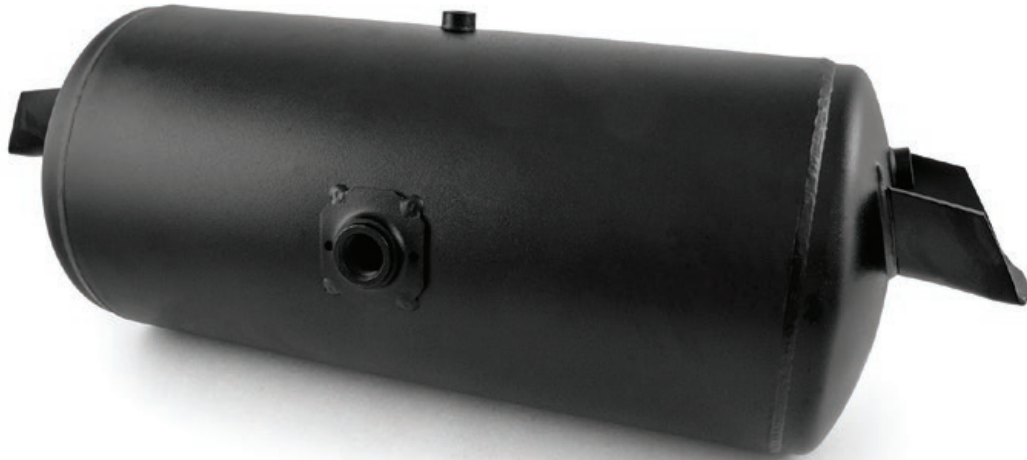

TS TECH TIP:

Having and maintaining a clean air brake system is crucial to the safety of the overall vehicle. Failure to do so can lead to corrosion of essential valves and failure to the air brake system. Simple steps such as **using filters** in gladhand applications and **draining your air tanks daily** helps keep the system clean, corrosion free, and working properly.

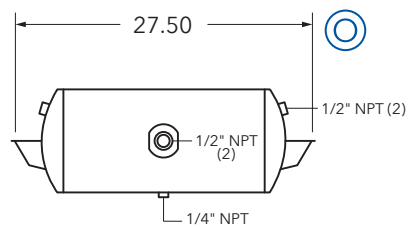
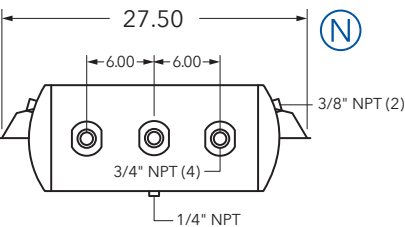
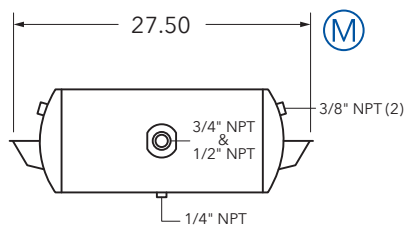
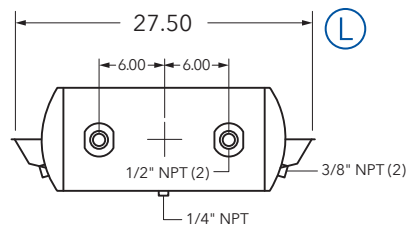
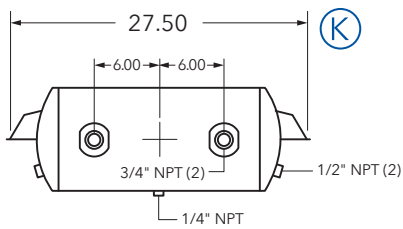
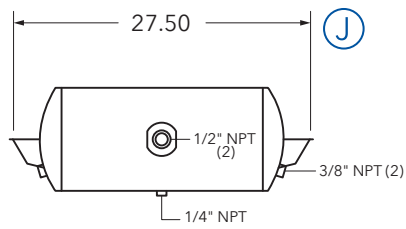
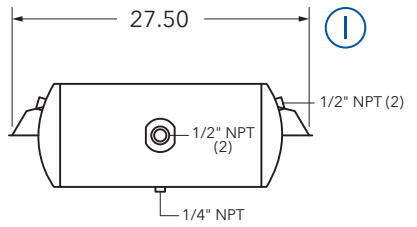
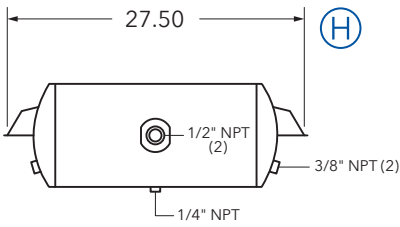
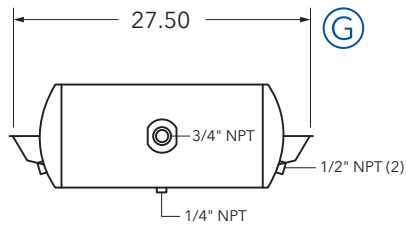
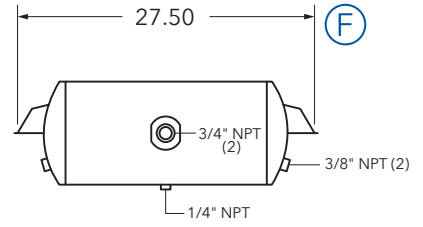
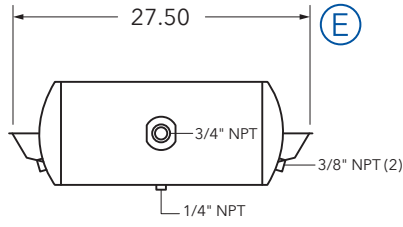
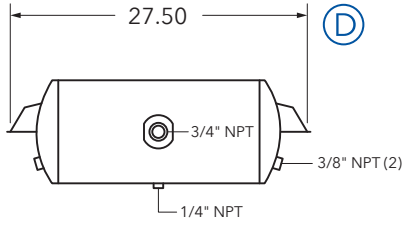
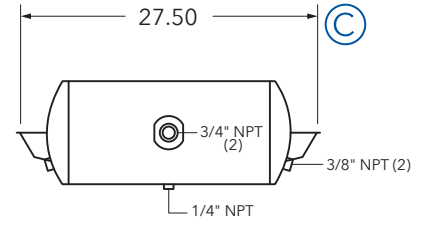
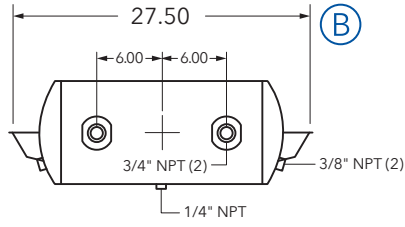
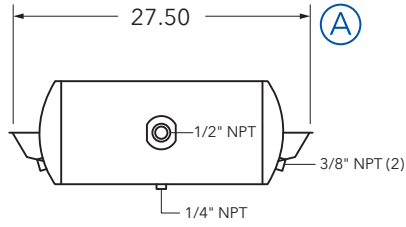

AIR TANK - 12" DIAMETER

- 150 PSI Working Pressure
- Threaded Ports are all Standard NPT
- Meets & Exceeds all SAE J10B Specifications

• 461009 is Available in Quantity of 18. Order with Suffix "-18"

* 461036 is a Dual Air Tank

P/N	IMAGE	CAPACITY	LENGTH	MAIN PORT(S)	DRAIN PORT	END PORT
461008	A	2850 in ³ (12.34 Gal)	29.5"	3/4"	1/4"	3/8"
461009•	B	2850 in ³ (12.34 Gal)	29.5"	3/4" (2)	1/4"	3/8"
461010	C	2850 in ³ (12.34 Gal)	29.5"	3/4"	1/4"	3/8"
461016	D	2850 in ³ (12.34 Gal)	29.5"	3/4"	1/4"	3/8"
461017	E	2850 in ³ (12.34 Gal)	29.5"	3/4" & 1/2"	1/4"	3/8"
461022	F	2850 in ³ (12.34 Gal)	29.5"	3/4" (3)	1/4"	3/8"
461024	G	2850 in ³ (12.34 Gal)	29.5"	1/2"	1/4"	3/8"
461035	H	2850 in ³ (12.34 Gal)	29.5"	3/4" & 1/2"	1/4"	3/8"
461036*	I	4400 in ³ (19.05 Gal)	31.50"	1/2" (3)	1/4"	1/2"
461039	J	4400 in ³ (19.05 Gal)	43.375"	3/4" (2)	1/4"	3/8"
461046	K	2850 in ³ (12.34 Gal)	29.5"	3/4" (3)	1/4"	3/8"

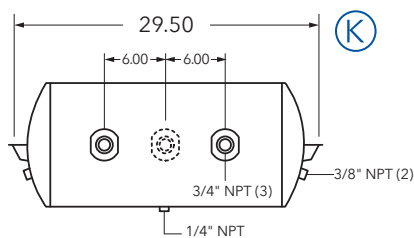
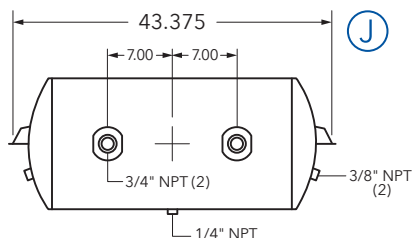
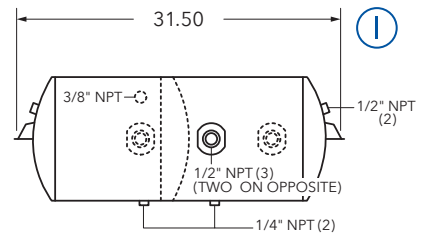
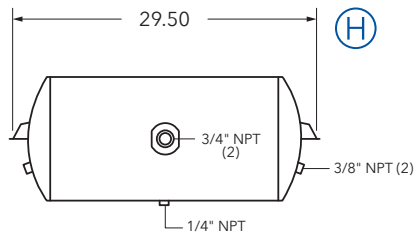
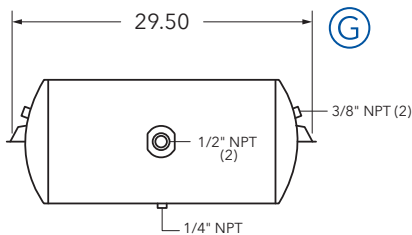
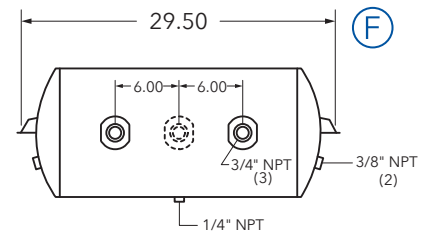
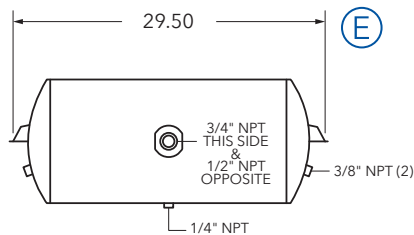
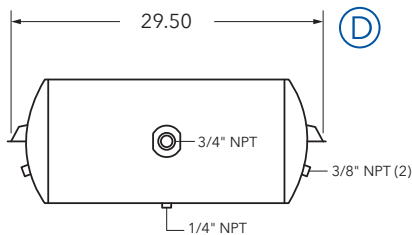
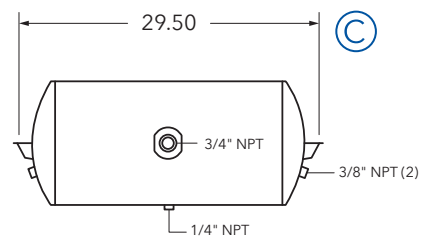
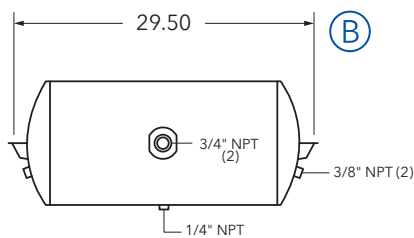
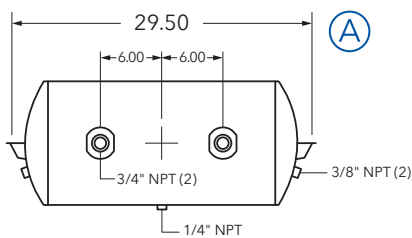

RUBBER MOUNTING PAD

For All Bracket-Mounted Air Tanks

P/N	DESCRIPTION
461011	Rubber Mounting Pad



LOW PROFILE DRAIN VALVES

- Corrosion Resistant Brass Valve Bodies with Stainless Steel Spring
- Nylon-Coated Steel Cable is Certified to 200lbs Pull-Test
- Low-Profile to Minimize Accidental Hits & Damages
- Pipe Thread: 1/4" NPTF
- For Pre-Coated Pipe Threads, Add the Prefix "P" to the Part Number

P/N	DESCRIPTION
35000	Low-Profile Drain Valve
35002-048	Low-Profile Drain Valve with 48" Cable
35002-060	Low-Profile Drain Valve with 60" Cable
35006-048	Low-Profile Drain Valve with 48" Heavy Duty Cable
35006-060	Low-Profile Drain Valve with 60" Heavy Duty Cable
35013	Low-Profile Drain Valve with Unclinched Cable & Aluminum Clip
35001-064	Cable for Low-Profile Drain Valve
35008	Aluminum Clip for Low-Profile Drain Valve



STANDARD DRAIN VALVES

- Corrosion Resistant Brass Valve Bodies with Stainless Steel Spring
- Nylon-Coated Steel Cable is Certified to 200lbs Pull-Test
- Pipe Thread: 1/4" NPTF
- For Pre-Coated Pipe Threads, Add the Prefix "P" to the Part Number

P/N	DESCRIPTION
35007	Standard Drain Valve
35007-048	Standard Drain Valve with 48" Cable
35007-060	Standard Drain Valve with 60" Cable
35007U060	Standard Drain Valve with Unclinched Cable and Aluminum Clip
C8016	Cable for Standard Drain Valve
35017	Aluminum Clip for Standard Drain Valve



DRAIN VALVES

SHORT-BODY PRESSURE RELIEF VALVES

- Corrosion Resistant Brass Valve Bodies with Stainless Steel Spring
- Low-Profile Air Tank Installation
- For Pre-Coated Pipe Threads, Add the Prefix "P" to the Part Number



P/N	DESCRIPTION
35901	1/4" NPTF Short-Body Valve
35903	3/8" NPTF Short-Body Valve
35909	1/2" NPTF Short-Body Valve
401315	M-22 Thread Short-Body Valve

LONG-BODY PRESSURE RELIEF VALVES

- Corrosion Resistant Brass Valve Bodies with Stainless Steel Spring
- Shallow Tee Installation
- For Pre-Coated Pipe Threads, Add the Prefix "P" to the Part Number



P/N	DESCRIPTION
35905	1/4" NPTF Long-Body Valve
35907	3/8" NPTF Long-Body Valve

AUTOMATIC DRAIN VALVES



401216



401270

P/N	DESCRIPTION	INLET	OUTLET
401216	DV-2 Automatic Drain Valve	1/4"	1/4"
401270	Automatic Heated Drain Valve (12 Volt, 5 Amp)	1/4"	1/4"

EXTENSIVE VALVE SELECTION

Whether Through Our Own Design & U.S. Manufacturing or Through Reliable Sourcing, Tramec Sloan has Your Air Valve Needs Covered.

- Dash Control Valves: Page 90
- Transmission Air Shift Valves: Page 94

- Air Brake Valves: Page 95
- Air Accessory Valves: Page 109



MANUFACTURED
IN THE U.S.A.



MEETS DOT & SAE
STANDARDS



CORROSION
RESISTANCE



HIGH QUALITY
COMPONENTS

PP-1 STYLE CONTROL VALVE WITH KNOB

- Commonly Used to Control Parking and Emergency Brakes
- All Ports 1/8" PT
- Stem Diameter: .377"



P/N	DESCRIPTION
401134	PP-1 Style Control Valve, 20 PSI Automatic Pressure Release
401135	PP-1 Style Control Valve, 40 PSI Automatic Pressure Release

PP-5 STYLE CONTROL VALVE

- Used in Conjunction with Vehicle Torque Converter, Engine Speed Control System, and Some Parking Brake Systems
- 40 PSI Release Pressure
- All Ports 1/8" PT

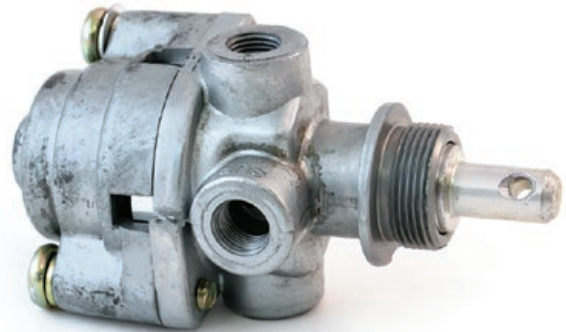

P/N	DESCRIPTION
401180	PP-5 Style Control Valve

PP-7 STYLE CONTROL VALVE

- Generally Used on Tractors and Provides Modulated Control on Trailer Brakes
- 40 PSI Release Pressure

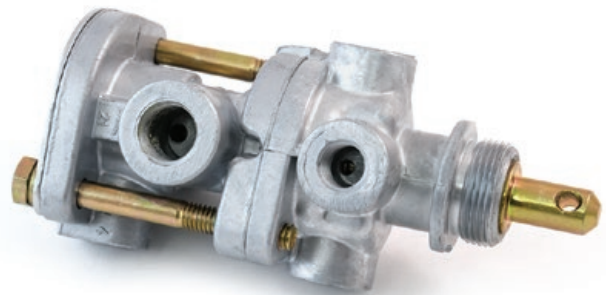

P/N	DESCRIPTION	STEM DIA.	SUPPLY	DELIVERY	CONTROL	EXHAUST
401136	PP-7 Style Control Valve	.377"	1/8" PT	1/4" PT	1/8" PT	-
401137	PP-7 Style Control Valve	.50"	1/8" PT	1/4" PT	1/8" PT	1/4" NPTF

PP-8 PUSH/PULL VALVE

- 20 PSI Release Pressure
- All Ports 1/8" PT



P/N	DESCRIPTION
401209	PP-8 Push/Pull Valve

BRASS DASH CONTROL VALVES

- Precision Engineered & Manufactured to Provide Optimum Performance for Each Specified Application
- New Construction, Not Remanufactured

- Tramec Sloan's All-Brass Valves Provide Years of Dependable, Trouble-Free Operation
- Supplied with Mounting Nut



TRACTOR/TRAILER PARK VALVE *with 2-Way Check Valve*

- 2-Way Check Valve Allows Either Primary or Secondary Air Supply to Operate Spring Brakes on Tractor and/or Trailer Combinations
- All Ports 1/4"-18 NPTF
- Stem Diameter: .377"



P/N	DESCRIPTION
401029	Tractor/Trailer Park Valve
401084	Tractor/Trailer Park Valve with Barbed Fitting Exhaust Port for 1/2" Nylon Tubing

TRACTOR/TRAILER AIR SUPPLY VALVE

- Valve is Used to Control the Tractor Protection Valve and the Charge Trailer System
- Pull to Exhaust; Push to Supply
- All Ports 1/4"-18 NPTF
- Stem Diameter: .314"



P/N	DESCRIPTION
401032	Tractor/Trailer Air Supply Valve

SYSTEM PARK VALVE

- Valve is Used to Control Spring Brakes on Both Tractor and Trailer
- Automatically Applies when Pressure Drops Below 35 PSI
- Pull to Exhaust; Push to Supply
- All Ports 1/4"-18 NPTF
- Stem Diameter: .377"



P/N	DESCRIPTION
401035	System Park Valve

DASH CONTROL & SHIFT VALVES

DASH CONTROL VALVE REPAIR KIT

P/N	DESCRIPTION
401039	Dash Control Valve Repair Kit

- Repairs Tramec Sloan Brass Dash Control Valves: 401029, 401032, 401035, and 401084
- Not Intended for PP-1 & PP-7 Bendix Style Valves
- Includes O-Ring, Washer, Seals, Nut & Instructions

TOGGLE TYPE VALVE

- Used to Control the Tractor Protection Valve, Front Wheel Brake Limiting Control and for Inter-Axle Differential Lock-Out Control
- Features a Chrome-Plated Lever
- All Ports 1/8"-27 NPTF
- Does Not Include Face Plate 401705
- Replaces Bendix TW-1

P/N	DESCRIPTION
401040	Toggle-Type Valve, Brass Body
401813	Toggle-Type Valve, Aluminum Body

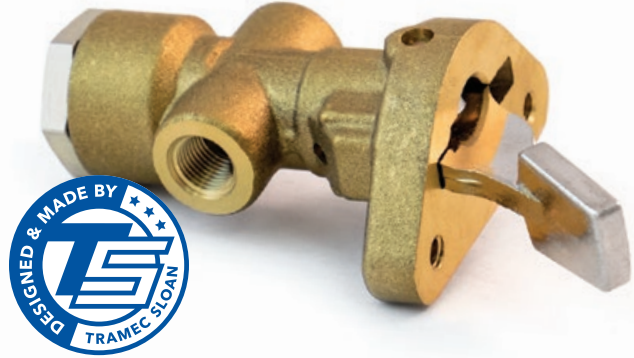

MV-2 DASH VALVE

- One-Piece Construction
- 1/4" Unthreaded Mounting Holes

P/N	DESCRIPTION
401232	MV-2 Dash Valve



MV-3 DASH VALVES

- Combo PP1 & PP7
- Recessed Plate is Type 1, Flat Plate is Type 2
- 4 Mounting Holes



P/N	DESCRIPTION	BENDIX STYLE
401233	MV-3 Dash Valve	-
401819	MV-3 Dash Control Valve with PTC	802122
401823	Recessed Plate, 1/4" Ports, .275" Mounting Holes. International Application	065157, 800516
401824	Flat Plate, 1/4"-20 Mounting Holes. Volvo & Western Star Applications	065186, 800519
401825	Recessed Plate, 1/4" Ports, 1/4" Unthreaded Mounting Holes. 1/8" NPT AUX Port. International Application	065160, 800518
401826	Flat Plate, M6 x 1-6H Threaded Mounting Holes, AUX Port. Multiple Mack Applications	065208, 800522
401827	Flat Plate, 10-24 Threaded Mounting Holes. Peterbilt Applications	065248, 800523
401828	Flat Plate, 1/4"-20 Threaded Mounting Holes, PTC Ports. Multiple Freightliner Apps	800036, 800259
401829	Recessed Plate, 1/4"-20 Threaded Mounting Holes, 1/4" NPT Ports, Multiple Freightliner & International Applications	065187, 800573
401830	Flat Plate, M6 X 1-6H Threaded Mounting Holes, Multiple Mack Applications	800515
401831	Recessed Plate, .275" Type Mtg Holes, PTC Ports. Multiple Peterbilt & International Apps	800257, 065523, 1010518, 5002691
401832	Recessed Plate, .275" Type Mtg Holes, PTC Ports. Multiple Peterbilt & International Apps	802122
401833	Recessed Plate, M6 x 1-6H Mounting Holes, PTC Ports. Multiple Mack & Volvo Apps	800840

DASH CONTROL VALVES

- Fits Standard 22mm x 44mm Openings
- DOT-Approved Push-to-Connect Fittings Included
- Maximum Pressure: 150 PSI
- Operating Temperature: -10°F to +160°F

P/N	DESCRIPTION
401244	Inter-Axle Differential Lock
401245	Fifth Wheel Slide
401246	Air Suspension Dump
401247	Power Take-Off
401248	Air Intake
401250	Universal



DASH CONTROL VALVE KNOBS

- Includes Roll Pin for Mounting



P/N	DESCRIPTION	COLOR	HOLE DIA.	APPLICATION
401705	Two-Speed Axle Face Plate	Silver	.22" (x2)	401040
401708	Trailer Air Supply	Red	.316"	401032, 401137
401710	System Park	Yellow	.379"	401029, 401035, 401084, 401134, 401135, 401136
401712	Tractor Park	Blue	.310"	401032, 401137
401714	Parking Brake	Yellow	.376"	401029, 401035, 401084, 401134, 401135, 401136
401716	Trailer Emergency	Red	.320"	401032, 401137
401725	7/8" Jam Nut	-	-	All TS Dash Valves
401727	Parking Brake	Yellow	1/4"-18 Female	-

DASH CONTROL & SHIFT VALVES

TRANSMISSION SELECTOR VALVES



P/N	DESCRIPTION	PORT	REPLACES
401289	Transmission Selector Valve	1/16"	Eaton/Fuller A4487
401290	Transmission Selector Valve	1/16"	Eaton/Fuller A4490
401291	Transmission Selector Valve	1/16"	Eaton/Fuller A4491

TRANSMISSION VALVE

Replaces Eaton/Fuller A3546



AIR SHIFT VALVE

Replaces Eaton/Fuller A4041



P/N	DESCRIPTION
401292	Transmission Valve - 1/8" Ports

P/N	DESCRIPTION
401293	Air Shift Valve - 1/4" Ports

ERGONOMIC TRANSMISSION AIR SHIFT VALVES



P/N	DESCRIPTION	PORT	REPLACES
401297	Ergonomic Transmission Air Shift Valve	1/16"	Eaton/Fuller A6913, A4900
401299	Ergonomic Transmission Air Shift Valve	1/16"	Eaton/Fuller A6909, A5010
401301	Ergonomic Transmission Air Shift Valve	1/16"	Eaton/Fuller A6915, A5015
401303	Ergonomic Transmission Air Shift Valve	1/16"	Eaton/Fuller A6918

CHECK VALVES

- Precision Engineered & Manufactured to Provide Optimum Performance
- All-Brass Valves Provide Years of Dependable, Trouble-Free Operation



ONE-WAY CHECK VALVE

P/N	DESCRIPTION	FEMALE THREAD	MALE THREAD
401008	One-Way Check Valve	3/8"-18 NPTF	3/8"-18 NPTF
401009	One-Way Check Valve	1/2"-14 NPTF	1/2"-14 NPTF



LOW-PROFILE ONE-WAY CHECK VALVE

P/N	DESCRIPTION	FEMALE THREAD	MALE THREAD
401012	Low-Profile One-Way Check Valve	3/8"-18 NPTF	3/4"-14 NPTF



90° ONE-WAY CHECK VALVE

With Thread Sealant

P/N	DESCRIPTION	FEMALE THREAD	MALE THREAD
401017	90° One-Way Check Valve	1/2"-14 PTF	1/2"-14 PTF



Z-TYPE ONE-WAY CHECK VALVE

With Thread Sealant

P/N	DESCRIPTION	FEMALE THREAD	MALE THREAD
401018	Z-Type One-Way Check Valve	1/2"-14 NPTF	1/2"-14 NPTF



TWO-WAY CHECK VALVE

Anodized Aluminum Finish for Corrosion Resistance

P/N	A	B	C	D
401019	3/8-18 NPTF	1/2"-14 NPTF	3/8"-18 NPTF	3/8"-18 NPSF
401171	3/8-18 NPTF	3/8"-18 NPSF	-	3/8"-18 NPSF

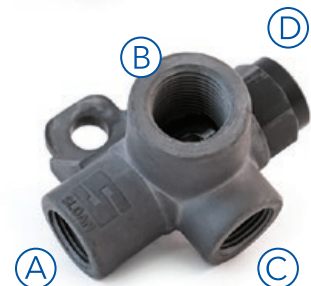

PROTECT YOUR AIR BRAKE SYSTEM!

Pressure Protection Valves are Used to Isolate Auxiliary Air Systems from the Brake System. They are Designed to Preserve Air for Braking in the Event the Auxiliary System Develops a Leak.

- Assembled & Individually Tested in the USA!
- Hard Anodized Finish for Superior Corrosion Resistance
- Features an Internal Check Valve
- Includes an Integrated Filter
- Same Heavy Duty Seals as the TEV
- Two 3/8"-18 NPTF Ports
- Aluminum Die-Cast Body
- Choice of Two Pressure Settings
- Brass Internal Components



P/N	DESCRIPTION	INLET PORT	OUTLET PORT	NOM. CLOSING PRESSURE
51350	Pressure Protection Valve	3/8"-18 NPTF	3/8"-18 NPTF	70 PSI
51351	Pressure Protection Valve	3/8"-18 NPTF	3/8"-18 NPTF	60 PSI

PR-2 STYLE PRESSURE PROTECTION VALVE

- Replaces BENDIX PR-2
- Opening PSI is 15-20 PSI Higher than Closing PSI
- To Adjust Closing PSI: Loosen Nut and Turn Knob

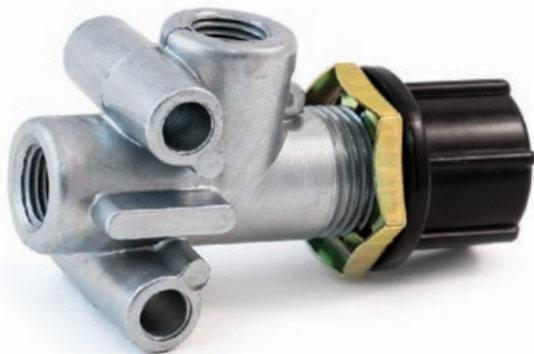

P/N	SUPPLY	DELIVERY	CLOSING PSI
401286	1/4"	1/4"	65

PR-4 STYLE PRESSURE PROTECTION VALVE

- Replaces BENDIX PR-4
- Opening PSI is 10 PSI Higher than Closing PSI



P/N	SUPPLY	DELIVERY	CLOSING PSI
401181	1/4"	1/4"	85

ST-3 STYLE SAFETY VALVE

- Protects the Air Brake System Against Excessive Air Pressure Build-Up
- 150 PSI Cracking Pressure



P/N	DESCRIPTION
401206	ST-3 Style Safety Valve

PRESSURE PROTECTION VALVE

- Normally Closed
- Opening PSI: 60-80 PSI
- Closing PSI: 46 PSI



P/N	PORTS	MAX PSI
401207	1/4"	150

TP-3 STYLE TRACTOR PROTECTION VALVE

- Trailer Service & Emergency Ports: 1/2"
- Tractor Service Port: 3/8"
- Tractor Emergency Port: 1/4"



P/N	DESCRIPTION
401228	TP-3 Style Tractor Protection Valve

INLINE PRESSURE PROTECTION VALVE

- Designed to Isolate Vehicle Air Systems in Case of Leakage
- Protects the Integrity of the Air Supply
- 75 PSI Open, 60 PSI Close
- 1/4" Tube O.D.



P/N	DESCRIPTION
401818	Inline Pressure Protection Valve

PRESSURE PROTECTION VALVES

- Protects Primary Air Source Against Loss of Air Pressure Downstream
- Designed for In-Tank Mounting on Tanks with Dual Outlet Ports



P/N	INLET PORTS	OUTLET PORTS	NOM. OPENING PRESSURE	NOM. CLOSING PRESSURE	CAP COLOR
401152	3/8 NPTM	3/8 NPTF	55 PSI	45 PSI	Black
401153	3/8 NPTM	3/8 NPTF	85 PSI	67 PSI	Red
401154	1/2 NPTM	3/8 NPTF	55 PSI	45 PSI	Black
401155	1/2 NPTM	3/8 NPTF	85 PSI	67 PSI	Red
401156	1/2 NPTM	1/4 NPTF*	100 (Max) PSI	70 (Min) PSI	Red

* One Outlet Port is Plugged

AIR BRAKE VALVES

QUICK RELEASE VALVES

- Designed to Reduce Brake Lag in the Air Brake System
- For Service Applications
- Anodized Aluminum Die-Cast Body for Superior Corrosion Resistance
- Crack Pressure: 0-0.5 PSI



P/N	SUPPLY	DELIVERY
51100	3/8"	1/4" x 1/4"
51101	1/2"	1/4" x 1/4"
51102	1/2"	3/8" x 3/8"
51103	3/8"	3/8" x 3/8"
51104	1/4"	1/4" x 1/4"
51110	Repair Kit (O-Ring & Diaphragm)	

LQ-4 STYLE FRONT AXLE QUICK RELEASE VALVE

60 PSI Equalizing Pressure

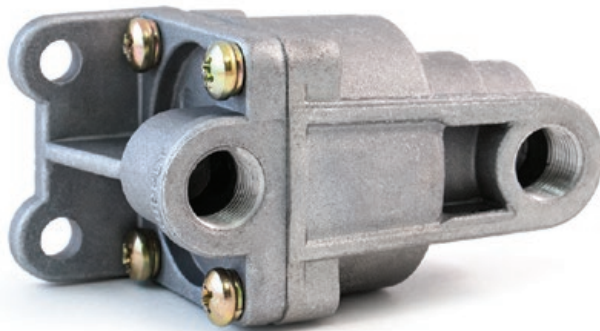

P/N	SUPPLY	DELIVERY
401212	3/8"	3/8"

QUICK RELEASE VALVES FOR AIR RIDE AXLES

- With Extended Life Diaphragm for the Heavy Duty Needs of Air Ride Axles (Yellow Cover)
- For Constant Pressure Applications
- Anodized Aluminum Die-Cast Body for Superior Corrosion Resistance
- Crack Pressure: 0-0.5 PSI



P/N	SUPPLY	DELIVERY
51142	1/2"	3/8" x 3/8"
51143	3/8"	3/8" x 3/8"
51140	Repair Kit (O-Ring & Air Ride Diaphragm)	

QR-1C STYLE QUICK RELEASE VALVE

- Replaces Bendix QR-1C Quick Release Valve
- Used Wherever a Quick Release Function is Required in the Air Brake System
- Aids in Meeting FMVSS-121 Timing Requirements
- Includes a 1/4" Balance Port

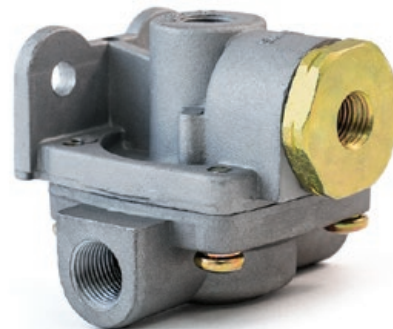

P/N	SUPPLY	DELIVERY
401279	1/4"	3/8"

QR-1 STYLE QUICK RELEASE VALVES

- Replaces Bendix QR-1 Quick Release Valve
- Aids in Meeting FMVSS-121 Timing Requirements
- Used Wherever a Quick Release Function is Required in the Air Brake System



P/N	SUPPLY	DELIVERY	EXHAUST	CRACK PRESSURE
401143	3/8"	3/8" (x2)	3/8"	1.0 PSI
401144	1/2"	3/8" (x2)	3/8"	1.0 PSI
401280	3/8"	1/4"	3/8" (No Thread)	1.0 PSI
51106	1/2"	3/8" (x2)	1/2"	0.0 PSI
51107	3/8"	3/8" (x2)	1/2"	0.0 PSI

INLINE QUICK RELEASE VALVES

- Rapidly Releases Air Pressure from the Trailer Brake Lines
- Faster Release of Trailer Service Brakes when Installed on Service Side Gladhand
- Quicker Application of Trailer Service Brakes when Installed on the Emergency Side Gladhand
- Can be Used on Double and Triple Trailers
- Measures 1.5" Diameter x 3.5" Long
- Flow Rate: Forward - 9.0 SCFM at 2 PSI
Exhaust - 8.0 SCFM at 2 PSI



P/N	DESCRIPTION	TRACTOR	TRAILER
401145	Mounts Between Tractor Protection Valve & Air Lines	1/2"-14 FPT	1/2"-14 MPT
401146	Mounts at Tractor Gladhand	1/2"-14 FPT	1/2"-14 MPT

D-2 STYLE AIR GOVERNOR

Working in Conjunction with the Compressor Unloader Valve, the Governor Controls Air Pressure in the Supply System Automatically by Maintaining the Level of Air Between the Adjustable Opening and Closing Preset Pressure Settings.

- Replaces Bendix D2, Midland KN18530 and Other Popular Air Governors
- Can be Remote or Compressor Mounted
- Manually Adjustable Opening & Closing Settings: Turn Screw Under Cap Counter-Clockwise to Raise the Cut PSI. Turn Clockwise to Lower Cut PSI. (Range is preset and not adjustable)
- Internal Ball Check and Filtered Ports Help Reduce Contamination
- 150 PSI Maximum Operating Pressure
- Includes Mounting Gasket and Four 1/8" Socket Head Pipe Plugs
- Mounting Holes on 1-1/8" Centers
- 401237 is a High Temperature Governor with High Temp O-Rings and Waterproof Cover

• Item Available in Quantity of 25. Order with Suffix "-25"



P/N	DESCRIPTION	PORTS	CUT-IN PRESSURE	CUT-OUT PRESSURE
401142•	D-2 Style Air Governor	1/8" NPT	90-105	125 ± 5
401237	High Temp D-2 Style Air Governor	1/8" PT	90-105	125 ± 5
401822	D-2 Style Governor and Check Valve Kit for AD-IS Air Dryers			

E-3 STYLE FOOT VALVE



P/N	SUPPLY	DELIVERY	AUX
401213	1/2" (x2)	1/2" (x4)	1/4" (x2)

E-8 STYLE FOOT VALVE

- Replaces Bendix E-8P Foot Valve
- Lower Body Rated



P/N	SUPPLY	DELIVERY	AUX
401275	3/8" (x2)	3/8" (x4)	3/8"

SR-1 STYLE SPRING BRAKE VALVE

- Back Mounted
- 90-95 PSI Limiting Pressure



P/N	SUPPLY	DELIVERY	EXHAUST	RESERVOIR
401211	1/4"	1/4"	1/4"	1/4"

E-6 STYLE DUAL BRAKE VALVE

- Replaces Bendix E-6 Dual Brake Valve
- Meets FMVSS-121 Requirements



P/N	SUPPLY 1	SUPPLY 2	DELIVERY 1	DELIVERY 2
401133	3/8" (x2)	3/8" (x2)	3/8" (x2)	3/8" (x2)

RE-6 STYLE RELAY VALVE

- Replaces Bendix RE-6 Relay Valve
- 4 Port Delivery
- Dual Function Valve Used on Trailers
- Used on Pre-FMVSS-121 Vehicles and Off-Road Applications

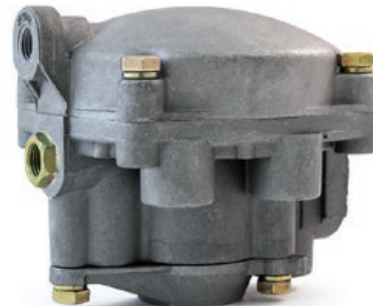

P/N	SUPPLY	DELIVERY	SERVICE	INTERNAL EMERGENCY APPLICATION PRESSURE	MAX EMERGENCY RELEASE PRESSURE
401130	3/8" PT	3/8" (x2) & 1/4" (x2) PT	1/4" PT	5 ± 5 PSI	95 PSI

R-6 STYLE RELAY VALVE

- Replaces Bendix R-6 Relay Valve
- 4 Port Delivery
- 180° Service Port



P/N	SUPPLY	DELIVERY	CONTROL	CRACK PRESSURE
401131	3/8" PT	3/8" PT (x4)	1/4" PT	2.0 PSI

AIR BRAKE VALVES

R-8 STYLE RELAY VALVE



P/N	SUPPLY	DELIVERY	SERVICE
401210	3/4" (x2)	1/2" (x2)	1/4"

RELAY VALVE

4-5 PSI Cracking Pressure

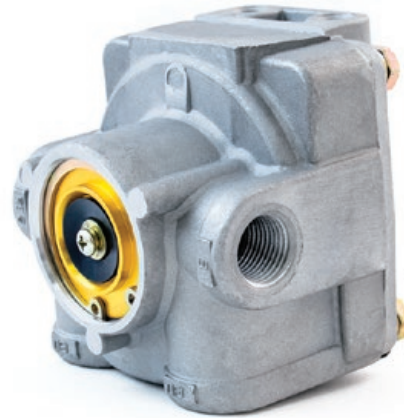

P/N	SUPPLY	DELIVERY	CONTROL
401220	1/2" (x2)	3/8" (x2)	3/8"

R-12 STYLE RELAY VALVE

- Replaces Bendix 102626 R-12 Relay Valve
- Vertical Mount
- 4 Port Delivery Located on the Bottom of the Valve
- Includes Universal Mounting Bracket



P/N	SUPPLY	DELIVERY	CONTROL	CRACK PRESSURE
401132	1/2" PT	1/2" PT (x4)	1/4" PT	4.0 PSI

R-12 STYLE RELAY VALVE

- Replaces Bendix 065303 Relay Valve
- Vertical Mount
- 2 Port Delivery Located on the Side of the Valve

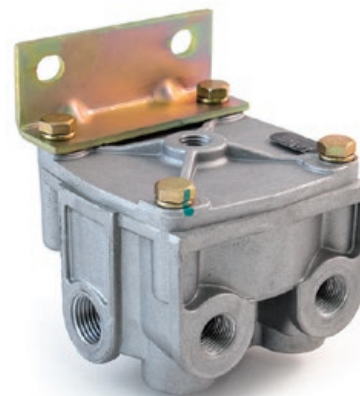

P/N	SUPPLY	DELIVERY	CONTROL	CRACK PRESSURE
401274	1/2" PT (x2)	3/8" PT (x2)	1/4" PT	4.0 PSI
401820	3/8" PT (x2)	3/8" PT (x2)	1/4" PT	5.5 PSI

R-12 STYLE RELAY VALVE

- Replaces Bendix 800238 Relay Valve
- 2 Port Delivery Located on the Side of the Valve
- 4.0 PSI Crack Pressure
- Horizontal Mount



P/N	SUPPLY	DELIVERY	CONTROL
401168	3/4" PT (x2)	1/2" PT (x2)	1/4" PT

R-12P STYLE RELAY VALVE

- Replaces Bendix 109264X Relay Valve
- 0 PSI Crack Pressure



P/N	SUPPLY	DELIVERY	CONTROL
401821	3/8" PT (x2)	3/8" PT (x2)	1/4" PT

R-14H STYLE RELAY VALVE

- Replaces Bendix R-14H Relay Valve
- Horizontal Mount
- 2 Port Delivery
- Controls Spring Brakes and Service Brakes
- 1/8" Balance Port Located Under Exhaust Cover

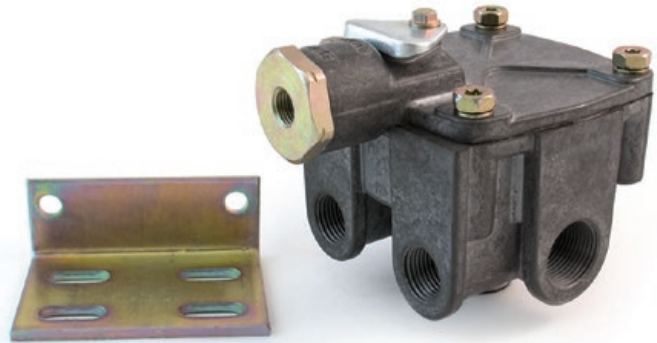

P/N	SUPPLY	DELIVERY	CONTROL	CRACK PRESSURE
401169	3/4" PT (x2)	1/2" PT (x2)	1/4" PT	4.0 PSI

R-14 STYLE RELAY VALVE

- Replaces Bendix R-14 Relay Valve
- Vertical Mount
- 4 Port Delivery
- Controls Spring Brakes and Service Brakes
- Includes Universal Mounting Bracket

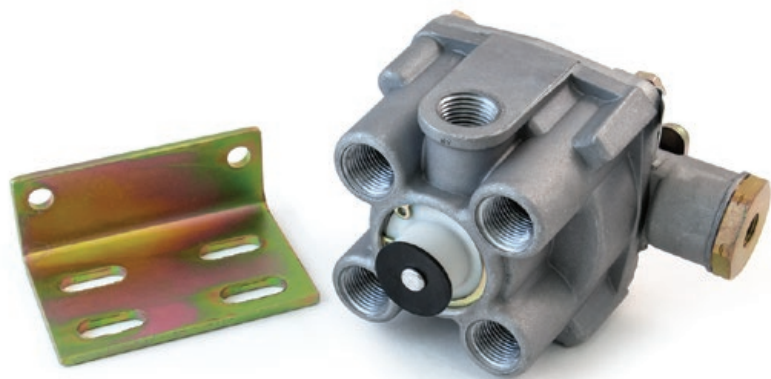

P/N	SUPPLY	DELIVERY	CONTROL	CRACK PRESSURE
401170	1/2" PT	1/2" PT (x4)	1/4" PT	4.0 PSI

RG2 STYLE RELAY VALVES

- Replaces Midland RG2 Relay Valve
- Used to Apply and Release Service Brakes on Tractor or Trailer
- 2 Port Delivery

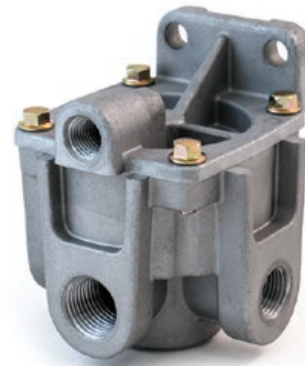

P/N	SUPPLY	DELIVERY	CONTROL	CRACK PRESSURE
401201	3/8" PT (x2)	3/8" PT (x2)	1/4" PT	5.5 PSI
401202	1/2" & 3/8" PT	3/8" PT (x2)	1/4" PT	5.5 PSI
401182	1/2" PT (x2)	1/2" PT (x2)	1/4" PT	5.5 PSI

RELAY EMERGENCY VALVE



P/N	SUPPLY	DELIVERY	CONTROL	EMERGENCY SUPPLY
401226	1/2"	1/4" (x4)	1/4" (x2)	1/4"

RELAY EMERGENCY VALVE

Charging Type

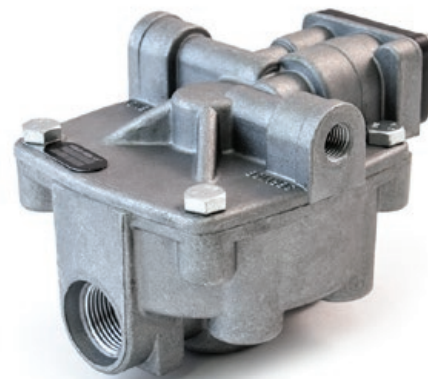

P/N	SUPPLY	DELIVERY	SERVICE	EMERGENCY	CRACK PRESSURE
401227	3/4"	3/8" (x4)	1/4"	1/4"	4.5 PSI



RELAY EMERGENCY VALVE
With Ratio Feature

P/N	SUPPLY	TANK	SERVICE	EMERGENCY	CRACK PRESSURE
401229	3/8" (x4)	3/4"	1/4"	1/4"	4.5 PSI



TP-5 STYLE TRACTOR PROTECTION VALVE
Replaces Control Valve Manifold

P/N	FRONT SERVICE	REAR SERVICE	TRAILER SERV. EMERG.	TRAILER EMERGENCY	TRAILER SERVICE	TRAILER CONTROL	STOP LIGHT SWITCH
401234	3/8" NPT	3/8" NPT	3/8" NPT	1/2" NPT	1/2" NPT	3/8" NPT	1/4" NPT

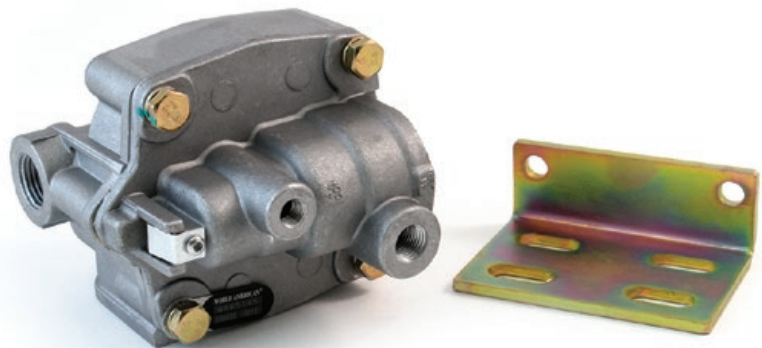

BP-R1 STYLE BOBTAIL PROPORTIONING VALVES
With Mounting Bracket

P/N	SUPPLY	DELIVERY	SERVICE	CONTROL	CRACK PRESSURE
401235	1/2"	3/8" (x4)	1/4"	1/8"	4.0 PSI
401236	1/2"	3/8" (x4)	1/4"	1/8"	5.5 PSI



THE TEV[®] & STEV[®]

Tramec Sloan's Spring Brake Valves Provide Trailer Spring Brake Control & Gladhand Pressure Protection

- There is NO Spring Brake Drag with the TEV and STEV Systems
- Allows the Elimination of the Protected Reservoir
- Sealed Hard Anodized Finish for **200+ Hours of Salt Spray Resistance!**
- **A Trailer OEM Favorite!**
- Their Small Size is Gentle on Tanks: Valves Weigh Less than Two Pounds
- Easy to Install & Convert from Old Systems
- Fully Compatible with Anti-Lock Systems

THE TEV[®] Trailer Emergency Valve

Provides spring brake priority for direct control of the trailer spring brakes.

The logic of the TEV retains the driver's ability to repeatedly apply and release the parking & emergency brakes, even with a damaged tank.

P/N	DESCRIPTION	SUPPLY PORT	CONTROL PORT	RESERVOIR PORT	DELIVERY PORTS (X4)
51301	TEV Assembly	1/4"-18	1/4"-18	3/4"-14	3/8"-18
51302	TEV Assembly	3/8"-18	3/8"-18	1/2"-14	3/8"-18
51305	TEV Rebuild Kit	-	-	-	-

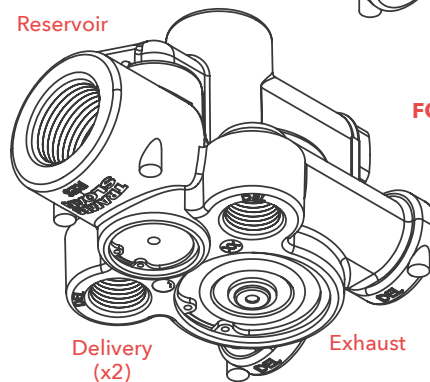
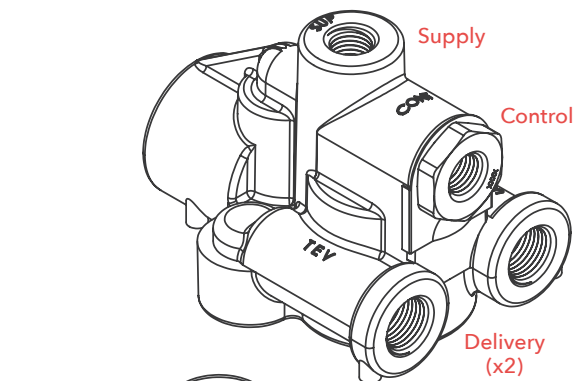

**SEE PAGE 376
FOR INSTALLATION
GUIDES**

HIGH-QUALITY MANUFACTURING

All the components of our valves must first be approved by our **quality assurance processes** before assembly can begin.

Once these are approved, sub-assemblies are built for each functional section of the TEV & STEV and installed in the anodized body.

Then, completed valves are run across end-of-line test standards. **The testing assures the performance of the valve** through six functional assessments and lastly, leak testing.



THE STEV® "Sensing" Trailer Emergency Valve

Provides service brake priority to assure adequate supply is available from the tractor.

The logic of the STEV assures that the trailer parking brakes will not release before there is sufficient air pressure in the reservoir to apply service brakes.

P/N	DESCRIPTION	SUPPLY PORT	CONTROL PORT	RESERVOIR PORT	DELIVERY PORTS (X4)
51321	STEV Assembly	1/4"-18	1/4"-18	3/4"-14	3/8"-18
51322	STEV Assembly	3/8"-18	3/8"-18	1/2"-14	3/8"-18
51325	STEV Rebuild Kit	-	-	-	-

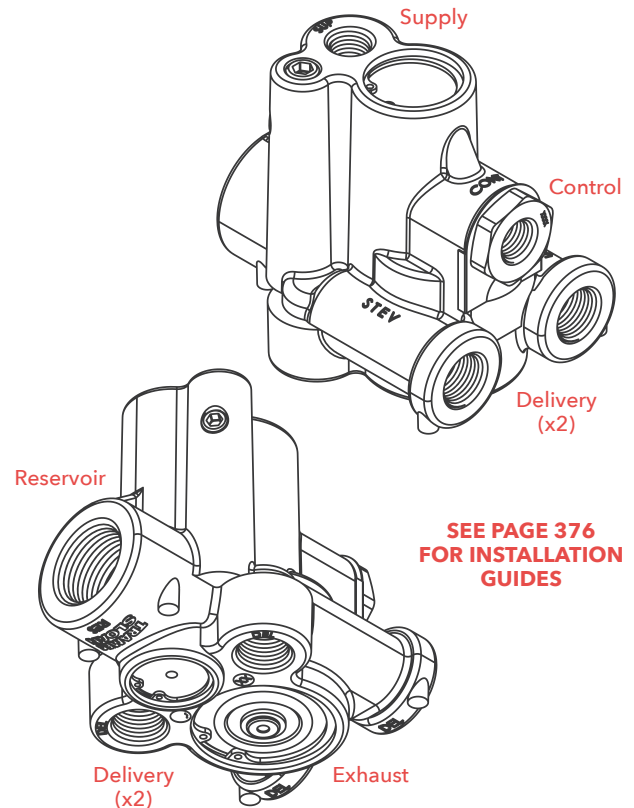

AIR BRAKE VALVES

SR5 STYLE VALVES

- Used on Trailers with Dual Air Brake Systems
- Replaces Bendix Style Trailer Spring Brake Valves
- Meets FMVSS-121 Requirements

P/N	SUPPLY	DELIVERY	RESERVOIR	SERVICE
401188	1/4"	3/8" (x4)	3/4"	1/2" (x2)
401189	1/4"	3/8" (x4)	1/2"	1/2" (x2)



LIMITING VALVES

- Replaces Bendix LQ-2 Limiting Valve



P/N	SUPPLY	DELIVERY	EXHAUST
401281	3/8"	3/8"	-
401283	3/8"	1/4"	3/8"

3-WAY PILOT VALVE

- Replaces Neway #9054079
- 1/4" Ports



P/N	DESCRIPTION
401284	3-Way Pilot Valve

RT-4 STYLE MULTIFUNCTIONAL TRAILER VALVE

- 55 PSI Closing Pressure

P/N	SUPPLY	DELIVERY	CONTROL	RESERVOIR
401223	3/8" (x2)	3/8" (x4)	3/8"	1/2" & 3/8"



FF-2 STYLE FULL FUNCTION VALVE

- 3 PSI Cracking Pressure

P/N	SUPPLY	CONTROL	RESERVOIR	SERVICE BRAKE	SPRING BRAKE
401221	3/8"	1/4"	3/4"	3/8" (x4)	3/8" (x2)



LIFT AXLE CONTROL MODULE

Ready for Installation! Tramec Sloan's Lift Axle Control Module Reduces Parts by 50% Compared to Other Lift Axle Circuitries

Designed to Electronically Control the Raising and Lowering of a Lift Axle by Inflating & Deflating the Air Bags. The Module Incorporates a 4-Way Valve, Regulator, DOT Cartridge Push-In Fittings, Automatic Solenoid, and Air Gauge.

- Designed to Reduce Assembly Time & Errors Current Lift Axle Circuitries Present
- Features Protected Exhaust Ports
- Temperature Rating of -40°F to 160°F
- SAE J1128 and IP65 Compliant
- Solenoid Rated for 9-16 VDC

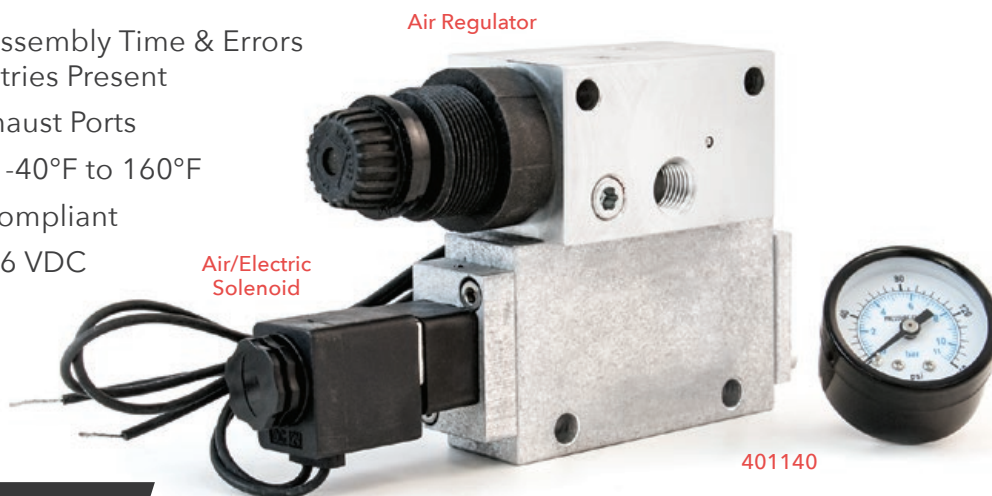

INSTALLATION DIAGRAMS: PAGE 367

P/N	AXLE	GAUGE	REGULATOR/SOLENOID
401138	Normally Down	✓	On Opposite Sides
401139	Normally Down	-	On Opposite Sides
401140	Normally Up	✓	On Same Side
401141	Normally Up	-	On Same Side
401777		Replacement Solenoid	
401778		Replacement Gauge	

HI-FLOW LIFT AXLE VALVE WITH SOLENOID

- Provides Rapid Electric Over Air Control of Lift Axles
- Includes Two Industry-Proven Brake-Style Relay Valves Integrated Into a Single Unit for Compactness and Ease of Installation
- Excellent Flow Capability for Rapid Axle Actuation
- Optional Control Solenoid for Electric Control
- Operating Pressure: 30-120 PSI
- Operating Temperature: -40°F to 190°F
- Replaces: Packar #5040-31102 & 5040-311-01C

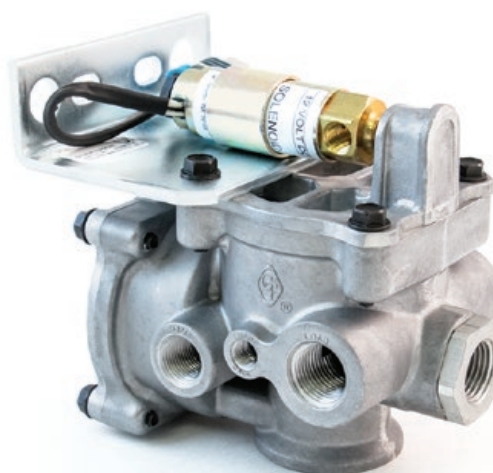

P/N	DESCRIPTION
401349	Hi-Flow Lift Axle Valve with Solenoid

HEAVY DUTY 4-WAY, 3-POSITION AIR VALVE

- This 3-Position, Detented Spool Allows for Adjusting Linkage without Shutting Off Air Pressure
- Center Position Blocks Air at Valve while Opening Both Cylinder Ports to Atmosphere
- 1/4" NPT Ports
- 5/8" Dia. Mounting Hole Required

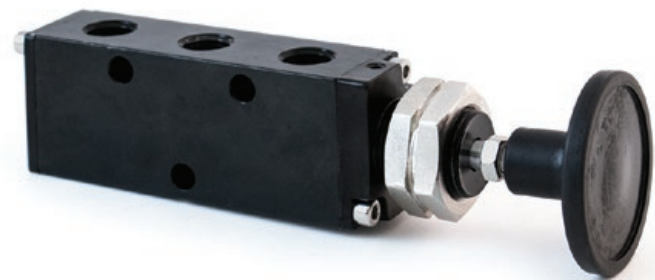

P/N	DESCRIPTION
401261	HD 4-Way, 3-Position Air Valve

4-WAY, 2-POSITION AIR VALVE

- For Double-Acting Cylinders
- Includes Tailgate Faceplate
- 1/2" Dia. Mounting Hole Required

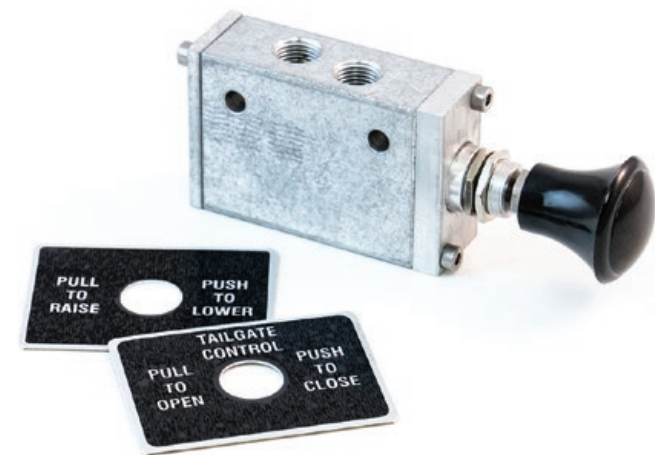

P/N	DESCRIPTION
401262	4-Way, 2-Position Air Valve

4-WAY, 2-POSITION SOLENOID VALVE

- Manual Operation Override Button
- Five 1/4" NPT Ports
- 2' 12-Volt Lead
- Includes Two 1/4" Breathers
- **See Pages 367-375 for Installation Diagrams**



P/N	DESCRIPTION
401263	4-Way, 2-Position Solenoid Valve

EXHAUST MUFFLERS

P/N	DESCRIPTION
401747	1/8" Exhaust Muffler
401748	1/4" Exhaust Muffler
401749	3/8" Exhaust Muffler



MANUAL PUSH/PULL VALVES

- Made in the USA!
- Dump Valve
- Black Anodized Aluminum Body
- Temp Range: -40°F to 180°F
- 1/4" NPT



P/N	DESCRIPTION	MAX PRESSURE
401796	4-Way, 2-Position Push/Pull Detented	200 PSI
401801	4-Way, 3-Position Push/Pull Detented, Center Position Ports Blocked VL.	150 PSI
401802	1/4" 5/3 Push/Pull Detent, 3-Position Exhaust Center, 2 & 4 Open to Exhaust	200 PSI
401803	5/3 Push/Pull Valve Blocked Center Panel Mount	200 PSI

INSTALLATION DIAGRAMS: PAGES 367-375

ELECTRIC AIR VALVES

- Made in the USA!
- Transportation - Air Brake Systems, Air Suspension Systems & Cabin Controls for Trucks, Trailers, RVs, Buses, and More!
- Temperature Range: -40°F to 180°F
- Black Anodized Aluminum Bodies
- **401798/401799:** Can Either Be Controlled Manually or Electronically with 12 VDC Connection
- **401798/401799:** Features 3/8" O.D. Push-to-Connect DOT Fittings for Easy Installation & Service



P/N	DESCRIPTION
401798	Lift Axle Regulated, Push/Turn Lock Override
401799	Lift Axle Non-Regulated, Push/Turn Lock Override
401800	5/2 Solenoid Valve Spring Return, Max. Pressure 150 PSI
401811	4-Way Solenoid Valve with Manual Override, 3/8" NPT Ports, 12VDC, Internal Pilot

CONTROL BOXES

Trans-D.O.T. Axle Control & Suspension Dump Boxes

- 100% TESTED: Every Unit Tested for Function & Airtight Operation
- LIGHTWEIGHT & COMPACT: 30-40% Smaller & Up to 50% Lighter than Competing Models
- TOUGH & DEPENDABLE: Rugged All-Weather Box, Corrosion-Resistant Valves & Fittings
- KEEPS GAUGE CLEAN: Dumps Air & Any Dirt/Contaminants to the Outside
- EASY TO INSTALL & MAINTAIN: Optimized for Operator & Installer Convenience
- FOR ALL HEAVY-DUTY TRAILER TYPES:
 - Short & Long-Haul Trailers
 - Grain Haulers
 - Tankers
 - Gravel Haulers
 - Flatbeds
 - And More!

AXLE CONTROL BOX

Regulated

- Regulated Lift Axle Control Module
- Clear Lid
- Manual Override
- Axle Normally Up
- 3/8" Air Line Connections
- 12 VDC
- 0-160 PSI Gauge
- Box Dimensions: 10" x 8" x 6"

P/N	DESCRIPTION
401807	Axle Control Box - Regulated



AXLE CONTROL BOX

Dual Pressure Supply

- HCV Supplied Lift Axle Control Module
- Clear Lid
- Manual Override
- Axle Normally Up
- 12 VDC
- 3/8" Air Line Connections
- 0-160 PSI Gauge
- Box Dimensions: 10" x 8" x 6"

P/N	DESCRIPTION
401808	Axle Control Box - Dual Pressure Supply



SUSPENSION DUMP CONTROL BOX

With Gauge & Reset

- Manual Suspension Dump Box
- Pull to Fill, Push to Dump
- Air Pilot Reset
- 3/8" Air Line Connections
- 0-160 PSI Gauge
- Box Dimensions: 6" x 6" x 4"

P/N	DESCRIPTION
401804	Suspension Dump Control Box with Gauge & Reset



SUSPENSION DUMP CONTROL BOX

With Side Port

- Manual Suspension Dump Box
- Pull to Fill, Push to Dump
- Air Lines Out the Latch Side
- 3/8" Air Line Connections
- 0-100 PSI Gauge
- Box Dimensions: 6" x 6" x 4"

P/N	DESCRIPTION
401805	Suspension Dump Control Box with Side Port

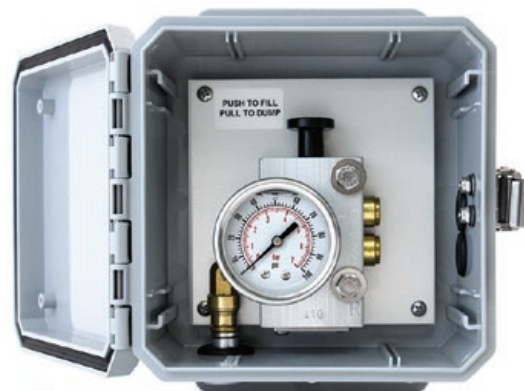

SUSPENSION GAUGE CONTROL BOX

- Displays Suspension Pressure on Gauge
- 0-160 PSI Gauge
- 3/8" Air Line Connection
- Box Dimensions: 6" x 6" x 4"

P/N	DESCRIPTION
401806	Suspension Gauge Control Box

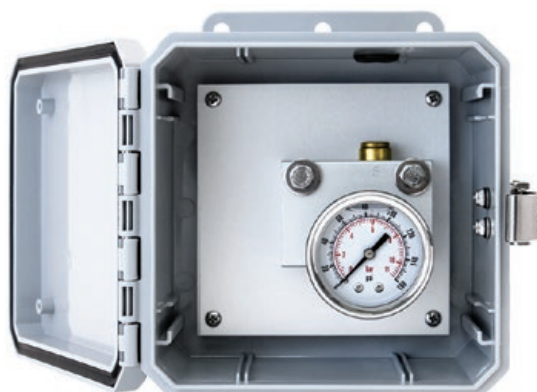

CONTROL BOX GAUGE

- 0-160 PSI Gauge
- 2.0" Diameter

P/N	DESCRIPTION
401809	Liquid-Filled Gauge SS



3-WAY PUSH/PULL WITH AIR RESET

- Made in the USA!
- Transportation - Air Brake Systems, Air Suspension Systems & Cabin Controls for Trucks, Trailers, RVs, Buses, and More!
- Temperature Range: -40°F to 180°F
- Maximum Pressure: 200 PSI
- Reset Pressure: 40 PSI
- The Rear of the Spool is Vented to Exhaust Port

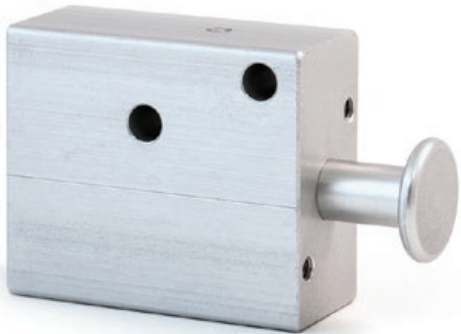

P/N	DESCRIPTION
401797	3-Way Push/Pull with Air Reset

3-WAY MULTI-PURPOSE SOLENOID VALVE

- Made in the USA!
- Transportation - Air Brake Systems, Air Suspension Systems & Cabin Controls for Trucks, Trailers, RVs, Buses, and More!
- Max. Operating Pressure: 100 PSI
- Voltage: 12 VDC
- 1/4" NPT Ports
- Stainless Steel



P/N	DESCRIPTION
401810	Peter Paul 3-Way Multi-Purpose Solenoid Valve

RAPID DUMP AIR SUSPENSION VALVE

- Replaces Bendix TR-3, SV-1 and Humphrey 250A N/O valves
- Pilot Operated
- Rapidly Exhausts Air from Suspension Air Springs
- Mounts on Frame Rails Using 1/4" Mounting Holes
- Four 1/8" FTP Ports
- Dual Delivery Design Allows for Convenient In-Line Plumbing of Air Spring Lines and Eliminates Need for Tee Fittings

P/N	DESCRIPTION
401148	Rapid Dump Air Suspension Valve
401148GT	Rapid Dump Air Suspension Valve, GT Development



401148

AIR & AIR-ELECTRIC TOGGLE & FLIPPER VALVES

- Used for a Variety of Air & Air-Electric Applications Such as Air Suspensions, Lift Axles, Fifth Wheel Sliders and Differential Locks
- Push-to-Connect Fittings Mate Easily with 1/4" Nylon Tubing
- Max. Operating Pressure: 150 PSI
- Includes All Necessary Mounting Hardware
- Air-Electric Switches Include a Pressure Switch and Terminals for Indicator Lamps
- 5 Amp Resistive Current Load at 12 VDC
- Terminal Size: 1/4" Blade
- Pressure Switch: Open Below 10 PSI, Closed Above 35 PSI
- Switch Off Position: No Air flow, Electrical Contacts Open. Supply is Blocked, Delivery is Vented
- Switch On Position: Air Flows through Valve, Electrical Contacts Closed. Supply is Connected to Delivery

AIR & AIR-ELECTRIC TOGGLE VALVES



P/N	DESCRIPTION	TOGGLE TYPE
401157	Air-Electric, 3-Way Toggle Valve	Paddle
401158	Air-Electric, 3-Way Toggle Valve	Blade
401159	Air-Electric, 3-Way Toggle Valve	Bat
401160	Air 3-Way Toggle Valve	Paddle
401161	Air 3-Way Toggle Valve	Blade
401311	Air & Air-Electric	Bat

AIR & AIR-ELECTRIC FLIPPER VALVES



P/N	DESCRIPTION	LEVER POSITIONS
401162	Air-Electric, 3-Way Flipper Valve	On / Off / Exhaust
401163	Air 3-Way Flipper Valve	On / Off / Exhaust

AIR ACCESSORY VALVES

AIR HORN ACTUATOR VALVES



401164 / 401253



401165



401254



401308



401257



401255

P/N	DESCRIPTION	PORTS	APPLICATION
401164	Air Horn Valve	1/4" (x2)	Kenworth
401165	Air Horn Valve	3/8" (x2)	Navistar
401253	Air Horn Valve	1/4" (x3)	Kenworth
401254	Air Horn Valve	1/4" (x3), 3/8"	Freightliner - Dual Outlet
401255	Air Horn Valve	1/4" (x3), 3/8"	Freightliner
401256	Air Horn Valve	3/8" (x2)	Navistar
401257	Air Horn Valve	3/8" (x2)	Navistar
401308	Air Horn Valve	STD	Bendix

HEIGHT/LUMBAR CONTROL SEAT VALVES

- Controls Air Ride Truck Seats & Lumbar Supports
- Electro-Pneumatic Combination Valve Designed to Operate Air Seats Using an Electric Air Compressor
- Spring-Loaded, 3-Way Function



401149



401147



401150



401151

P/N	DESCRIPTION	PORTS
401147	End & Side Ported with Removable Chrome Knob	1/8" FPT (x2)
401149	Paddle Type	3/16" Barb (x2)
401150	End Ported with Removable Chrome Knob	1/8" FPT (x2)
401151	Electro-Pneumatic with Removable Black Knob and Two 1/4" Blade Terminals	1/4" (x3), 3/8"

SOLENOID AIR VALVE

- Normally Closed



P/N	DESCRIPTION
401816	Solenoid Air Valve, Normally Closed

SOLENOID AIR VALVE

- 12 VDC

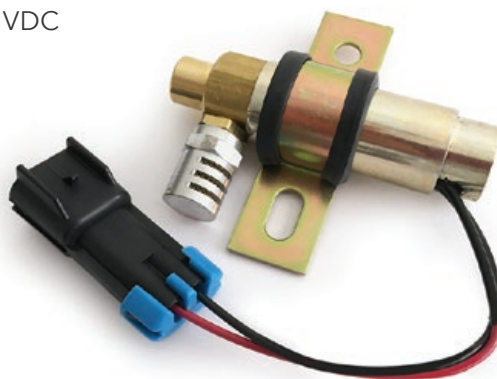

P/N	DESCRIPTION
401817	Solenoid Air Valve, 12 Volt DC

3-WAY SOLENOID VALVE

- 12 VDC
- On/Off Exhaust Function
- Inlet Port Normally Closed
- Install Vertically with Port Up



P/N	PORTS	OPERATING PRESSURE
401190	1/4" FPT (x2)	100-120 PSI

FILTER ASSEMBLY

- Replaces Eaton/Fuller A4740

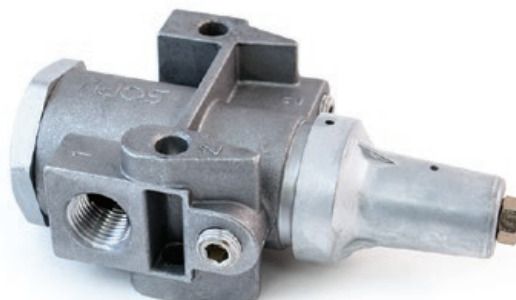

P/N	SUPPLY	DELIVERY	PSI
401304	3/8"	1/8" (x3)	55-65

FILTER REGULATOR KIT

- Replaces Eaton/Fuller K2170
- Plug Bottom for A-5161

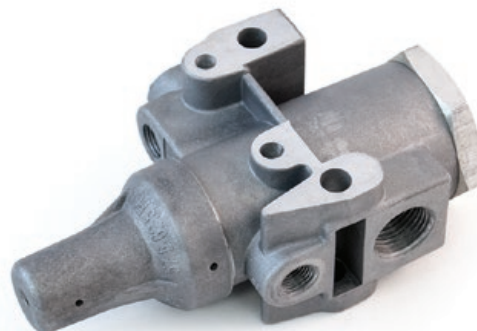

P/N	SUPPLY	DELIVERY	PSI
401305	1/8"	1/8" (x3)	57-65

AIR ACCESSORY VALVES

PRESSURE REGULATOR

- Replaces Eaton/Fuller 16743

P/N	SUPPLY	DELIVERY	PSI
401306	1/4"	1/8"	55-65



PRESSURE REGULATOR

- Replaces Meritor/Rockwell A-3280-9072

P/N	SUPPLY	DELIVERY	PSI
401307	3/8"	1/8" (x3)	55-70

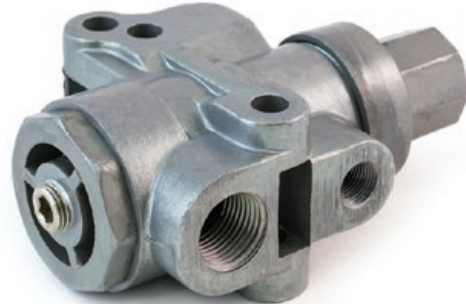

AIR DRYER REPLACEMENT CARTRIDGES



P/N	DESCRIPTION	APPLICATION
401217	Air Dryer Replacement Cartridge	WABCO Spin-On Valve, AD-SP Type, Saver 2000
401218	Air Dryer Replacement Cartridge	Bendix - AD-4 Air Dryers
401219	Air Dryer Replacement Cartridge	Bendix - AD-9 Air Dryers

AIR BRAKE DIAPHRAGMS



P/N	DESCRIPTION	TYPE	DIAMETER
461209	Air Brake Diaphragm	9	5"
461212	Air Brake Diaphragm	12	5-1/2"
461216	Air Brake Diaphragm	16	6"
461220	Air Brake Diaphragm	20	6-1/2"
461224	Air Brake Diaphragm	24	7"
461230	Air Brake Diaphragm	30	8"
461236	Air Brake Diaphragm	36	9"

TAILGATE AIR CYLINDER

P/N	BORE	STROKE
400256	2.5"	6"
400258	2.5"	8"
400356	3.5"	6"
400358	3.5"	8"

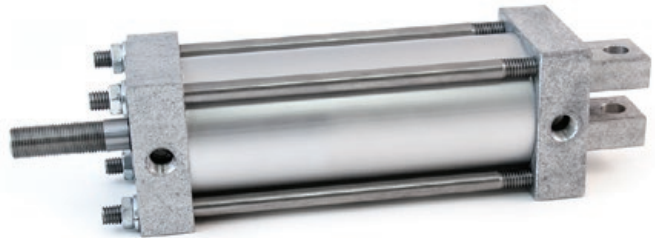

5TH WHEEL CYLINDER

Air Return

P/N	BORE	STROKE
401267	2-3/4"	6-3/4"



FORGED YOKE KIT

Includes Yoke, Pin, and Cotter Pin

P/N	DESCRIPTION	CHAMBER
401242	5/8" Thread Clevis Assembly, 1/2" Pin	20, 24, 30
401243	1/2" Thread Clevis Assembly, 1/2" Pin	9, 12, 16



FITTINGS & FASTENERS

MANUFACTURING FITTINGS IN THE UNITED STATES

Our 144,000 square ft. plant in Galion, Ohio is home to more than 50 machines for forging & machining brass fittings as well as quality control and testing labs. Manufacturing our own brass fittings allows us to provide exceptional brass fill rates. We convert more than **9 million pounds of brass each year** for our extruded and forged fittings.

Tramec Sloan is the Trusted Brass Supplier to Many Heavy Duty OEMs Across the Country.

FEATURES OF BRASS FITTINGS

Brass is a material that is easily machined and can be given any shape for various types of fittings. Brass fittings are widely used in many markets from industrial to residential because of their strength and durability. The brass fittings have a distinct look due to their yellow color.

Brass fittings are highly demanded because of unique features such as:

- Excellence in Corrosion Resistance
- Excellent High Temperature Ductility
- Good Bearing Properties
- Characterized by Good Strength
- Low Magnetic Permeability
- Good Conductivity





IN THIS SECTION:

FITTINGS	Captive Sleeve Compression Fittings	170
Quick-Fix® Kits	Hose Barbs	172
Nylon Tube Fittings	Low-Pressure, Push-On Hose Barbs	175
Brass D.O.T. Push-In Air Brake Fittings	Garden Hose Fittings	177
Composite D.O.T. Push-In Air Brake Fittings..	Grease Fittings	180
Rubber Hose Air Brake Fittings	Truck & Ball Valves	182
Copper Tube Air Brake Fittings	Drain Cocks & Shut-Off Valves	184
Bulkhead Fittings	Lead Free Fittings	187
Transmission Fittings	PTFE Fittings	190
Pipe Fittings	TUBE & THREAD CHARTS	191
45° Flare Fittings	BIN ASSORTMENTS	192
Inverted Flare Fittings	FASTENERS	196
Compression Fittings		

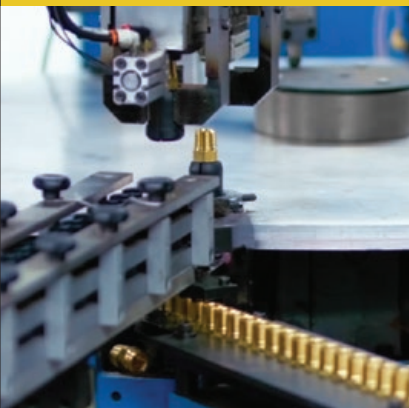

QUICK-FIX® KITS

THIS IS WHERE IT ALL BEGAN.

The Original End Fitting Kit, 31402, was the very first product developed by Tramec Sloan (then, Hose America) when it was founded in 1981. It was invented in Iola, Kansas by Sergio Campanini, founder of the company. He was joined by Gil Brown, Jim Hopper and Bill Lee as stock holders when the company was incorporated.

The "Swivel Hose Coupling" patent was applied for October 6, 1980 and granted August 10, 1982. This invention then led to the development of the remainder of the "live swivel" fitting line. First utilized by Monon Trailer and now by trailer manufacturers all over the world!

*"These Things Are
a Life Saver!"*

QUICK-FIX® 31402
HOSE END REPAIR KIT

(8" NPTF SWIVEL ENDS FOR DOT A,
3/8" I.D.) AIR BRAKE HOSE

TRAMEC
SLOAN

THE ORIGINAL QUICK-FIX® KITS

Tramec Sloan's Hose End Repair Kits are the First & Best of their Kind. More than a Temporary Solution; They're a Permanent Fix!



QUICK-FIX® FOR 3/8" HOSE

- Designed and Made in the USA
- One Pack Will Repair Two Damaged 3/8" Rubber Air Brake Lines
- Meets DOT 106 & SAE J1402 Requirements
- Clamshell Pack Features Pre-Sealed Threads & Includes Installation Tool
- Available with 3/8" or 1/2" Live Swivel Fittings



P/N	DESCRIPTION	PACKAGE
431402	3/8" NPTF Quick-Fix Kit	Clamshell Pack
431403	1/2" NPTF Quick-Fix Kit	Clamshell Pack
31402*	3/8" NPTF Quick-Fix Kit	Classic Tube
31403*	1/2" NPTF Quick-Fix Kit	Classic Tube
31407*	3/8" NPTF & 1/4" NPTF Adapter	Classic Tube
31408*	3/8" NPTF with 3-1/2" Spring Guard	Classic Tube
31410	Universal Kit: 3/8" End Fitting with 1/4" NPTF Adapter, 1/2" NPTF Reducer, and 3/8" x 3/8" NPTF Couple	Classic Tube

* Add the Prefix "P" to the Part Number for Thread Sealant; Add the Suffix "B" to Specify a Brass Barb for Gladhand Use

"Every Driver Should Have These in Their Cab"



31402POP



431406

QUICK-FIX® RETAIL DISPLAYS

P/N	DESCRIPTION
31402POP	Counter-Top POP Display with 15 Tubes (3/8" NPTF Quick-Fix P/N 31402)
431405D	Counter-Top Display Rack without Stock
431405	Counter-Top Display Rack with Stock: 12 Clamshell Kits (3/8" NPTF Quick-Fix P/N 431402)
431406	Counter-Top Display Rack with Stock: 12 Clamshell Kits 1/2" NPTF Quick-Fix P/N 431403)
431402-12	3/8" NPTF Quick-Fix Kits - 12 Clamshell Packs (Display Refill)
431403-12	1/2" NPTF Quick-Fix Kits - 12 Clamshell Packs (Display Refill)

BULK QUICK-FIX®

Unpackaged Assemblies for Production Use. Must be Pressed on Hose.

P/N	DESCRIPTION
31302*	3/8" NPTF for 3/8" Hose - 200 Assemblies
31303*	1/2" NPTF for 3/8" Hose - 200 Assemblies
31305*	3/8" NPTF for 1/2" Hose - 162 Assemblies
31306*	1/2" NPTF for 1/2" Hose - 162 Assemblies
431402-100	3/8" NPTF for 3/8" Hose with Thread Sealant - 100 Assemblies
431403-100	1/2" NPTF for 3/8" Hose with Thread Sealant - 100 Assemblies

* Add the Prefix "P" to the Part Number for Thread Sealant

* Add the Suffix "B" to the Part Number to Specify a Brass Barb for Gladhand Use

ALL-BRASS QUICK-FIX® KITS

Tramec Sloan's Hose End Repair Kits are the First & Best of their Kind. More than a Temporary Solution; They're a Permanent Fix!



QUICK-FIX® FOR 1/2" HOSE

- Made in the USA!
- Durable All-Brass Construction
- One Pack Will Repair Two Damaged 1/2" Rubber Air Brake Lines
- Meets DOT 106 & SAE J1402 Requirements
- Available with 3/8" or 1/2" Live Swivel Fittings
- Features Pre-Applied Thread Sealant and Greased Barbs
- Includes Step-by-Step, Illustrated Instructions for Installation

P/N	DESCRIPTION	PACKAGE
431408	3/8" NPTF Brass Quick-Fix	Classic Tube
431408-100	3/8" NPTF Brass Quick-Fix	100 Unpackaged Assemblies
431410	1/2" NPTF Brass Quick-Fix Kit	Classic Tube
431410-100	1/2" NPTF Brass Quick-Fix Kit	100 Unpackaged Assemblies

**QUICK-FIX® INSTALLATION
INSTRUCTIONS: PAGES 365-366**



QUICK-FIX® FIELD REPAIR FITTING KITS

- Brass & Composite Fitting Kits for Convenient Field Repairs
- Visual Key Inside the Lid Makes it Simple to Quickly Find the Part You Need!
- Designed & Assembled in the USA!



QUICK-FIX® REPAIR KIT 424314

Air Brake Line Kit

Includes 21 Composite Fittings:

- S762PMT-6 (x2)
- S762PMT-8 (x2)
- S764PMT-6 (x2)
- S764PMT-8 (x2)
- S768PMT-6-6 (x2)
- S768PMT-6-8
- S768PMT-8-4
- S768PMT-6 (x2)
- S768PMT-8-8
- S769PMT-6-6 (x2)
- S769PMT-6-8
- S769PMT-8-4
- S769PMT-8-6
- S769PMT-8-8

P/N	DESCRIPTION
424314	Quick-Fix Repair Kit - Air Brake Line Kit



QUICK-FIX® REPAIR KIT 424315

NTA Kit

Includes 31 of Tramec Sloan's American Made Brass Fittings:

- S762AB-4 (x2)
- S762AB-6 (x2)
- S762AB-8 (x2)
- S762AB-10 (x2)
- S768AB-4-2 (x2)
- S768AB-4-4 (x3)
- S768AB-6-4 (x2)
- S768AB-6-6
- S768AB-8-6
- S769AB-4-2 (x2)
- S769AB-4-4 (x3)
- S769AB-6-4 (x2)
- S769AB-6-6 (x3)
- S769AB-8-6 (x2)
- S769AB-8-8 (x2)

P/N	DESCRIPTION
424315	Quick-Fix Repair Kit - NTA Kit

QUICK-FIX® REPAIR KIT 424316

Transmission Kit

Includes 10 Composite Fittings & Tube Cutter:

- 451100
- S762PMT-532
- S762PMT-3
- S768PMT-2-1
- S768PMT-2-2
- S768PMT-532-1 (x2)
- S768PMT-532-2 (x2)
- S769PMT-2-2
- S769PMT-532-2



P/N	DESCRIPTION
424316	Quick-Fix Repair Kit - Transmission Kit

QUICK-FIX® REPAIR KIT 424317

In-Cab Air Line Kit

Includes 24 Composite Fittings:

- S762PMT-2 (x2)
- S762PMT-3 (x2)
- S762PMT-4 (x2)
- S762PMT-6
- S764PMT-2
- S764PMT-3
- S764PMT-4
- S764PMT-6
- S768PMT-2-2 (x2)
- S768PMT-2-4 (x2)
- S768PMT-4-2 (x2)
- S768PMT-4-4 (x2)
- S768PMT-6-2
- S768PMT-6-4
- S769PMT-4-2
- S769PMT-4-4
- S769PMT-6-4



P/N	DESCRIPTION
424317	Quick-Fix Repair Kit - In-Cab Air Line Kit





NYLON TUBE FITTINGS

APPLICATIONS

Use with SAE J844 Nylon Air Brake Tubing in Air Brake Systems or In-Cab Air Controls

WORKING PRESSURE

Up to 150 PSI

TEMPERATURE RANGE

-40°F to 200°F (-40°C to 93°C)

STANDARD COMPLIANCE

Made to SAE J246 dimensions and DOT FMVSS 571.106

ASSEMBLY INSTRUCTIONS

1. Cut Tubing Squarely (Maximum 15° Angle)
2. Check that the Port of the Mating Part is Clean and Free of Debris
3. Insert Tubing into Fitting Until it Bottoms
4. Tighten Nut with Wrench Until Only One Thread Remains Visible (This Allows for a Number of Remakes)

ORDERING OPTIONS

Add Suffix "V" to the Part Number to Order with Pre-Applied Thread Sealant on Male Pipe Threads

[A] NYLON TUBE SLEEVE

P/N	TUBE
S760AB-3	3/16"
S760AB-4	1/4"
S760AB-6	3/8"
S760AB-8	1/2"
S760AB-10	5/8"
S760AB-12	3/4"

[B] NYLON TUBE NUT

P/N	TUBE
S761AB-4	1/4"
S761AB-6	3/8"
S761AB-8	1/2"
S761AB-10	5/8"
S761AB-12	3/4"

[C] TUBE SUPPORT

Stainless Steel, Drop-In Style

P/N	TUBE
S763AB-4	1/4"
S763AB-6	3/8"
S763AB-8	1/2"
S763AB-10	5/8"
S763AB-12	3/4"

[D] TUBE SUPPORT

Brass, Push-In Style

P/N	TUBE
984-4W	1/4"
984-6W	3/8"
984-8W	1/2"
984-10W	5/8"
984-12W	3/4"



[E] MALE CONNECTOR

P/N	TUBE	PIPE
S768AB-4-2	1/4"	1/8"
S768AB-4-4	1/4"	1/4"
S768AB-4-6	1/4"	3/8"
S768AB-6-2	3/8"	1/8"
S768AB-6-4	3/8"	1/4"
S768AB-6-6	3/8"	3/8"
S768AB-6-8	3/8"	1/2"
S768AB-8-4	1/2"	1/4"
S768AB-8-6	1/2"	3/8"
S768AB-8-8	1/2"	1/2"
S768AB-10-6	5/8"	3/8"
S768AB-10-8	5/8"	1/2"
S768AB-10-12	5/8"	3/4"
S768AB-12-8	3/4"	1/2"
S768AB-12-12	3/4"	3/4"

[F] FEMALE CONNECTOR

P/N	TUBE	PIPE
S766AB-4-2	1/4"	1/8"
S766AB-4-4	1/4"	1/4"
S766AB-6-2	3/8"	1/8"
S766AB-6-4	3/8"	1/4"
S766AB-6-6	3/8"	3/8"
S766AB-8-6	1/2"	3/8"
S766AB-8-8	1/2"	1/2"
S766AB-10-6	1/2"	3/8"
S766AB-10-8	5/8"	1/2"

[G] BULKHEAD UNION

P/N	TUBE
S774AB-4	1/4"
S774AB-6	3/8"
S774AB-8	1/2"

[H] UNION

P/N	TUBE
S762AB-4	1/4"
S762AB-6	3/8"
S762AB-8	1/2"
S762AB-10	5/8"
S762AB-12	3/4"

[I] MALE ELBOW

P/N	TUBE	PIPE
S769AB-4-2	1/4"	1/8"
S769AB-4-4	1/4"	1/4"
S769AB-4-6	1/4"	3/8"
S769AB-6-2	3/8"	1/8"
S769AB-6-4	3/8"	1/4"
S769AB-6-4L*	3/8"	1/4"
S769AB-6-6	3/8"	3/8"
S769AB-6-8	3/8"	1/2"
S769AB-8-4	1/2"	1/4"
S769AB-8-6	1/2"	3/8"
S769AB-8-6L*	1/2"	3/8"
S769AB-8-8	1/2"	1/2"
S769AB-10-6	5/8"	3/8"
S769AB-10-8	5/8"	1/2"
S769AB-10-12	5/8"	3/4"
S769AB-12-8	3/4"	1/2"
S769AB-12-12	3/4"	3/4"

* Indicates Longer Body than Standard Part

NYLON TUBE FITTINGS



[A] 45° ELBOW

P/N	TUBE	PIPE THREAD
S779AB-4-2	1/4"	1/8"
S779AB-4-4	1/4"	1/4"
S779AB-6-2	3/8"	1/8"
S779AB-6-4	3/8"	1/4"
S779AB-6-6	3/8"	3/8"
S779AB-6-8	3/8"	1/2"
S779AB-8-4	1/2"	1/4"
S779AB-8-6	1/2"	3/8"
S779AB-8-8	1/2"	1/2"
S779AB-10-6	5/8"	3/8"
S779AB-10-8	5/8"	1/2"

[B] FEMALE ELBOW

P/N	TUBE	PIPE THREAD
S770AB-4-2	1/4"	1/8"
S770AB-4-4	1/4"	1/4"
S770AB-6-2	3/8"	1/8"
S770AB-6-4	3/8"	1/4"
S770AB-6-6	3/8"	3/8"
S770AB-8-6	1/2"	3/8"
S770AB-8-8	1/2"	1/2"
S770AB-10-8	5/8"	1/2"

[C] UNION ELBOW

P/N	TUBE
S765AB-4	1/4"
S765AB-6	3/8"
S765AB-8	1/2"
S765AB-10	5/8"

[D] UNION TEE

P/N	TUBE 1	TUBE 2	TUBE 3
S764AB-4	1/4"	1/4"	1/4"
S764AB-4-4-6	1/4"	1/4"	3/8"
S764AB-6	3/8"	3/8"	3/8"
S764AB-6-6-4	3/8"	3/8"	1/4"
S764AB-8-6-8	1/2"	3/8"	1/2"
S764AB-8-8-6	1/2"	1/2"	3/8"
S764AB-8	1/2"	1/2"	1/2"
S764AB-10	5/8"	5/8"	5/8"

[E] MALE BRANCH TEE

P/N	TUBES	PIPE THREAD
S772AB-4-2	1/4"	1/8"
S772AB-4-4	1/4"	1/4"
S772AB-6-4	3/8"	1/4"
S772AB-6-2	3/8"	1/8"
S772AB-6-6	3/8"	3/8"
S772AB-8-4	1/2"	1/4"
S772AB-8-6	1/2"	3/8"
S772AB-8-8	1/2"	1/2"
S772AB-10-8	5/8"	1/2"

[F] MALE RUN TEE

P/N	TUBES	PIPE THREAD
S771AB-4-2	1/4"	1/8"
S771AB-4-4	1/4"	1/4"
S771AB-6-4	3/8"	1/4"
S771AB-6-6	3/8"	3/8"
S771AB-8-6	1/2"	3/8"
S771AB-8-4	1/2"	1/4"
S771AB-8-8	1/2"	1/2"
S771AB-10-8	5/8"	1/2"



BRASS PUSH-TO-CONNECT AIR BRAKE FITTINGS

PRODUCT FEATURES

- Designed to Resist Mechanical Pull-Out
- Easy to Assemble and Disassemble Over and Over Again
- Swivel is for Installation Purposes Only

APPLICATIONS

Use with SAE J844 Nylon Air Brake Tubing

WORKING PRESSURE

Up to 145 PSI

TEMPERATURE RANGE

-40°F to 225°F (-40°C to 107°C)

STANDARD COMPLIANCE

Meets DOT FMVSS 571.106 Standards and SAE J1131, J2494-1, J2494-3

ASSEMBLY INSTRUCTIONS

1. Cut Tubing Squarely (Maximum 15° Angle)
2. Check that the Port of the Mating Part is Clean and Free of Debris
3. Insert Tubing into Fitting Until it Bottoms (Push at Least Twice to Verify that Tubing is Inserted Past Collar and O-Ring)
4. Pull on Tubing to Verify it is Fully Inserted
5. To Disassemble, Simply Press the Release Collar, Holding it Against the Fitting Body & Simultaneously Pull Tubing Out of Fitting

[A] NYLON PLUG

P/N	TUBE
S639PMT-532	5/32"
S639PMT-4	1/4"
S639PMT-6	3/8"
S639PMT-8	1/2"

[B] GLADHAND BULKHEAD STUD

P/N	TUBE	PIPE	THREAD
S983PMT-6-8	3/8"	1/2"	1"-14 UNS
S983PMT-6-8L	3/8"	1/2"	1"-14 UNS
S983PMT-8-8	1/2"	1/2"	1"-14 UNS
S983PMT-8-8L	1/2"	1/2"	1"-14 UNS

NOTE: "L" indicates long body length: 2-25/32"

[C] TUBING UNION

P/N	TUBE
S62PMT-532	5/32"
S62PMT-3	3/16"
S62PMT-4	1/4"
S62PMT-5	5/16"
S62PMT-6	3/8"
S62PMT-8	1/2"
S62PMT-10	5/8"

[D] BULKHEAD UNION

P/N	TUBE	THREAD
S62PMTBH-4	1/4"	1/2"-20
S62PMTBH-6	3/8"	5/8"-18
S62PMTBH-8	1/2"	3/4"-16
S62PMTBH-10	5/8"	15/16"-16

BRASS PUSH-IN FITTINGS

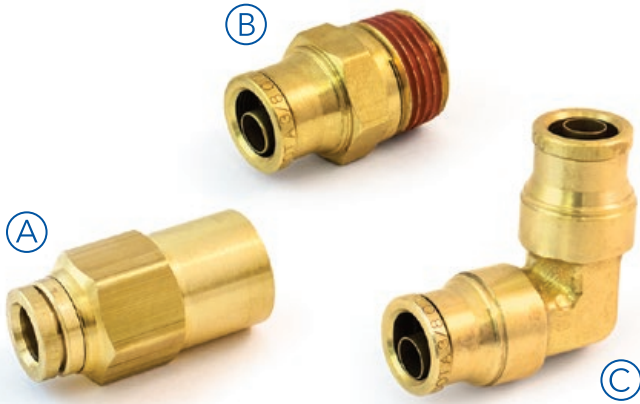

[A] FEMALE CONNECTOR

P/N	TUBE	PIPE
S66PMT-4-2	1/4"	1/8"
S66PMT-4-4	1/4"	1/4"
S66PMT-6-4	3/8"	1/4"
S66PMT-6-6	3/8"	3/8"
S66PMT-8-6	1/2"	3/8"
S66PMT-8-8	1/2"	1/2"

[B] MALE CONNECTOR

P/N	TUBE	PIPE
S68PMT-532-1	5/32"	1/16"
S68PMT-532-2	5/32"	1/8"
S68PMT-3-2	3/16"	1/8"
S68PMT-4-2	1/4"	1/8"
S68PMT-4-4	1/4"	1/4"
S68PMT-4-6	1/4"	3/8"
S68PMT-5-4	5/16"	1/4"
S68PMT-6-2	3/8"	1/8"
S68PMT-6-4	3/8"	1/4"
S68PMT-6-6	3/8"	3/8"
S68PMT-6-8	3/8"	1/2"
S68PMT-8-4	1/2"	1/4"
S68PMT-8-6	1/2"	3/8"
S68PMT-8-8	1/2"	1/2"
S68PMT-10-6	5/8"	3/8"
S68PMT-10-8	5/8"	1/2"
S68PMT-12-8	3/4"	1/2"
S68PMT-12-12	3/4"	3/4"

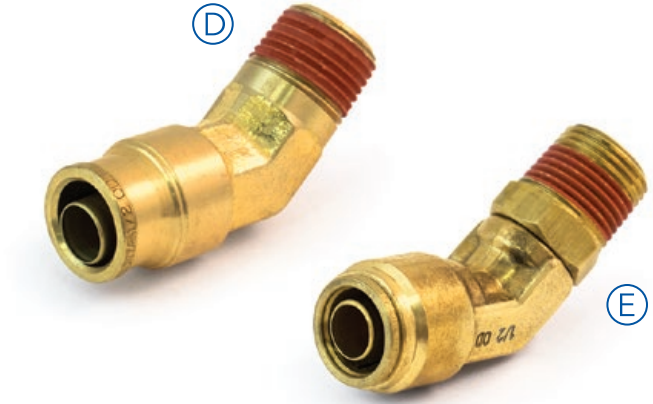

[C] 90° UNION ELBOW

P/N	TUBE
S265PMT-4	1/4"
S265PMT-6	3/8"
S265PMT-8	1/2"

[D] 45° MALE ELBOW

P/N	TUBE	PIPE
S254PMTNS-4-2	1/4"	1/8"
S254PMTNS-4-4	1/4"	1/4"
S254PMTNS-6-2	3/8"	1/8"
S254PMTNS-6-4	3/8"	1/4"
S254PMTNS-6-6	3/8"	3/8"
S254PMTNS-6-8	3/8"	1/2"
S254PMTNS-8-4	1/2"	1/4"
S254PMTNS-8-6	1/2"	3/8"
S254PMTNS-8-8	1/2"	1/2"
S254PMTNS-10-6	5/8"	3/8"
S254PMTNS-10-8	5/8"	1/2"
S254PMTNS-12-12	3/4"	3/4"

[E] 45° MALE ELBOW - SWIVEL

P/N	TUBE	PIPE
S254PMT-4-2	1/4"	1/8"
S254PMT-4-4	1/4"	1/4"
S254PMT-6-2	3/8"	1/8"
S254PMT-6-4	3/8"	1/4"
S254PMT-6-6	3/8"	3/8"
S254PMT-8-4	1/2"	1/4"
S254PMT-8-6	1/2"	3/8"
S254PMT-8-8	1/2"	1/2"
S254PMT-10-8	5/8"	1/2"
S254PMT-12-8	3/4"	1/2"



[F] 90° MALE ELBOW

P/N	TUBE	PIPE
S269PMTNS-532-1	5/32"	1/16"
S269PMTNS-532-2	5/32"	1/8"
S269PMTNS-3-2	3/16"	1/8"
S269PMTNS-4-2	1/4"	1/8"
S269PMTNS-4-4	1/4"	1/4"
S269PMTNS-4-6	1/4"	3/8"
S269PMTNS-6-2	3/8"	1/8"
S269PMTNS-6-4	3/8"	1/4"
S269PMTNS-6-6	3/8"	3/8"
S269PMTNS-6-8	3/8"	1/2"
S269PMTNS-8-4	1/2"	1/4"
S269PMTNS-8-6	1/2"	3/8"
S269PMTNS-8-8	1/2"	1/2"
S269PMTNS-10-6	5/8"	5/8"
S269PMTNS-10-8	5/8"	1/2"
S269PMTNS-12-8	3/4"	1/2"

[G] 90° MALE ELBOW - SWIVEL

P/N	TUBE	PIPE
S269PMT-2-2	1/8"	1/8"
S269PMT-532-2	5/32"	1/8"
S269PMT-4-2	1/4"	1/8"
S269PMT-4-4	1/4"	1/4"
S269PMT-4-6	1/4"	3/8"
S269PMT-5-4	5/16"	1/4"
S269PMT-6-2	3/8"	1/8"
S269PMT-6-4	3/8"	1/4"
S269PMT-6-6	3/8"	3/8"
S269PMT-6-8	3/8"	1/2"
S269PMT-8-4	1/2"	1/4"
S269PMT-8-6	1/2"	3/8"
S269PMT-8-8	1/2"	1/2"
S269PMT-10-6	5/8"	3/8"
S269PMT-10-8	5/8"	1/2"
S269PMT-12-8	3/4"	1/2"
S269PMT-12-12	3/4"	3/4"

[H] 90° FEMALE ELBOW

P/N	TUBE	PIPE
S270PMTNS-4-2	1/4"	1/8"
S270PMTNS-4-4	1/4"	1/4"
S270PMTNS-4-6	1/4"	3/8"
S270PMTNS-6-2	3/8"	1/8"
S270PMTNS-6-4	3/8"	1/4"
S270PMTNS-6-6	3/8"	3/8"
S270PMTNS-8-6	1/2"	3/8"
S270PMTNS-8-8	1/2"	1/2"

[I] MALE BRANCH TEE

P/N	TUBE	PIPE
S272PMTNS-4-2	1/4"	1/8"
S272PMTNS-4-4	1/4"	1/4"
S272PMTNS-6-4	3/8"	1/4"
S272PMTNS-6-6	3/8"	3/8"
S272PMTNS-8-4	1/2"	1/4"
S272PMTNS-8-6	1/2"	3/8"

BRASS PUSH-IN FITTINGS



[A] MALE BRANCH TEE - SWIVEL

P/N	TUBE	PIPE
S272PMT-4-2	1/4"	1/8"
S272PMT-4-4	1/4"	1/4"
S272PMT-6-2	3/8"	1/8"
S272PMT-6-4	3/8"	1/4"
S272PMT-6-6	3/8"	3/8"
S272PMT-8-4	1/2"	1/4"
S272PMT-8-6	1/2"	3/8"
S272PMT-8-8	1/2"	1/2"

[B] MALE RUN TEE

P/N	TUBE	PIPE
S271PMTNS-4-2	1/4"	1/8"
S271PMTNS-4-4	1/4"	1/4"
S271PMTNS-6-4	3/8"	1/4"
S271PMTNS-6-6	3/8"	3/8"

[C] MALE RUN TEE - SWIVEL

P/N	TUBE	PIPE
S271PMT-4-2	1/4"	1/8"
S271PMT-4-4	1/4"	1/4"
S271PMT-6-4	3/8"	1/4"
S271PMT-6-6	3/8"	3/8"
S271PMT-8-6	1/2"	3/8"
S271PMT-8-8	1/2"	1/2"

[D] UNION TEE

P/N	TUBE
S264PMT-4	1/4"
S264PMT-6	3/8"
S264PMT-8	1/2"
S264PMT-10	5/8"
S264PMT-12	3/4"

[E] FEMALE BRANCH TEE

P/N	TUBE	PIPE
S977PMTNS-4	1/4"	1/8"
S977PMTNS-4-4	1/4"	1/4"
S977PMTNS-6	3/8"	1/4"
S977PMTNS-6-6	3/8"	3/8"

[F] FEMALE BRANCH TEE - SWIVEL

P/N	TUBE	PIPE
S977PMT-4	1/4"	1/8"
S977PMT-4-4	1/4"	1/4"
S977PMT-6	3/8"	1/4"



COMPOSITE DOT PUSH-TO-CONNECT AIR BRAKE FITTINGS

PRODUCT FEATURES

- Designed to Resist Mechanical Pull-Out
- Easy to Assemble and Disassemble Over and Over Again
- Swivel is for Installation Purposes Only

APPLICATIONS

Use with SAE J844 Nylon Air Brake Tubing

WORKING PRESSURE

Up to 145 PSI

TEMPERATURE RANGE

-40°F to 140°F
(-40°C to 60°C)

STANDARD COMPLIANCE

Meets DOT FMVSS 571.106 Standards and SAE J1131, J2494-1, J2494-3

ASSEMBLY INSTRUCTIONS

1. Cut Tubing Squarely (Maximum 15° Angle)
2. Check that the Port of the Mating Part is Clean and Free of Debris
3. Insert Tubing into Fitting Until it Bottoms (Push at Least Twice to Verify that Tubing is Inserted Past Collar and O-Ring)
4. Pull on Tubing to Verify it is Fully Inserted
5. To Disassemble, Simply Press the Release Collar, Holding it Against the Fitting Body & Simultaneously Pull Tubing Out of Fitting

[A] UNION

P/N	TUBES
S762PMT-2*	1/8"
S762PMT-532	5/32"
S762PMT-532-4	5/32" & 1/4"
S762PMT-3*	3/16"
S762PMT-4	1/4"
S762PMT-6	3/8"
S762PMT-6-8	3/8" & 1/2"
S762PMT-8	1/2"
S762PMT-10	5/8"
S762PMT-12-12	3/4"

* Non-DOT

[B] BULKHEAD UNION

P/N	TUBE	STRAIGHT
S762PMTBH-2*	1/8"	1/2"-20
S762PMTBH-5/32-5/32	5/32"	1/2"-20
S762PMTBH-4	1/4"	9/16"-18
S762PMTBH-6	3/8"	7/8"-14
S762PMTBH-8	1/2"	1"-12
S762PMTBH-10	5/8"	1-1/8"-12

* Non-DOT

[C] BULKHEAD FEMALE CONNECTOR

P/N	TUBE	PIPE	STRAIGHT
S786PMTBH-4-2	1/4"	1/8"	9/16"-18
S786PMTBH-4-4	1/4"	1/4"	9/16"-18
S786PMTBH-6-4	3/8"	1/4"	7/8"-14
S786PMTBH-6-6	3/8"	3/8"	7/8"-14
S786PMTBH-8-6	1/2"	3/8"	1"-12
S786PMTBH-8-8	1/2"	1/2"	1"-12

COMPOSITE PUSH-IN FITTINGS

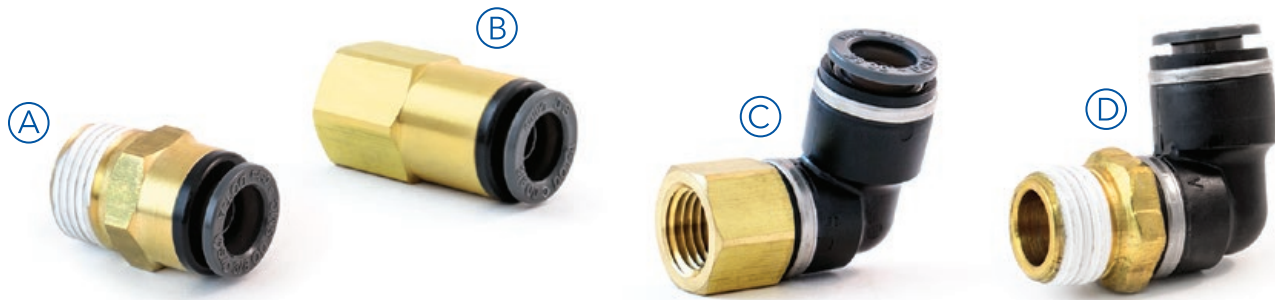

[A] MALE CONNECTOR

P/N	TUBE	PIPE
S768PMT-2-1*	1/8"	1/16"
S768PMT-2-2*	1/8"	1/8"
S768PMT-2-4*	1/8"	1/4"
S768PMT-532-1	5/32"	1/16"
S768PMT-532-2	5/32"	1/8"
S768PMT-532-4	5/32"	1/4"
S768PMT-4-2	1/4"	1/8"
S768PMT-4-4	1/4"	1/4"
S768PMT-4-6	1/4"	3/8"
S768PMT-6-2	3/8"	1/8"
S768PMT-6-4	3/8"	1/4"
S768PMT-6-6	3/8"	3/8"
S768PMT-6-8	3/8"	1/2"
S768PMT-8-4	1/2"	1/4"
S768PMT-8-6	1/2"	3/8"
S768PMT-8-8	1/2"	1/2"
S768PMT-10-6	5/8"	3/8"
S768PMT-10-8	5/8"	1/2"
S768PMT-12-6	3/4"	3/8"
S768PMT-12-8	3/4"	1/2"
S768PMT-12-12	3/4"	3/4"

* Non-DOT

[C] FEMALE ELBOW

Repositionable

P/N	TUBE	PIPE
S770PMT-5/32-2	5/32"	1/8"
S770PMT-4-2	1/4"	1/8"
S770PMT-4-4	1/4"	1/4"
S770PMT-4-6	1/4"	3/8"
S770PMT-6-2	3/8"	1/8"
S770PMT-6-4	3/8"	1/4"
S770PMT-6-6	3/8"	3/8"
S770PMT-6-8	3/8"	1/2"
S770PMT-8-4	1/2"	1/4"
S770PMT-8-6	1/2"	3/8"
S770PMT-8-8	1/2"	1/2"

[B] FEMALE CONNECTOR

P/N	TUBE	PIPE
S766PMT-532-2	5/32"	1/8"
S766PMT-4-2	1/4"	1/8"
S766PMT-4-4	1/4"	1/4"
S766PMT-4-6	1/4"	3/8"
S766PMT-6-2	3/8"	1/8"
S766PMT-6-4	3/8"	1/4"
S766PMT-6-6	3/8"	3/8"
S766PMT-6-8	3/8"	1/2"
S766PMT-8-2	1/2"	1/8"
S766PMT-8-4	1/2"	1/4"
S766PMT-8-6	1/2"	3/8"
S766PMT-8-8	1/2"	1/2"

[D] MALE ELBOW

Repositionable

* Non-DOT

P/N	TUBE	PIPE
S769PMT-532-2	5/32"	1/8"
S769PMT-532-4	5/32"	1/4"
S769PMT-2-2*	1/8"	1/8"
S769PMT-2-4*	1/8"	1/4"
S769PMT-4-2	1/4"	1/8"
S769PMT-4-4	1/4"	1/4"
S769PMT-4-6	1/4"	3/8"
S769PMT-6-2	3/8"	1/8"
S769PMT-6-4	3/8"	1/4"
S769PMT-6-6	3/8"	3/8"
S769PMT-6-8	3/8"	1/2"
S769PMT-8-4	1/2"	1/4"
S769PMT-8-6	1/2"	3/8"
S769PMT-8-8	1/2"	1/2"
S769PMT-10-6	5/8"	3/8"
S769PMT-10-8	5/8"	1/2"
S769PMT-10-12	5/8"	3/4"
S769PMT-12-8	3/4"	1/2"
S769PMT-12-12	3/4"	3/4"



[E] UNION ELBOW

P/N	TUBE
S765PMT-5/32	5/32"
S765PMT-4	1/4"
S765PMT-6	3/8"
S765PMT-8	1/2"

[G] UNION "Y"

P/N	TUBES
S764YPMT-4	1/4"
S764YPMT-4-4-6	1/4", 1/4", 3/8"
S764YPMT-6	3/8"
S764YPMT-6-6-4	3/8", 3/8", 1/4"

[F] 45° MALE ELBOW

Repositionable

P/N	TUBE	PIPE
S754PMT-2-2*	1/8"	1/8"
S754PMT-532-2	5/32"	1/8"
S754PMT-4-2	1/4"	1/8"
S754PMT-4-4	1/4"	1/4"
S754PMT-4-6	1/4"	3/8"
S754PMT-6-2	3/8"	1/8"
S754PMT-6-4	3/8"	1/4"
S754PMT-6-6	3/8"	3/8"
S754PMT-6-8	3/8"	1/2"
S754PMT-8-4	1/2"	1/4"
S754PMT-8-6	1/2"	3/8"
S754PMT-8-8	1/2"	1/2"
S754PMT-10-6	5/8"	3/8"
S754PMT-10-8	5/8"	1/2"
S754PMT-12-6	3/4"	3/8"
S754PMT-12-8	3/4"	1/2"

* Non-DOT

[H] MALE BRANCH "Y"

Repositionable

P/N	TUBES	THREAD
S798YPMT-4-2	1/4"	1/8"
S798YPMT-4-4	1/4"	1/4"
S798YPMT-6-4	3/8"	1/4"

[I] UNION TEE

P/N	TUBES
S764PMT-2*	1/8"
S764PMT-532	5/32"
S764PMT-3*	3/16"
S764PMT-4	1/4"
S764PMT-4-4-6	1/4", 1/4", 3/8"
S764PMT-6	3/8"
S764PMT-6-6-4	3/8", 3/8", 1/4"
S764PMT-8	1/2"
S764PMT-8-8-6	1/2", 1/2", 3/8"
S764PMT-10	5/8"

* Non-DOT

COMPOSITE PUSH-IN FITTINGS



[A] MALE BRANCH TEE
Repositionable

P/N	TUBE	PIPE
S772PMT-532-1	5/32"	1/16"
S772PMT-532-2	5/32"	1/8"
S772PMT-532-4	5/32"	1/4"
S772PMT-2-2*	1/8"	1/8"
S772PMT-2-4*	1/8"	1/4"
S772PMT-4-2	1/4"	1/8"
S772PMT-4-4	1/4"	1/4"
S772PMT-4-6	1/4"	3/8"
S772PMT-6-2	3/8"	1/8"
S772PMT-6-4	3/8"	1/4"
S772PMT-6-6	3/8"	3/8"
S772PMT-6-8	3/8"	1/2"
S772PMT-8-4	1/2"	1/4"
S772PMT-8-6	1/2"	3/8"
S772PMT-8-8	1/2"	1/2"
S772PMT-10-6	5/8"	3/8"
S772PMT-10-8	5/8"	1/2"

* Non-DOT

[B] FEMALE BRANCH TEE
Repositionable

P/N	TUBES	THREAD
S777PMT-4-2	1/4"	1/8"
S777PMT-4	1/4"	1/4"
S777PMT-6-4	3/8"	1/4"
S777PMT-8-6	1/2"	3/8"
S777PMT-10-4	5/8"	1/4"

[D] REDUCER ADAPTER

P/N	TUBES
37SP-4-6	1/4" & 3/8"
37SP-6-4	3/8" & 1/4"

[C] MALE RUN TEE
Repositionable

P/N	TUBE	PIPE
S771PMT-5/32-1	5/32"	1/16"
S771PMT-532-2	5/32"	1/8"
S771PMT-532-4	5/32"	1/4"
S771PMT-4-2	1/4"	1/8"
S771PMT-4-4	1/4"	1/4"
S771PMT-4-6-4	1/4" & 3/8"	1/4"
S771PMT-6-4	3/8"	1/4"
S771PMT-6-6	3/8"	3/8"
S771PMT-6-8	3/8"	1/2"
S771PMT-8-4	1/2"	1/4"
S771PMT-8-4-8	1/2" & 1/4"	1/2"
S771PMT-8-6	1/2"	3/8"
S771PMT-8-8	1/2"	1/2"

[E] PLUG-IN RUN TEE

P/N	TUBES
371SP-4-4	1/4"
371SP-4-6	1/4" & 3/8"
371SP-6-4-6	3/8", 1/4", 3/8"
371SP-6-6	3/8"
371SP-8-4-8	1/2", 1/4", 1/2"

[F] STANDPIPE ELBOW

P/N	TUBES
369SP-4-4	1/4"
369SP-4-6	1/4" & 3/8"
369SP-6-4	3/8" & 1/4"
369SP-6-6	3/8"
369SP-6-8	3/8" & 1/2"
369SP-8-8	1/2"



RUBBER AIR BRAKE HOSE FITTINGS

FEATURES

- Easy to Put Together with Many Different Types of Hose End Configurations
- Made of Brass to Help to Resist Corrosion

APPLICATIONS

For Use with SAE J1402 Type "A" Air Brake Hose in Making Hose Assemblies

WORKING PRESSURE

Up to 225 PSI

TEMPERATURE RANGE

-40°F to 212°F (-40°C to 100°C)

STANDARD COMPLIANCE

Air Brake Hose Ends will Meet DOT FMVSS 571.106 Standards when Used with SAE J1402 Type A Air Hose

ASSEMBLY INSTRUCTIONS

1. Slide Nut onto Hose
2. Slide Sleeve onto Hose with the Tapered Edge Toward Fitting Body
3. Firmly Bottom the Hose into Fittings
4. Screw Nut onto Body Until it Contacts the Fitting Body's Hex

NOTE: When putting together fitting, the body and nut should be inspected. They should only be reused if in proper condition. Never reuse sleeves.

[A] HOSE SLEEVE

P/N	HOSE
S360AB-6	3/8"
S360AB-8	1/2"

[B] HOSE NUT

P/N	HOSE
S361AB-6	3/8"
S361AB-8	1/2"

[C] HOSE NUT FOR SPRING GUARD

P/N	HOSE
S361ABS-6	3/8"
S361ABS-8	1/2"

[D] NUT WITH SPRING GUARD

P/N	HOSE
S371ABS-6	3/8"
S371ABS-8	1/2"

[E] SPRING GUARD

P/N	HOSE
S371AS-6	3/8"
S371AS-8	1/2"



[F] UNION BODY

P/N	HOSE
B362RB-6	3/8"
B362RB-8	1/2"

[G] UNION

P/N	HOSE
S362RB-6	3/8"
S362RB-8	1/2"

[H] MALE CONNECTOR BODY

P/N	HOSE	PIPE
S368AB-6-4-1	3/8"	1/4"
S368AB-6-6-1	3/8"	3/8"
S368AB-6-8-1	3/8"	1/2"
S368AB-8-6-1	1/2"	3/8"
S368AB-8-8-1	1/2"	1/2"

[I] MALE CONNECTOR

P/N	HOSE	PIPE
S368AB-6-4	3/8"	1/4"
S368AB-6-6	3/8"	3/8"
S368AB-6-8	3/8"	1/2"
S368AB-8-6	1/2"	3/8"
S368AB-8-8	1/2"	1/2"

[J] MALE CONNECTOR WITH SPRING

P/N	HOSE	PIPE
S378AB-6-4	3/8"	1/4"
S378AB-6-6	3/8"	3/8"
S378AB-6-8	3/8"	1/2"
S378AB-8-6	1/2"	3/8"
S378AB-8-8	1/2"	1/2"



[A] FEMALE SWIVEL BODY

P/N	HOSE	STRAIGHT THREAD
B366RBSV-634	3/8"	3/4"-20
B366RBSV-878	1/2"	7/8"-20

[B] FEMALE SWIVEL

P/N	HOSE
S366RBSV-634	3/8"
S366RBSV-878	1/2"

[C] FEMALE SWIVEL WITH ADAPTER

P/N	HOSE	PIPE	STRAIGHT
S363RB-6-4	3/8"	1/4"	3/4"-20
S363RB-6	3/8"	3/8"	3/4"-20
S363RB-6-8	3/8"	1/2"	3/4"-20
S363RB-8-6	1/2"	3/8"	7/8"-20
S363RB-8	1/2"	1/2"	7/8"-20

[D] FEMALE SWIVEL - ADAPTER & SPRING

P/N	HOSE	PIPE	STRAIGHT
S363RB-6-4S	3/8"	1/4"	3/4"-20
S363RB-6-8S	3/8"	3/8"	3/4"-20

[E] ADAPTER

P/N	HOSE	PIPE	STRAIGHT
S376AB-3/4-4	3/8"	1/4"	3/4"-20
S376AB-3/4-6	3/8"	3/8"	3/4"-20
S376AB-3/4-8	3/8"	1/2"	3/4"-20
S376AB-7/8-6	1/2"	3/8"	7/8"-20
S376AB-7/8-8	1/2"	1/2"	7/8"-20

NOTE: Use an Adapter with 3/4"-20 Straight Threads for Replacement in Tramec Sloan Adapter Style Air Brake Hose Assemblies (Pages 34-35)

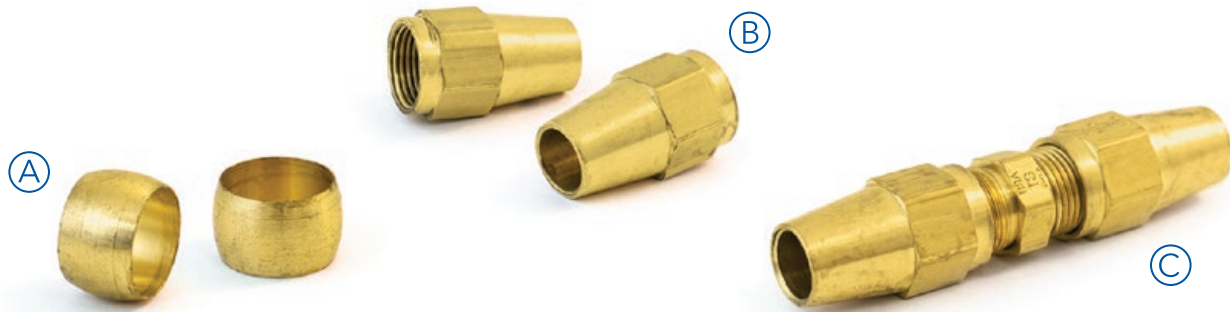

COPPER AIR BRAKE TUBE FITTINGS

PRODUCT APPLICATIONS

- For Use with Copper Tubing that Meets SAE J1149 in Air Brake Systems
- Air Brake Bodies (with Addition of NTA Nut, Sleeve, and Insert) are Interchangeable with the Bodies Used on SAE J844 Nylon Tube Air Brake Fittings

WORKING PRESSURE

Up to 150 PSI

TEMPERATURE RANGE

-65°F to 250°F (-54°C to 121°C)

STANDARD COMPLIANCE

Meets SAE J246

ASSEMBLY INSTRUCTIONS

1. Cut Tubing Squarely and Remove Burrs
2. Slide Nut, then Sleeve, onto Tubing
3. Insert Tubing into Fitting Until it Bottoms
4. Screw Down Nut to Finger Tight
5. Wrench-Tighten up to 3 Turns, Depending on Size. Smaller Sizes Require Fewer Tightening Turns

NOTE: Dimensions and Configurations are Subject to Change without Notice.

[A] COPPER TUBE SLEEVE

P/N	TUBE
S260AB-4	1/4"
S260AB-6	3/8"
S260AB-8	1/2"
S260AB-10	5/8"
S260AB-12	3/4"

[B] COPPER TUBE NUT

P/N	TUBE
S261AB-4	1/4"
S261AB-6	3/8"
S261AB-8	1/2"
S261AB-10	5/8"
S261AB-12	3/4"

[C] UNION

P/N	TUBE
S262AB-4	1/4"
S262AB-6	3/8"
S262AB-8	1/2"
S262AB-10	5/8"
S262AB-12	3/4"



[A] MALE CONNECTOR

P/N	TUBE	PIPE
S268AB-4-2	1/4"	1/8"
S268AB-4-4	1/4"	1/4"
S268AB-4-6	1/4"	3/8"
S268AB-6-2	3/8"	1/8"
S268AB-6-4	3/8"	1/4"
S268AB-6-6	3/8"	3/8"
S268AB-6-8	3/8"	1/2"
S268AB-8-4	1/2"	1/4"
S268AB-8-6	1/2"	3/8"
S268AB-8-8	1/2"	1/2"
S268AB-10-6	5/8"	3/8"
S268AB-10-8	5/8"	1/2"
S268AB-10-12	5/8"	3/4"
S268AB-12-8	3/4"	1/2"
S268AB-12-12	3/4"	3/4"

[B] FEMALE CONNECTOR

P/N	TUBE	PIPE
S266AB-4-2	1/4"	1/8"
S266AB-4-4	1/4"	1/4"
S266AB-6-2	3/8"	1/8"
S266AB-6-4	3/8"	1/4"
S266AB-6-6	3/8"	3/8"
S266AB-8-6	1/2"	3/8"
S266AB-8-8	1/2"	1/2"
S266AB-10-6	5/8"	3/8"
S266AB-10-10	5/8"	5/8"

[C] 45° ELBOW

P/N	TUBE	PIPE
S279AB-4-2	1/4"	1/8"
S279AB-4-4	1/4"	1/4"
S279AB-6-2	3/8"	1/8"
S279AB-6-4	3/8"	1/4"
S279AB-6-6	3/8"	3/8"
S279AB-6-8	3/8"	1/2"
S279AB-8-6	1/2"	3/8"
S279AB-8-8	1/2"	1/2"
S279AB-10-8	5/8"	5/8"

[D] MALE ELBOW

P/N	TUBE	PIPE
S269AB-4-2	1/4"	1/8"
S269AB-4-4	1/4"	1/4"
S269AB-4-6	1/4"	3/8"
S269AB-6-2	3/8"	1/8"
S269AB-6-4	3/8"	1/4"
S269AB-6-6	3/8"	3/8"
S269AB-6-8	3/8"	1/2"
S269AB-8-4	1/2"	1/4"
S269AB-8-6	1/2"	3/8"
S269AB-8-8	1/2"	1/2"
S269AB-10-6	5/8"	3/8"
S269AB-10-8	5/8"	1/2"
S269AB-10-12	5/8"	3/4"
S269AB-12-8	3/4"	1/2"

COPPER TUBE FITTINGS



[E] FEMALE ELBOW

P/N	TUBE	PIPE
S270AB-4-2	1/4"	1/8"
S270AB-4-4	1/4"	1/4"
S270AB-6-2	3/8"	1/8"
S270AB-6-4	3/8"	1/4"
S270AB-6-6	3/8"	3/8"
S270AB-8-6	1/2"	3/8"
S270AB-8-8	1/2"	1/2"
S270AB-10-8	5/8"	1/2"

[H] MALE RUN TEE

P/N	TUBES	PIPE
S271AB-4-2-4	1/4" & 1/8"	1/4"
S271AB-4-4	1/4"	1/4"
S271AB-6-4	3/8" & 1/4"	3/8"
S271AB-6-6	3/8"	3/8"
S271AB-8-6	1/2" & 3/8"	1/2"
S271AB-8-4	1/2"	1/4"
S271AB-8-6-6	1/2" & 3/8"	3/8"
S271AB-8-8	1/2"	1/2"
S271AB-10-8	5/8" & 1/2"	5/8"

[F] UNION ELBOW

P/N	TUBE
S265AB-4	1/4"
S265AB-6	3/8"
S265AB-8	1/2"
S265AB-10	5/8"

[I] MALE BRANCH TEE

P/N	TUBES	PIPE
S272AB-4-2	1/4"	1/8"
S272AB-4-4	1/4"	1/4"
S272AB-6-2	3/8" & 1/8"	3/8"
S272AB-6-4	3/8"	1/4"
S272AB-6-6	3/8"	3/8"
S272AB-8-6	1/2"	3/8"
S272AB-8-8	1/2"	1/2"
S272AB-10-8	5/8" & 1/2"	5/8"

[G] UNION TEE

P/N	TUBE
S264AB-4	1/4"
S264AB-6	3/8"
S264AB-8	1/2"
S264AB-10	5/8"

BULKHEAD FITTINGS

APPLICATION

Use to Connect a Tube or Hose Through a Wall or Other Barrier

OTHER INDUSTRY TERMS

- Terminal Bolts
- Anchor Fittings
- Frame Coupling
- Clamping Studs

ASSEMBLY INSTRUCTIONS

1. Remove Jam & Washer Nut if Assembled
2. Insert Bulkhead Through Wall/Barrier
3. Finger Tighten, then Completely Secure Nut with Wrench



55207



55607



55611



55616



55661



55807

P/N	BODY	FEMALE PIPE	BODY THREAD	BODY HEX	LENGTH	MAX GRIP LENGTH	WASHER	NUT
55207	Brass	1/8"-27 NPTF	5/8"-18 UNF	7/8"	1-1/2"	0.9"	Steel*	Brass*
55607	Brass	3/8"-18 NPTF	1"-14 UNS	1-1/8"	1-5/16"	0.47"	LW100	JN114W
55607-BN	Brass	3/8"-18 NPTF	1"-14 UNS	1-1/8"	1-5/16"	0.65"	LW100	207-6
55607STL	Steel	3/8"-18 NPTF	1"-14 UNS	1-1/8"	1-5/16"	0.47"	LW100	JN114W
55611	Brass	1/4"-18 NPTF	3/4"-16 UNF	1"	15/16"	0.28"	LW340	207-4
55611-SN	Brass	1/4"-18 NPTF	3/4"-16 UNF	1"	15/16"	0.24"	LW340	JN3416W
55611STL	Steel	1/4"-18 NPTF	3/4"-16 UNF	1"	15/16"	0.39"	LW340	JN3416W
55616	Brass	3/8"-18 NPTF	7/8"-20 UNEF	1-1/8"	2- 3/8"	0.465"	LW100	207-6
55661	Brass	1/4"-18 NPTF	3/4"-16 UNF	1"	1-1/2"	0.8"	LW340	JN3416W
55661-BN	Brass	1/4"-18 NPTF	3/4"-16 UNF	1"	1-1/2"	0.84"	LW340	207-4
55661STL	Steel	1/4"-18 NPTF	3/4"-16 UNF	1"	1-1/2"	0.8"	LW340	JN3416W
55807	Brass	1/2"-14 NPTF	1-1/8"-14 UNS	1-1/4"	1-1/2"	0.84"	LW100	207-5

BULKHEAD FITTINGS

CLAMPING STUDS

- Body Thread: 1"-14 UNS
- Body Hex: 1-1/4"
- Male Pipe: 1/2"-14 NPTF
- Washer: LW100 (Steel)



55600



55613



55615



55620



55629



55646



55664

P/N	BODY	FEMALE PIPE	LENGTH	MAX GRIP LENGTH	NUT
55600	Brass	1/4"-18 NPTF	2-7/8"	.535"	JN114W (Steel)
55600-BN	Brass	1/4"-18 NPTF	2-7/8"	.715"	207-6 (Brass)
55600STL	Steel	1/4"-18 NPTF	2-7/8"	.535"	JN114W (Steel)
55613	Brass	3/8"-18 NPTF	1-7/8"	0.29"	JN114W (Steel)
55613-BN	Steel	3/8"-18 NPTF	1-7/8"	0.47"	207-6 (Brass)
55615	Brass	1/4"-18 NPTF	1-29/32"	0.31"	JN114W (Steel)
55615-BN	Brass	1/4"-18 NPTF	1-29/32"	0.49"	207-6 (Brass)
55620	Brass	3/8"-18 NPTF	1-11/16"	0.28"	207-6 (Brass)
55620-SN6	Brass	3/8"-18 NPTF	1-11/16"	0.4"	207-6STL (Steel)
55620STL	Steel	3/8"-18 NPTF	1-11/16"	0.1"	JN114W (Steel)
55629	Brass	1/2"-14 NPTF	2-3/8"	.285"	JN114W (Steel)
55629-BN	Brass	1/2"-14 NPTF	2-3/8"	.465"	207-6 (Brass)
55646	Brass	3/8"-18 NPTF	1-29/32"	0.31"	JN114W (Steel)
55646-BN	Brass	3/8"-18 NPTF	1-29/32"	0.49"	207-6 (Brass)
55646STL	Steel	3/8"-18 NPTF	1-29/32"	0.31"	JN114W (Steel)
55664	Steel	1/4"-18 NPTF	3-15/16"	1.597"	JN114W (Steel)

ONE-PIECE TERMINAL BOLT

- **New!** One-Piece, All-Brass Design for a More Economical Solution
- Eliminates Multiple Air Connections and Thus One More Point of Failure/Leakage
- Provides Ease of Installation



55404

P/N	THREAD	NTA TUBE	LENGTH	BODY THREAD	BODY HEX	NUT
55404	Female: 1/4"-18 NPTF	1/4" O.D.	1.27"	3/4"-16 UNF	1"	207-4
55816	Male: 1/2"-14 NPTF	3/8" O.D.	2.35"	1"-14 UNS	1-1/4"	JN114W
55818	Male: 1/2"-14 NPTF	1/2" O.D.	2.44"	1"-14 UNS	1-1/4"	JN114W

ANCHOR FITTINGS FOR TUBING

- Female Pipe: 3/8"-18 NPTF
- Body Thread: 7/8"-20 UNEF
- Body Hex: 1-1/6"
- Max Grip Length: .305"
- Washer: LW780 (Steel)



P/N	BODY	NTA TUBE	LENGTH	NUT
50008	Brass	1/2" O.D.	1-3/8"	5000082
50009	Brass	3/8" O.D.	1-3/8"	5000082
55608	Brass	1/2" O.D.	1-15/16"	JN7820
55609	Brass	3/8" O.D.	1-3/4"	JN7820
S608	Brass	1/2" O.D.	1-5/16"	ND7820YL
S609	Brass	3/8" O.D.	1-3/8"	ND7820YL
S646-S768AB-6-6	Brass	3/8" O.D.	3-3/8"	NE114WCL

CLAMPING STUDS

- Body Thread: 3/4"-16 UNF
- Body Hex: 1-1/4"
- Male Pipe: 1/2"-14 NPTF
- Female Pipe: 1/4"-18 NPTF
- Washer: LW100 (Steel)
- Nut: JN3416W (Steel)



55612STL



55689STL

P/N	BODY	LENGTH	MAX GRIP LENGTH
55612STL	Steel	1-11/16"	.24
55689STL	Steel	2-5/32"	.07

TERMINAL BOLTS



S600



S612



S629



S646

P/N	BODY	FEMALE PIPE	BODY THREAD	MALE PIPE	LENGTH	WASHER	NUT
S600	Brass	1/4"-18 NPTF	1"-14 UNS	1/2"-14 NPTF	2-7/8"	LW100	NE114WCL
S600L	Brass	1/4"-18 NPTF	1"-14 UNS	1/2"-14 NPTF	2-7/8"	LW100	207-6HDSTL
S607	Brass	3/8"-18 NPTF	1"-14 UNS	3/8"-18 NPTF	1-5/16"	LW100	NE114WCL
S612	Steel	1/4"-18 NPTF	3/4"-16 UNS	1/2"-14 NPTF	1-11/16"	LW340	NC3416CL
S613	Brass	1/2"-14 NPTF	1"-14 UNS	3/8"-18 NPTF	1-7/8"	LW100	NE114WCL
S629	Brass	1/2"-14 NPTF	1"-14 UNS	1/2"-14 NPTF	2-3/8"	LW100	NE114WCL
S646	Brass	3/8"-18 NPTF	1"-14 UNS	1/2"-14 NPTF	1-29/32"	LW100	NE114WCL

LOCK WASHERS

P/N	MATERIAL	I.D.
LW340	Steel	3/4"
LW780	Steel	7/8"
LW100	Steel	1"
LW1125	Steel	1-1/8"



JAM NUTS/PANEL NUTS



207-4



207-6



JN114W

P/N	MATERIAL	WIDTH	HEX	THREAD
207-4	Brass	.37"	1.100"	3/4"-16 UNF
207-5	Brass	.28"	1.125"	1/8"-20 UNF
207-6	Brass	.38"	1.250"	1"-14 UNS
207-6HDSTL	Steel	.38"	1.375"	1"-14 UNS
207-6STL	Steel	.25"	1.250"	1"-14 UNS
207-8	Brass	.37"	1.375"	1-1/8"-14 UNS
JN114W	Steel	.55"	1.460"	1"-14 UNS
JN3416W	Steel	.41"	1.100"	3/4"-16 UNF
JN7820	Die Cast Zinc	.23"	1.125"	7/8"-20 UNEF
NC3416CL	Steel	.25"	1.125"	3/4"-16 UNF
ND7820YL	Steel	.25"	1.125"	7/8"-20 UNEF
NE114WCL	Steel	.375"	1.125"	1"-14 UNS

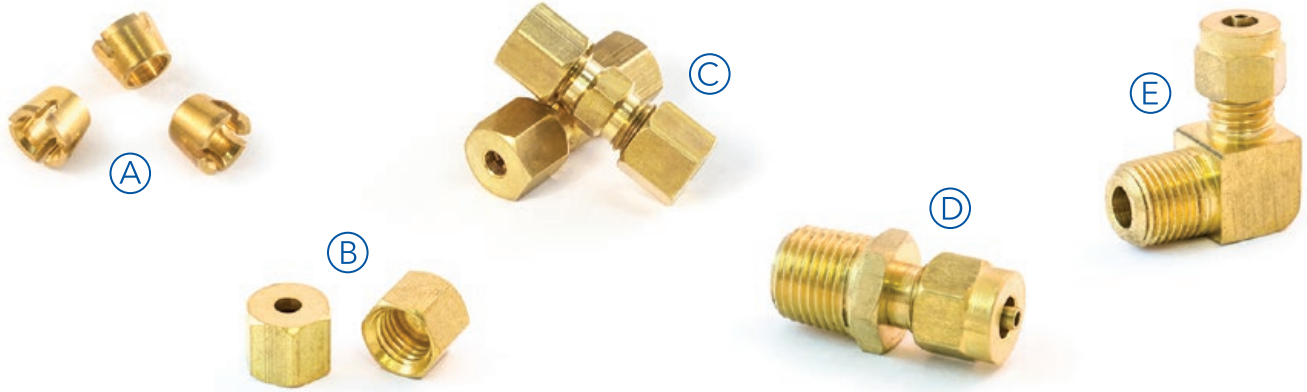

TRANSMISSION FITTINGS

FEATURES

Fittings Utilize a Specially Designed Slotted Sleeve to Help Prevent Notch Stress Related to Over-Torque.

APPLICATIONS

For Use with SAE J844 Type A Nylon Tubing in Pressure Protected Air Transmission Applications

WORKING PRESSURE

Up to 150 PSI

TEMPERATURE RANGE

-40°F to 220°F (-40°C to 104°C)

ASSEMBLY INSTRUCTIONS

1. Cut Tubing Squarely
2. Insert Tubing into Fitting until it Bottoms
3. Tighten Nut 1-1/2 Turns from Finger Tight

[A] TRANSMISSION SPLIT SLEEVE

P/N	TUBE
S60TF-2	1/8"
S60TF-5/32	5/32"

[B] TRANSMISSION NUT

P/N	TUBE
S61TF-2	1/8"
S61TF-5/32	5/32"

[C] TRANSMISSION UNION

P/N	TUBE
S62TF-2	1/8"
S62TF-5/32	5/32"

[D] TRANSMISSION MALE CONNECTOR

P/N	TUBE	PIPE
S68TF-2-1	1/8"	1/16"
S68TF-2-2	1/8"	1/8"
S68TF-5/32-1	5/32"	1/16"
S68TF-5/32-2	5/32"	1/8"

[E] TRANSMISSION MALE ELBOW

P/N	TUBE	PIPE
S69TF-2-1	1/8"	1/16"
S69TF-2-2	1/8"	1/8"
S69TF-5/32-2	5/32"	1/8"



BRASS PIPE FITTINGS

APPLICATIONS

- For Use with Brass, Copper, or Iron Pipe
- For Use in Water, Grease, Fuels, LP and Natural Gases, Refrigeration, Instrumentation and Hydraulic Systems
- Designed for Low and Medium Pressure Pipe Line Connections

TEMPERATURE RANGE

-65°F to 250°F (-54°C to 121°C)

ASSEMBLY INSTRUCTIONS

1. Tighten Approximately 1-1/2 Turns Past Hand Tight
2. Always Orient Shapes (Elbows, Tees, Etc.) by Turning Clockwise – Never by Backing the Fittings Out

NOTES:

- Light Pattern Fittings have Reduced Dimensions and Are Non-SAE
- As of January 1, 2014 Tramec Sloan is not Legal for Potable Water Applications, per Federal Reduction of Lead in Drinking Water Act of 2011

[A] PIPE LOCK NUT

P/N	PIPE
S210-2	1/8"
S210-4	1/4"
S210-6	3/8"
S210-8	1/2"

[B] SLOTTED PIPE PLUG

P/N	PIPE
S220P-2	1/8"
S220P-4	1/4"
S220P-6	3/8"

[C] PIPE CAP

P/N	PIPE
S213-2	1/8"
S213-4	1/4"
S213-6	3/8"
S213-8	1/2"
S213-12	3/4"

[D] HEX-HEAD PIPE PLUG

Hollow Core

P/N	PIPE
SPPH-2	1/8"
SPPH-4	1/4"
SPPH-6	3/8"
SPPH-8	1/2"
SPPH-12	3/4"

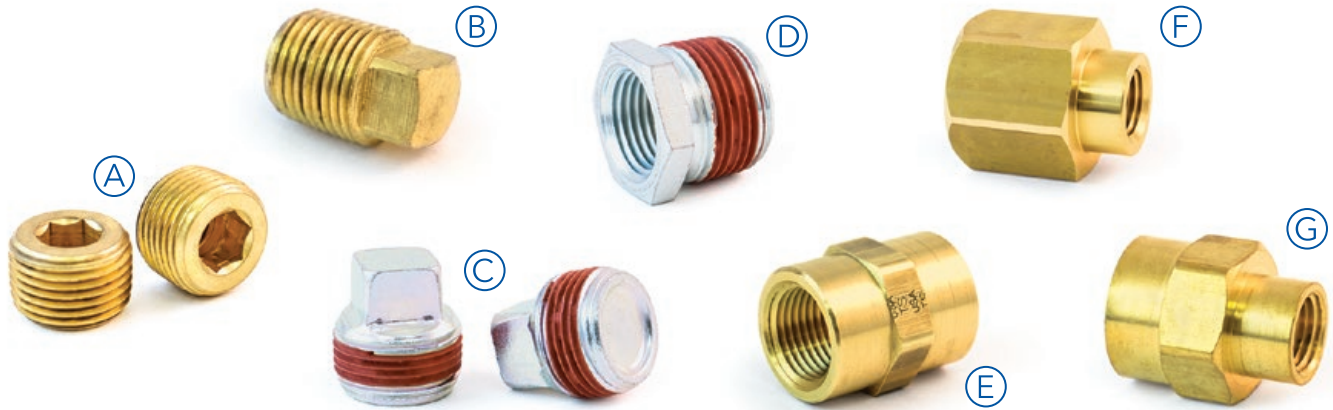

[A] HEX COUNTERSINK PIPE PLUG

P/N	PIPE
S219P-2	1/8"
S219P-4	1/4"
S219P-6	3/8"
S219P-8	1/2"
S219P-12	3/4"

[B] SQUARE-HEAD PIPE PLUG

P/N	PIPE
S211-2	1/8"
S211-4	1/4"
S211-6	3/8"
S211-8	1/2"
S211-12	3/4"
S211-16	1"

[C] STEEL SQUARE-HEAD PIPE PLUG

P/N	PIPE
73151-12STLV	3/4"

[D] STEEL PIPE REDUCER BUSHING

P/N	MALE PIPE	FEMALE PIPE
73220-12-8STLV	3/4"	1/2"

[E] FEMALE PIPE COUPLING

P/N	PIPES
S207-2	1/8"
S207-4	1/4"
S207-6	3/8"
S207-8	1/2"
S207-12	3/4"

[E] FEMALE PIPE COUPLING

Light Pattern - Non SAE

P/N	PIPES
63300-2	1/8"
63300-4	1/4"
63300-6	3/8"
63300-8	1/2"
63300-12	3/4"

[F] FEMALE PIPE REDUCER COUPLING

P/N	PIPES
S119-4-2	1/4" & 1/8"
S119-6-2	3/8" & 1/8"
S119-6-4	3/8" & 1/4"
S119-8-2	1/2" & 1/8"
S119-8-4	1/2" & 1/4"
S119-8-6	1/2" & 3/8"
S119-12-8	3/4" & 1/2"

[G] FEMALE PIPE REDUCER COUPLING

Light Pattern - Non SAE

P/N	PIPES
63300-4-2	1/4" & 1/8"
63300-6-4	3/8" & 1/4"
63300-8-2	1/2" & 1/8"
63300-8-4	1/2" & 1/4"
63300-8-6	1/2" & 3/8"

BRASS PIPE FITTINGS



[A] PIPE ADAPTER

P/N	FEMALE PIPE	MALE PIPE
S120-2	1/8"	1/8"
S120-4	1/4"	1/4"
S120-4-2	1/4"	1/8"
S120-6	3/8"	3/8"
S120-6-2	3/8"	1/8"
S120-6-4	3/8"	1/4"
S120-8	1/2"	1/2"
S120-8-4	1/2"	1/4"
S120-8-6	1/2"	3/8"
S120-12	3/4"	3/4"
S120-12-6	3/4"	3/8"
S120-12-8	3/4"	1/2"

[B] PIPE ADAPTER

Light Pattern - Non SAE

P/N	FEMALE PIPE	MALE PIPE
63200-2	1/8"	1/8"
63200-4	1/4"	1/4"
63200-4-2	1/4"	1/8"
63200-6	3/8"	3/8"
63200-6-2	3/8"	1/8"
63200-6-4	3/8"	1/4"
63200-8	1/2"	1/2"
63200-8-4	1/2"	1/4"
63200-8-6	1/2"	3/8"
63200-12-8	3/4"	1/2"

[C] PIPE REDUCER BUSHING

P/N	MALE PIPE	FEMALE PIPE
SPRB-4-2	1/4"	1/8"
SPRB-6-2	3/8"	1/8"
SPRB-6-4	3/8"	1/4"
SPRB-8-2	1/2"	1/8"
SPRB-8-4	1/2"	1/4"
SPRB-8-6	1/2"	3/8"
SPRB-12-2	3/4"	3/4"
SPRB-12-4	3/4"	1/4"
SPRB-12-6	3/4"	3/8"
SPRB-12-8	3/4"	1/2"
SPRB-16-12	1"	3/4"

[D] PIPE REDUCER BUSHING

Light Pattern - Non SAE

P/N	MALE PIPE	FEMALE PIPE
63220-8-2	1/2"	1/8"
63220-12-8	3/4"	1/2"
63220-16-12	1"	3/4"

[E] FEMALE PIPE UNION

P/N	PIPES
S104-2	1/8"
S104-4	1/4"
S104-6	3/8"
S104-8	1/2"
S104-12	3/4"

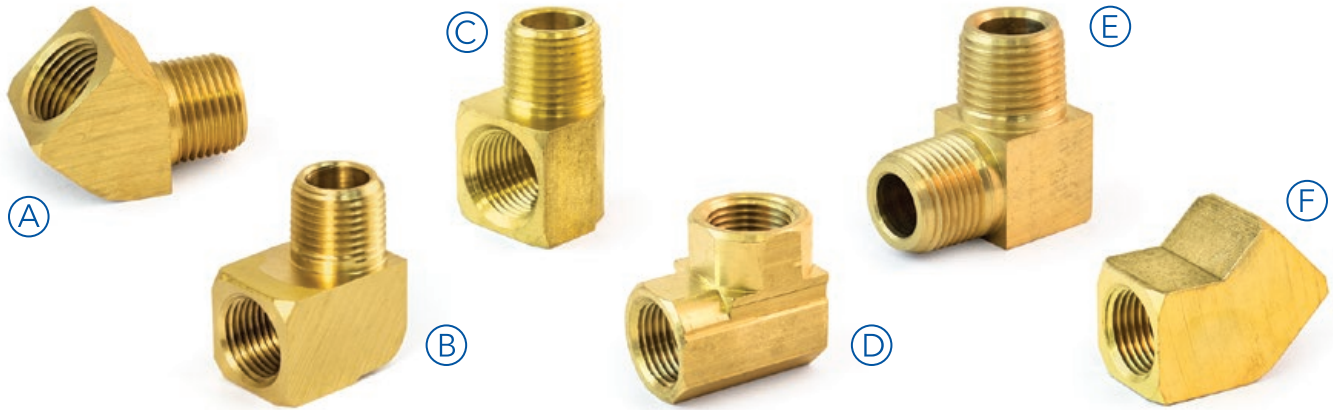

[A] 45° STREET ELBOW

P/N	PIPE
S224-2	1/8"
S224-4	1/4"
S224-6	3/8"
S224-8	1/2"
S224-12	3/4"

[D] 90° FEMALE PIPE ELBOW

P/N	PIPES
S200-2	1/8"
S200-4	1/4"
S200-6	3/8"
S200-8	1/2"
S200-12	3/4"

[B] 90° STREET ELBOW

P/N	FEMALE PIPE	MALE PIPE
S202-2	1/8"	1/8"
S202-4-2	1/4"	1/8"
S202-4	1/4"	1/4"
S202-6	3/8"	3/8"
S202-8-6	1/2"	3/8"
S202-8	1/2"	1/2"
S202-12	3/4"	3/4"

[E] 90° MALE PIPE ELBOW

P/N	PIPE
73455-2	1/8"
73455-4	1/4"
73455-6	3/8"
73455-6-4	3/8" & 1/4"
73455-8	1/2"

[C] 90° STREET ELBOW

Light Pattern - Non SAE

P/N	FEMALE PIPE	MALE PIPE
63400-2	1/8"	1/8"
63400-4-2	1/4"	1/8"
63400-4	1/4"	1/4"
63400-6	3/8"	3/8"
63400-8	1/2"	1/2"
63400-12	3/4"	3/4"

[F] 45° FEMALE PIPE ELBOW

P/N	PIPE
73355-2	1/8"
73355-4	1/4"
73355-6	3/8"
73355-8	1/2"
73355-12	3/4"

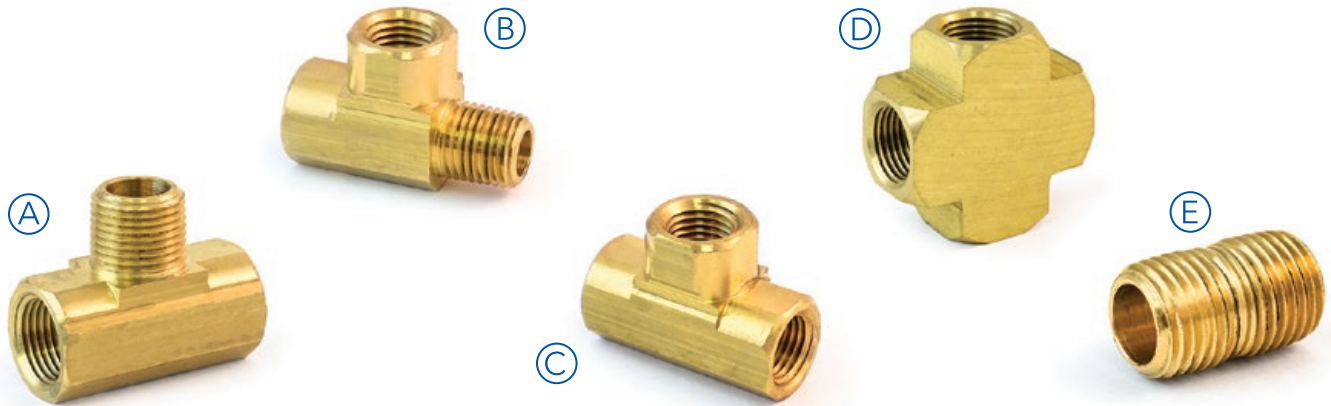

[A] MALE BRANCH TEE

P/N	FEMALE PIPE	MALE PIPE
S226-2	1/8"	1/8"
S226-4	1/4"	1/4"
S226-6	3/8"	3/8"
S226-8	1/2"	1/2"
S226-12	3/4"	3/4"

[D] FEMALE PIPE CROSS

P/N	PIPE
S102-2	1/8"
S102-4	1/4"
S102-6	3/8"
S102-8	1/2"
S102-12	3/4"

[B] PIPE STREET TEE

P/N	FEMALE PIPES	MALE PIPE
S225-2	1/8"	1/8"
S225-4	1/4"	1/4"
S225-6	3/8"	3/8"
S225-6-6-4	3/8" & 1/4"	3/8"
S225-8	1/2"	1/2"

[E] CLOSE PIPE NIPPLE

P/N	PIPE	TYPE
S215-2	1/8"	Yellow Brass
73326R-02	1/8"	Red Brass
S215-4	1/4"	Yellow Brass
73326R-04	1/4"	Red Brass
S215-6	3/8"	Yellow Brass
73326R-06	3/8"	Red Brass
S215-8	1/2"	Yellow Brass
73326R-08	1/2"	Red Brass
S215-12	3/4"	Yellow Brass
73326R-12	3/4"	Red Brass
73326R-16	1"	Red Brass
73326R-20	1-1/4"	Red Brass
73326R-24	1-1/2"	Red Brass
73326R-36	2"	Red Brass

[C] PIPE TEE

P/N	PIPE
S203-2	1/8"
S203-4	1/4"
S203-6	3/8"
S203-8	1/2"
S203-12	3/4"

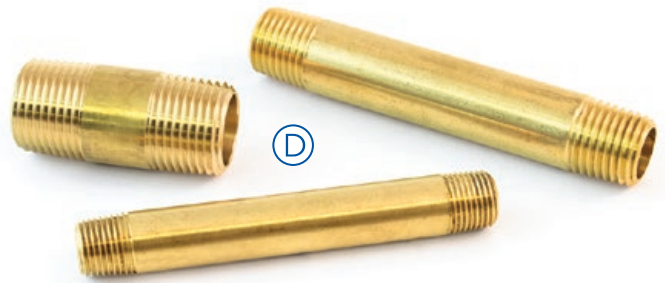
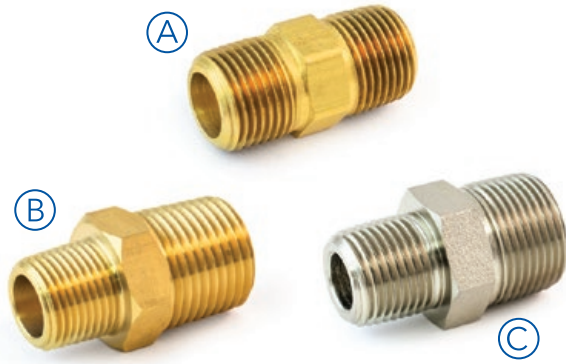

[A] BRASS HEX NIPPLE

Straight & Reducing

P/N	PIPES
SPHN-2	1/8"
SPHN-4-2	1/4" & 1/8"
SPHN-4	1/4"
SPHN-6-2	3/8" & 1/8"
SPHN-6-4	3/8" & 1/4"
SPHN-6	3/8"
SPHN-8-4	1/2" & 1/4"
SPHN-8-6	1/2" & 3/8"
SPHN-8	1/2"
SPHN-12-8	3/4" & 1/2"
SPHN-12	3/4"

[B] BRASS HEX NIPPLE

Straight & Reducing - Light Pattern - Non SAE

P/N	PIPES
63325-2	1/8"
63325-4-2	1/4" & 1/8"
63325-4	1/4"
63325-6-4	3/8" & 1/4"
63325-6	3/8"
63325-8-4	1/2" & 1/4"
63325-8-6	1/2" & 3/8"
63325-8	1/2"
63325-12-8	3/4" & 1/2"
63325-12	3/4"

[C] STEEL HEX NIPPLE

Straight & Reducing

P/N	PIPES
HPHN-6-4	3/8" & 1/4"
HPHN-8-6	1/2" & 3/8"
HPHN-8-8	1/2"
HPHN-12-12	3/4"
HPHN-12-8	3/4" & 1/2"

[D] LONG BRASS NIPPLE*

P/N	LENGTH	PIPE
S113-02-1.5-R	1-1/2"	1/8"
S113-04-1.5-R	1-1/2"	1/4"
S113-06-1.5-R	1-1/2"	3/8"
S113-08-1.5-R	1-1/2"	1/2"
S113-02-2-R	2"	1/8"
S113-04-2-R	2"	1/4"
S113-06-2-R	2"	3/8"
S113-08-2-YL	2"	1/2"
S113-12-2-R	2"	3/4"
S113-02-2.5-R	2-1/2"	1/8"
S113-04-2.5-R	2-1/2"	1/4"
S113-06-2.5-R	2-1/2"	3/8"
S113-08-2.5-R	2-1/2"	1/2"
S113-12-2.5-R	2-1/2"	3/4"
S113-02-3-R	3"	1/8"
S113-04-3-R	3"	1/4"
S113-06-3-R	3"	3/8"
S113-08-3-R	3"	1/2"
S113-02-3.5-R	3-1/2"	1/8"
S113-04-3.5-R	3-1/2"	1/4"
S113-06-3.5-R	3-1/2"	3/8"

* Also Available in Red Brass, Contact Us for More Information

45° BRASS FLARE FITTINGS

FEATURES

- Flare Fittings Resist Mechanical Pull Out
- Recommended for Higher Pressures than those Covered by Compression Fittings
- Made to be Assembled and Disassembled Over and Over Again
- Low Cost
- Reusable with a Long or Short Nut
- **Single vs. Double Flare:** Single Flares are Ordinarily Used to Connect Copper and Aluminum Tubing
- **Advantages of Double Flare:** Double Flare Removes the Possibility of Over Tightening

APPLICATIONS

For Use with Various Metallic Tubings

TEMPERATURE RANGE

-65°F to 250°F (-54°C to 121°C)

ASSEMBLY INSTRUCTIONS

1. Cut tubing Squarely and Clean Tube End Thoroughly to Remove Burrs
2. Place Nut onto Tube. Place Threaded End of Nut Toward End of Tube
3. Flare Tube End with Flaring Tool to Provide 45° Flare
4. Clamp Tube Flare Between Nut and Nose of Fitting Body by Screwing Nut on Finger-Tight
5. Tighten with a Wrench an Additional 1/4 to 1/2 Turn Past Finger Tight for a Metal to Metal Seal

CAUTION: Use of excessive torque may cause damage to the fitting and rupture the tubing at the flare.

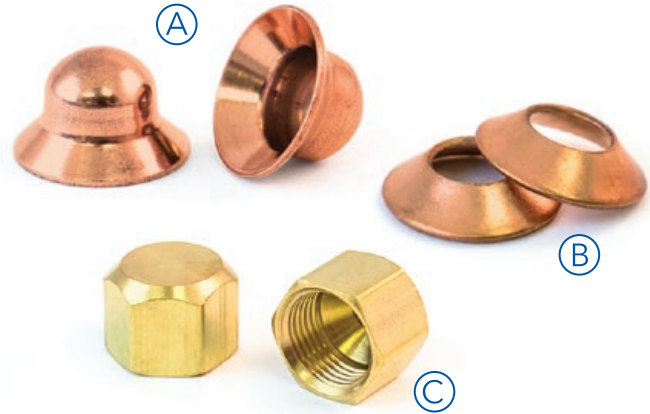

[A] FLARE BONNET

P/N	TUBE
SFB-6	3/8"
SFB-8	1/2"

[B] FLARE GASKET

P/N	TUBE
SFG-3	3/16"
SFG-4	1/4"
SFG-5	5/16"
SFG-6	3/8"
SFG-8	1/2"
SFG-10	5/8"
SFG-12	3/4"

[C] FLARE CAP

P/N	TUBE
S40-3	3/16"
S40-4	1/4"
S40-5	5/16"
S40-6	3/8"
S40-8	1/2"
S40-10	5/8"
S40-12	3/4"

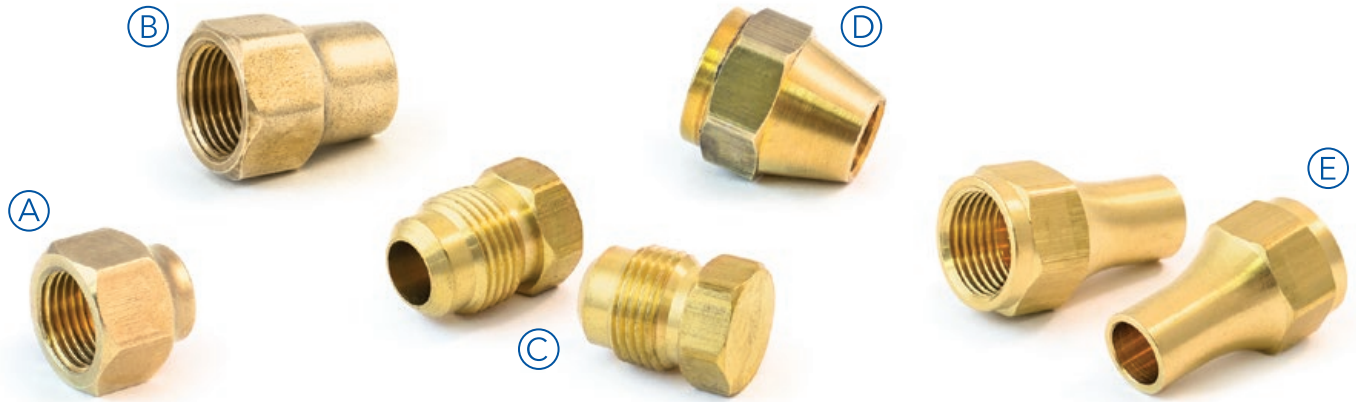

[A] SHORT FORGED REFRIGERATION NUT

P/N	TUBE	PIPE
S141S-3	3/16"	3/16"
S141S-4	1/4"	1/4"
S141S-5	5/16"	5/16"
S141S-6-4	3/8"	1/4"
S141S-6	3/8"	3/8"
S141S-8-6	1/2"	3/8"
S141S-8	1/2"	1/2"
S141S-10-8	5/8"	1/2"
S141S-10	5/8"	5/8"
S141S-12	3/4"	3/4"

[D] SHORT FLARE NUT

P/N	TUBE
S41S-2	1/8"
S41S-3	3/16"
S41S-4	1/4"
S41S-5	5/16"
S41S-6	3/8"
S41S-7	7/16"
S41S-8	1/2"
S41S-10	5/8"
S41S-12	3/4"
S41S-14	7/8"

[B] LONG FORGED REFRIGERATION NUT

P/N	TUBE
S141L-4	1/4"
S141L-6	3/8"
S141L-8	1/2"
S141L-10	5/8"

[E] LONG FLARE NUT

P/N	TUBE
S41L-4	1/4"
S41L-5	5/16"
S41L-6	3/8"
S41L-8	1/2"
S41L-10	5/8"

[C] FLARE PLUG

P/N	TUBE
S39-4	1/4"
S39-5	5/16"
S39-6	3/8"
S39-8	1/2"
S39-10	5/8"

45° FLARE FITTINGS



[F] FLARE UNION

Tube Both Ends

P/N	TUBES
S42-2	1/8"
S42-3	3/16"
S42-4	1/4"
S42-5	5/16"
S42-6-4	3/8" & 1/4"
S42-6-5	3/8" & 5/16"
S42-6	3/8"
S42-8-4	1/2" & 1/4"
S42-8-6	1/2" & 3/8"
S42-8	1/2"
S42-10-6	5/8" & 3/8"
S42-10-8	5/8" & 1/2"
S42-10	5/8"
S42-12-8	3/4" & 1/2"
S42-12	3/4"

[G] FORGED SWIVEL NUT VALVE CONNECTOR

P/N	TUBE
S114FSV-4	1/4"
S114FSV-5	5/16"
S114FSV-6	3/8"
S114FSV-8	1/2"
S114FSV-10	5/8"

[H] FLARE X MALE CONNECTOR

P/N	TUBE	PIPE
S48-2-2	1/8"	1/8"
S48-3-2	3/16"	1/8"
S48-4-2	1/4"	1/8"
S48-4-4	1/4"	1/4"
S48-4-6	1/4"	3/8"
S48-4-8	1/4"	1/2"
S48-5-2	5/16"	1/8"
S48-5-4	5/16"	1/4"
S48-5-6	5/16"	3/8"
S48-6-2	3/8"	1/8"
S48-6-4	3/8"	1/4"
S48-6-6	3/8"	3/8"
S48-6-8	3/8"	1/2"
S48-6-12	3/8"	3/4"
S48-8-4	1/2"	1/4"
S48-8-6	1/2"	3/8"
S48-8-8	1/2"	1/2"
S48-8-12	1/2"	3/4"
S48-10-4	5/8"	1/4"
S48-10-6	5/8"	3/8"
S48-10-8	5/8"	1/2"
S48-10-12	5/8"	3/4"
S48-12-8	3/4"	1/2"
S48-12-12	3/4"	3/4"
S48-14-12	7/8"	3/4"



[A] FLARE X FEMALE PIPE CONNECTOR

P/N	TUBE	PIPE
S46-3-2	3/16"	1/8"
S46-4-2	1/4"	1/8"
S46-4-4	1/4"	1/4"
S46-4-6	1/4"	3/8"
S46-4-8	1/4"	1/2"
S46-5-2	5/16"	1/8"
S46-5-4	5/16"	1/4"
S46-6-2	3/8"	1/8"
S46-6-4	3/8"	1/4"
S46-6-6	3/8"	3/8"
S46-6-8	3/8"	1/2"
S46-6-12	3/8"	3/4"
S46-8-4	1/2"	1/4"
S46-8-6	1/2"	3/8"
S46-8-8	1/2"	1/2"
S46-8-12	1/2"	3/4"
S46-10-6	5/8"	3/8"
S46-10-8	5/8"	1/2"
S46-10-12	5/8"	3/4"
S46-12-8	3/4"	1/2"
S46-12-12	3/4"	3/4"
S46-14-12	7/8"	3/4"

[B] FLARE ELBOW

Tube Both Ends

P/N	TUBE
S55-4	1/4"
S55-6	3/8"
S55-10	5/8"

[C] FLARE X FEMALE PIPE ELBOW

P/N	TUBE	PIPE
S50-6-6	3/8"	3/8"
S50-6-8	3/8"	1/2"
S50-8-8	1/2"	1/2"
S50-10-8	5/8"	1/2"

[D] FORGED 45° FLARE X MALE PIPE ELBOW

P/N	TUBE	PIPE
S159-4-2	1/4"	1/8"
S159-4-4	1/4"	1/4"
S159-6-4	3/8"	1/4"
S159-6-6	3/8"	3/8"
S159-8-6	1/2"	3/8"
S159-8-8	1/2"	1/2"
S159-10-6	5/8"	3/8"
S159-10-8	5/8"	1/2"

[E] FORGED FLARE ELBOW

Tube Both Ends

P/N	TUBES
S155-2	1/8"
S155-3	3/16"
S155-4	1/4"
S155-5	5/8"
S155-6-4	3/8" & 1/4"
S155-6	3/8"
S155-8-6	1/2" & 3/8"
S155-8	1/2"
S155-10-8	5/8" & 1/2"
S155-10	5/8"
S155-12	3/4"

45° FLARE FITTINGS



[F] FLARE X MALE PIPE ELBOW

P/N	TUBE	PIPE
S49-3-2	3/16"	1/8"
S49-4-2	1/4"	1/8"
S49-4-4	1/4"	1/4"
S49-4-6	1/4"	3/8"
S49-5-2	5/16"	1/8"
S49-5-4	5/16"	1/4"
S49-6-2	3/8"	1/8"
S49-6-4	3/8"	1/4"
S49-6-6	3/8"	3/8"
S49-8-4	1/2"	1/4"
S49-8-6	1/2"	3/8"
S49-8-8	1/2"	1/2"
S49-10-8	5/8"	1/2"

[G] FORGED FLARE X FEMALE PIPE ELBOW

P/N	TUBE	PIPE
S150-4-2	1/4"	1/8"
S150-4-4	1/4"	1/4"
S150-4-6	1/4"	3/8"
S150-5-2	5/16"	1/8"
S150-5-4	5/16"	1/4"
S150-6-4	3/8"	1/4"
S150-6-6	3/8"	3/8"
S150-6-8	3/8"	1/2"
S150-8-6	1/2"	3/8"
S150-8-8	1/2"	1/2"
S150-8-12	1/2"	3/4"
S150-10-6	5/8"	3/8"
S150-10-8	5/8"	1/2"

[H] FORGED FLARE X MALE PIPE ELBOW

P/N	TUBE	PIPE
S149-2-2	1/8"	1/8"
S149-3-2	3/16"	1/8"
S149-4-2	1/4"	1/8"
S149-4-4	1/4"	1/4"
S149-4-6	1/4"	3/8"
S149-4-8	1/4"	1/2"
S149-5-2	5/16"	1/8"
S149-5-4	5/16"	1/4"
S149-6-2	3/8"	1/8"
S149-6-4	3/8"	1/4"
S149-6-6	3/8"	3/8"
S149-6-8	3/8"	1/2"
S149-8-4	1/2"	1/4"
S149-8-6	1/2"	3/8"
S149-8-8	1/2"	1/2"
S149-8-12	1/2"	3/4"
S149-10-6	5/8"	3/8"
S149-10-8	5/8"	1/2"
S149-10-12	5/8"	3/4"
S149-12-8	3/4"	1/2"
S149-12-12	3/4"	3/4"

[I] FLARE TEE

With Male Pipe Thread on Branch

P/N	TUBE	PIPE
S45-6-2	3/8"	1/8"

[J] FORGED FLARE CROSS

Tube All 4 Ends

P/N	TUBE
S152-4	1/4"
S152-6	3/8"
S152-8	1/2"

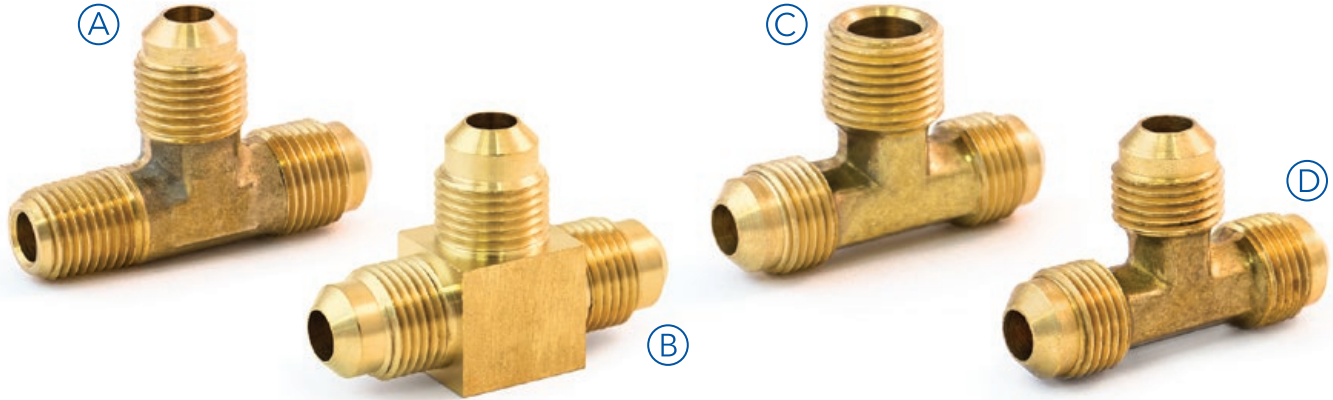

[A] FORGED FLARE TEE
With Male Pipe Thread on Run

P/N	TUBE	PIPE
S151-3-2	3/16"	1/8"
S151-4-2	1/4"	1/8"
S151-4-4	1/4"	1/4"
S151-5-2	5/16"	1/8"
S151-5-4	5/16"	1/4"
S151-6-2	3/8"	1/8"
S151-6-4	3/8"	1/4"
S151-6-6	3/8"	3/8"
S151-6-8	3/8"	1/2"
S151-8-6	1/2"	3/8"
S151-8-8	1/2"	1/2"
S151-10-8	5/8"	1/2"

[C] FORGED FLARE TEE
With Male Pipe Thread on Branch

P/N	TUBE	PIPE
S145-3-2	3/16"	1/8"
S145-4-2	1/4"	1/8"
S145-4-4	1/4"	1/4"
S145-5-2	5/16"	1/8"
S145-5-4	5/16"	1/4"
S145-6-2	3/8"	1/8"
S145-6-4	3/8"	1/4"
S145-6-6	3/8"	3/8"
S145-6-8	3/8"	1/2"
S145-8-6	1/2"	3/8"
S145-8-8	1/2"	1/2"
S145-10-8	5/8"	1/2"
S145-12-12	3/4"	3/4"

[B] FLARE TEE
Tube All 3 Ends

P/N	TUBES	BRANCH
S44-3	3/16"	3/16"
S44-4	1/4"	1/4"
S44-5	5/16"	5/16"
S44-6	3/8"	3/8"
S44-6-6-8	3/8"	1/2"
S44-8	1/2"	1/2"
S44-10	5/8"	5/8"

[D] FORGED FLARE TEE
Tube All 3 Ends

P/N	TUBES
S144-2	1/8"
S144-3	3/16"
S144-4	1/4"
S144-5	5/16"
S144-6	3/8"
S144-8	1/2"
S144-10	5/8"

45° FLARE FITTINGS

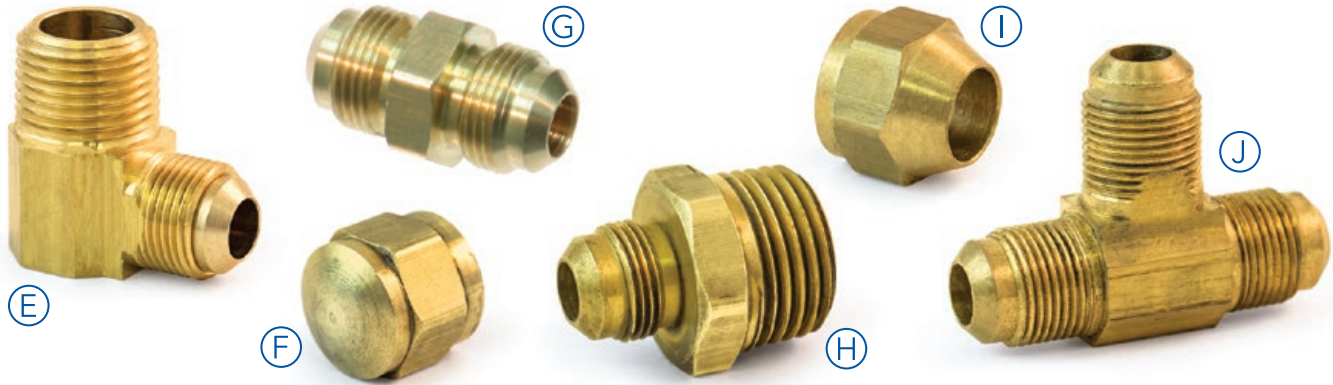

[E] FLARE X M.I.P. ELBOW
9/16"-24 Fine Thread

P/N	TUBE	PIPE
FRC16-6-6	3/8"	3/8"
FRC18-6-8	3/8"	1/2"

[H] FLARE X M.I.P. CONNECTOR
9/16"-24 Fine Thread

P/N	TUBE	PIPE
FRC11-6-6	3/8"	3/8"
FRC13-6-8	3/8"	1/2"

[F] FLARE CAP
9/16"-24 Fine Thread

P/N	TUBE
FC-6	3/8"

[I] FLARE NUT
9/16"-24 Fine Thread

P/N	TUBE
FO-6	3/8"

[G] FLARE UNION
9/16"-24 Fine Thread

P/N	TUBE
FU3-6	3/8"

[J] FLARE TEE
9/16"-24 Fine Thread, Tube All 3 Ends

P/N	TUBE
FT3-6	3/8"



INVERTED FLARE FITTINGS

FEATURES

- Inverted Flare Fittings Resist Mechanical Pull Out
- Designed to be Assembled and Disassembled Over and Over Again
- Available in a Broad Range of Sizes

APPLICATIONS

For Use with Hydraulic Brake, Transmission and Fuel Lines, Steering Lines, and LP Gas

WORKING PRESSURE

Working Pressure is Determined by Tube Thickness

TEMPERATURE RANGE

-65°F to 250°F (-54°C to 121°C)

ASSEMBLY INSTRUCTIONS

1. Cut Tubing Squarely
2. Place Nut onto Tube with the Threaded End Pointing towards the End of the Tube
3. Use a Double Flare to Prevent Pinch-Off or Cracked Flares on Thin-Wall Copper Tubing, Welded, or Brazed Tubing
4. Clamp Tube Flare Between Nut and Nose of Fitting Body by Screwing Nut on Finger Tight. Tighten with a Wrench an Additional 1/4 to 1/2 Turn Past Finger Tight for a Metal-to-Metal Seal

[A] STEEL PLUG

P/N	TUBE
S131IFS-3	3/16"
S131IFS-4	1/4"
S131IFS-5	5/16"
S131IFS-6	3/8"

[B] STEEL NUT

P/N	TUBE
S41IFS-2	1/8"
S41IFS-3	3/16"
S41IFS-4	1/4"
S41IFS-5	5/16"
S41IFS-6	3/8"
S41IFS-8	1/2"
S41IFS-10	5/8"
S41IFS-12	3/4"

[C] BRASS NUT

P/N	TUBE
S41IF-2	1/8"
S41IF-3	3/16"
S41IF-4	1/4"
S41IF-5	5/16"
S41IF-6	3/8"
S41IF-8	1/2"

[D] LONG STEEL NUT

P/N	TUBE
7896-3	3/16"
7896-4	1/4"

INVERTED FLARE FITTINGS

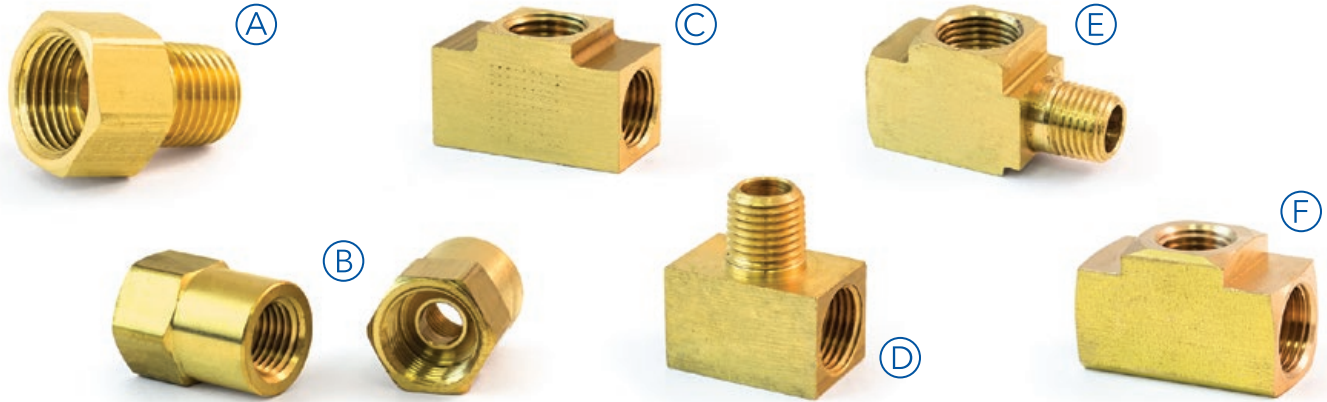

[A] MALE CONNECTOR

P/N	TUBE	PIPE
S48IF-2-2	1/8"	1/8"
S48IF-3-2	3/16"	1/8"
S48IF-4-2	1/4"	1/8"
S48IF-4-4	1/4"	1/4"
S48IF-5-2	5/16"	1/8"
S48IF-5-4	5/16"	1/4"
S48IF-6-2	3/8"	1/8"
S48IF-6-4	3/8"	1/4"
S48IF-6-6	3/8"	3/8"
S48IF-8-4	1/2"	1/4"
S48IF-8-6	1/2"	3/8"
S48IF-8-8	1/2"	1/2"
S48IF-10-8	5/8"	1/2"

[B] FEMALE CONNECTOR

P/N	TUBE	PIPE
S46IF-3-2	3/16"	1/8"
S46IF-4-2	1/4"	1/8"
S46IF-5-2	5/16"	1/8"
S46IF-6-4	3/8"	1/4"
S46IF-8-6	1/2"	3/8"

[C] UNION TEE

P/N	TUBE
S244IF-3	3/16"
S244IF-4	1/4"
S244IF-5	5/16"
S244IF-6	3/8"
S244IF-8	1/2"

[D] MALE BRANCH TEE

P/N	TUBE	PIPE
S245IF-3-2	3/16"	1/8"
S245IF-4-2	1/4"	1/8"
S245IF-5-2	5/16"	1/8"
S245IF-6-4	3/8"	1/4"

[E] MALE RUN TEE

P/N	TUBE	PIPE
S251IF-3-2	3/16"	1/8"
S251IF-4-2	1/4"	1/8"
S251IF-5-2	5/16"	1/8"
S251IF-6-4	3/8"	1/4"

[F] FEMALE BRANCH TEE

P/N	TUBE	PIPE
S252IF-3-2	3/16"	1/8"
S252IF6-4	3/8"	1/4"

INVERTED FLARE FITTINGS

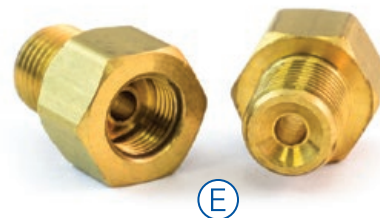
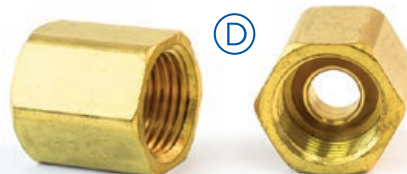
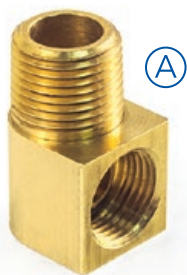

[A] MALE ELBOW

P/N	TUBE	PIPE
S249IF-2-2	1/8"	1/8"
S249IF-3-2	3/16"	1/8"
S249IF-4-2	1/4"	1/8"
S249IF-4-4	1/4"	1/4"
S249IF-5-2	5/16"	1/8"
S249IF-5-4	5/16"	1/4"
S249IF-6-2	3/8"	1/8"
S249IF-6-4	3/8"	1/4"
S249IF-6-6	3/8"	3/8"
S249IF-8-4	1/2"	1/4"
S249IF-8-6	1/2"	3/8"
S249IF-8-8	1/2"	1/2"
S249IF-10-6	5/8"	3/8"
S249IF-10-8	5/8"	1/2"

[B] FEMALE ELBOW

P/N	TUBE	PIPE
S250IF-4-2	1/4"	1/8"
S250IF-6-4	3/8"	1/4"

[C] 45° ELBOW

P/N	TUBE	PIPE
S259IF-3-2	3/16"	1/8"
S259IF-4-2	1/4"	1/8"
S259IF-5-2	5/16"	1/8"
S259IF-6-4	3/8"	1/4"
S259IF-8-6	1/2"	3/8"

[D] UNION FLARE

P/N	TUBE
S42IF-2	1/8"
S42IF-3	3/16"
S42IF-4	1/4"
S42IF-5	5/16"
S42IF-6	3/8"
S42IF-8	1/2"

[E] HYDRAULIC BRAKE ADAPTER

P/N	FLARE	TUBE
7818	1/4"	3/16"
7828	3/16"	1/4"
7829	5/16"	1/4"
7897	3/16"	5/16"



COMPRESSION FITTINGS

FEATURES

Compression Fittings Do Not Need Any Flaring, Fusing or Other Types of Tubing Preparation

APPLICATIONS

- For Use with Instrumentation and Pneumatic Systems. *Do Not Use for Gas Connections of Any Kind!*
- Designed to be Used with Aluminum, Copper, and Plastic Tubing*
- Not Recommended for Steel Tubing

WORKING PRESSURE

Working Pressure is Determined by Tube Thickness

TEMPERATURE RANGE

-65°F to 250°F (-54°C to 121°C)

ASSEMBLY INSTRUCTIONS

1. Slide Nut and Sleeve Onto Tubing
2. Insert the Tube into Fitting. The Tube Should be Bottomed on the Fitting Shoulder
3. Assemble Nut to the Body and Tighten to Finger-Tight
4. Wrench Tighten Up to 2-1/4 Turns, Depending on Size

CAUTION: Do Not Use an Adhesive or Sealing Material

* Plastic Tubing will Require an Insert and Sleeve

[A] COMPRESSION FITTING INSERT

Brass, Drop-In Style

P/N	TUBE
S63PT-4	1/4"
S63PT-5	5/16"
S63PT-6	3/8"
S63PT-8	1/2"
S63PT-10	5/8"

[B] COMPRESSION SLEEVE

P/N	TUBE
S60-2	1/8"
S60-3	3/16"
S60-4	1/4"
S60-5	5/16"
S60-6	3/8"
S60-7	7/16"
S60-8	1/2"
S60-10	5/8"
S60-12	3/4"
S60-14	7/8"

[C] ACETAL COMPRESSION SLEEVE

P/N	TUBE
S60PT-4	1/4"
S60PT-5	5/16"
S60PT-6	3/8"
S60PT-8	1/2"
S60PT-10	5/8"

[D] COMPRESSION PLUG

P/N	TUBE
CSP-4	1/4"
CSP-6	3/8"
CSP-8	1/2"
CSP-10	5/8"



[A] COMPRESSION NUT

P/N	TUBE
S61-2	1/8"
S61-3	3/16"
S61-4	1/4"
S61-5	5/16"
S61-6	3/8"
S61-7	7/16"
S61-8	1/2"
S61-10	5/8"
S61-12	3/4"
S61-14	7/8"

[B] LONG COMPRESSION NUT

P/N	TUBE
S61L-2	1/8"
S61L-3	3/16"
S61L-4	1/4"
S61L-5	5/16"
S61L-6	3/8"
S61L-8	1/2"
S61L-10	5/8"
S61L-12	3/4"

[C] COMPRESSION CAP

P/N	TUBE
S61CP-4	1/4"
S61CP-6	3/8"
S61CP-8	1/2"
S61CP-10	5/8"

[D] COMPRESSION x MPT CONNECTOR

P/N	TUBE	PIPE
S68-2-1	1/8"	1/16"
S68-2-2	1/8"	1/8"
S68-3-2	3/16"	1/8"
S68-3-4	3/16"	1/4"
S68-4-2	1/4"	1/8"
S68-4-4	1/4"	1/4"
S68-4-6	1/4"	3/8"
S68-4-8	1/4"	1/2"
S68-5-2	5/16"	1/8"
S68-5-4	5/16"	1/4"
S68-5-6	5/16"	3/8"
S68-6-2	3/8"	1/8"
S68-6-4	3/8"	1/4"
S68-6-6	3/8"	3/8"
S68-6-8	3/8"	1/2"
S68-6-12	3/8"	3/4"
S68-7-4	7/16"	1/4"
S68-8-4	1/2"	1/4"
S68-8-6	1/2"	3/8"
S68-8-8	1/2"	1/2"
S68-8-12	1/2"	3/4"
S68-10-6	5/8"	3/8"
S68-10-8	5/8"	1/2"
S68-10-12	5/8"	3/4"
S68-12-8	3/4"	1/2"
S68-12-12	3/4"	3/4"
S68-14-8	7/8"	1/2"
S68-14-12	7/8"	3/4"
S68-14-16	7/8"	1"

[E] BULKHEAD COMPRESSION UNION

P/N	TUBE
S62BH-4	1/4"
S62BH-6	3/8"

COMPRESSION FITTINGS

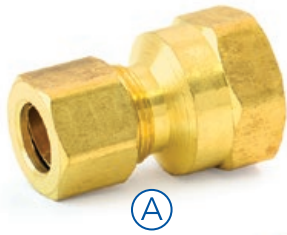

(A)



(B)



(C)



(D)

[A] COMPRESSION x FPT CONNECTOR

P/N	TUBE	PIPE
S66-2-2	1/8"	1/8"
S66-3-2	3/16"	1/8"
S66-3-4	3/16"	1/4"
S66-4-2	1/4"	1/8"
S66-4-4	1/4"	1/4"
S66-4-6	1/4"	3/8"
S66-4-8	1/4"	1/2"
S66-5-2	5/16"	1/8"
S66-5-4	5/16"	1/4"
S66-6-2	3/8"	1/8"
S66-6-4	3/8"	1/4"
S66-6-6	3/8"	3/8"
S66-6-8	3/8"	1/2"
S66-8-4	1/2"	1/4"
S66-8-6	1/2"	3/8"
S66-8-8	1/2"	1/2"
S66-10-6	5/8"	3/8"
S66-10-8	5/8"	1/2"

[B] COMPRESSION x FPT ELBOW

P/N	TUBE	PIPE
S70-3-2	3/16"	1/8"
S70-4-2	1/4"	1/8"
S70-4-4	1/4"	1/4"
S70-5-2	5/16"	1/8"
S70-5-4	5/16"	1/4"
S70-6-2	3/8"	1/8"
S70-6-4	3/8"	1/4"
S70-6-6	3/8"	3/8"
S70-6-8	3/8"	1/2"
S70-8-6	1/2"	3/8"
S70-10-8	5/8"	1/2"

[C] COMPRESSION UNION

Tube Both Ends

P/N	TUBES
S62-2	1/8"
S62-3	3/16"
S62-4-2	1/4" & 1/8"
S62-4-3	1/4" & 3/16"
S62-4	1/4"
S62-5-4	5/16" & 1/4"
S62-5	5/16"
S62-6-4	3/8" & 1/4"
S62-6-5	3/8" & 5/16"
S62-6	3/8"
S62-7	7/16"
S62-8-6	1/2" & 3/8"
S62-8	1/2"
S62-10-6	5/8" & 3/8"
S62-10-8	5/8" & 1/2"
S62-10	5/8"
S62-12	3/4"
S62-14	7/8"

[D] COMPRESSION UNION ELBOW

Tube Both Ends

P/N	TUBE
S65-2	1/8"
S65-3	3/16"
S65-4	1/4"
S65-5	5/16"
S65-6	3/8"
S65-7	7/16"
S65-8	1/2"
S65-10	5/8"
S65-12	3/4"

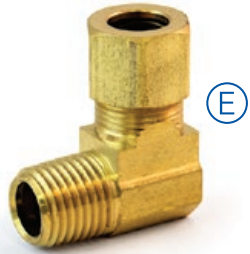

(E)

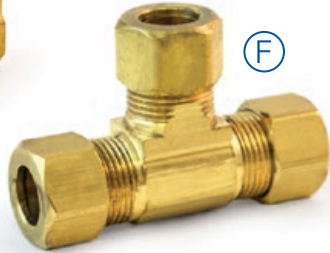

(F)



(G)

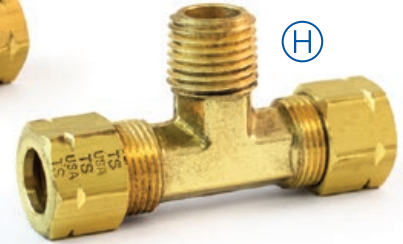

(H)

[E] COMPRESSION x MPT ELBOW

P/N	TUBE	PIPE
S69-2-2	1/8	1/8
S69-3-2	3/16	1/8
S69-3-4	3/16	1/4
S69-4-2	1/4	1/8
S69-4-4	1/4	1/4
S69-4-6	1/4	3/8
S69-5-2	5/16	1/8
S69-5-4	5/16	1/4
S69-5-6	5/16	3/8
S69-6-2	3/8	1/8
S69-6-4	3/8	1/4
S69-6-6	3/8	3/8
S69-6-8	3/8	1/2
S69-7-4	7/16	1/4
S69-7-6	7/16	3/8
S69-8-4	1/2	1/4
S69-8-6	1/2	3/8
S69-8-8	1/2	1/2
S69-10-6	5/8	3/8
S69-10-8	5/8	1/2

[F] COMPRESSION TEE

Tube All Three Ends

P/N	TUBES
S64-2	1/8"
S64-3	3/16"
S64-4	1/4"
S64-5	5/16"
S64-6-6-4	3/8" & 1/4"
S64-6	3/8"
S64-8-8-6	1/2" & 3/8"
S64-8	1/2"

[G] COMPRESSION TEE

Male Pipe Thread on Run

P/N	TUBES	PIPE
S71-2-2	1/8"	1/8"
S71-3-2	3/16"	1/8"
S71-4-2	1/4"	1/8"
S71-4-4	1/4"	1/4"
S71-5-2	5/16"	1/8"
S71-5-4	5/16"	1/4"
S71-6-2	3/8"	1/8"
S71-6-4	3/8"	1/4"
S71-6-6	3/8"	3/8"
S71-8-6	1/2"	3/8"
S71-8-8	1/2"	1/2"

[H] COMPRESSION TEE

Male Pipe Thread on Branch

P/N	TUBES	PIPE
S72-2-2	1/8"	1/8"
S72-3-2	3/16"	1/8"
S72-4-2	1/4"	1/8"
S72-4-4	1/4"	1/4"
S72-5-2	5/16"	1/8"
S72-5-4	5/16"	1/4"
S72-6-2	3/8"	1/8"
S72-6-4	3/8"	1/4"
S72-6-6	3/8"	3/8"
S72-8-6	1/2"	3/8"
S72-8-8	1/2"	1/2"
S72-10-8	5/8"	1/2"

CAPTIVE SLEEVE COMPRESSION FITTINGS

FEATURES

- Captive Sleeve Compression Fittings Do Not Need Any Flaring, Fusing or Other Types of Tubing Preparation
- Quicker to Assemble than Flare or Standard Compression Fittings
- Captive Sleeve Bodies are Interchangeable with Standard Compression Fittings

APPLICATIONS

- For Use with Instrumentation and Pneumatic Systems. **Do Not Use for Gas Connections of Any Kind!**
- Designed to be Used with Aluminum, Copper, and Plastic Tubing*
- Not Recommended for Steel Tubing

WORKING PRESSURE

Working Pressure is Determined by Tube Thickness

TEMPERATURE RANGE

-65°F to 250°F (-54°C to 121°C)

ASSEMBLY INSTRUCTIONS

1. Cut Tubing Squarely and Remove Burrs
2. Slide Nut and Sleeve Onto Tubing
3. Insert the Tube into Fitting. The Tube Should be Bottomed on the Fitting Shoulder
4. Assemble Nut to the Body and Tighten to Finger-Tight
5. Wrench Tighten Up to 2-1/4 Turns, Depending on Size

CAUTION: Do Not Use an Adhesive or Sealing Material

NOTE: As of January 1, 2014 Tramec Sloan is not Legal for Potable Water Applications, per Federal Reduction of Lead in Drinking Water Act of 2011

* Plastic Tubing will Require an Insert and Sleeve

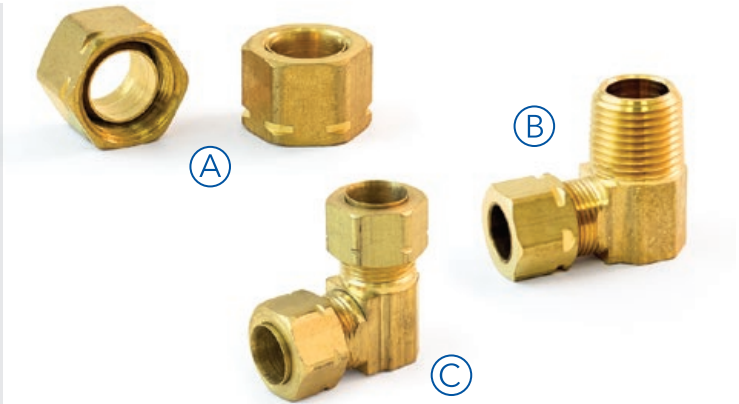

[A] COMPRESSION NUT

P/N	TUBE
61CA-2	1/8"
61CA-3	3/16"
61CA-4	1/4"
61CA-5	5/16"
61CA-6	3/8"
61CA-8	1/2"
61CA-10	5/8"
61CA-12	3/4"
61CA-14	7/8"

[B] COMPRESSION x MPT ELBOW

P/N	TUBES	PIPE
S69CA-2-2	1/8"	1/8"
S69CA-3-2	3/16"	1/8"
S69CA-4-2	1/4"	1/8"
S69CA-4-4	1/4"	1/4"
S69CA-4-6	1/4"	3/8"
S69CA-5-4	5/16"	1/4"
S69CA-5-6	5/16"	3/8"
S69CA-6-2	3/8"	1/8"
S69CA-6-4	3/8"	1/4"
S69CA-6-6	3/8"	3/8"
S69CA-8-6	1/2"	3/8"
S69CA-8-8	1/2"	1/2"

[C] COMPRESSION ELBOW

Tube Both Ends

P/N	TUBE
S65CA-4	1/4"
S65CA-5	5/16"
S65CA-6	3/8"
S65CA-8	1/2"

CAPTIVE SLEEVE COMPRESSION FITTINGS

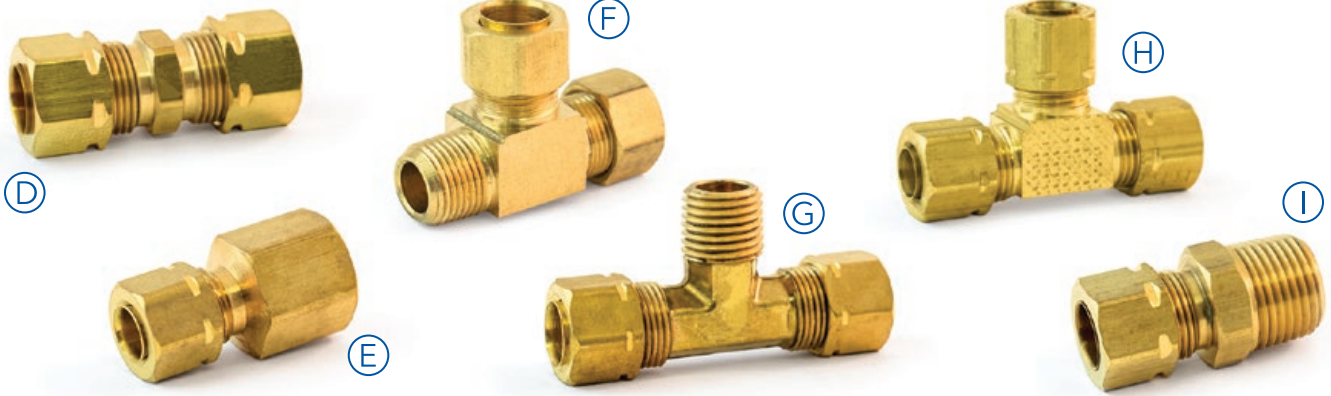

[D] COMPRESSION UNION
Tube Both Ends

P/N	TUBES
62CA-2	1/8"
62CA-3	3/16"
62CA-4	1/4"
62CA-5	5/16"
62CA-5-4	5/16" & 1/4"
62CA-6	3/8"
62CA-6-4	3/8" & 1/4"
62CA-8	1/2"
62CA-8-6	1/2" & 3/8"
62CA-10	5/8"
62CA-12	3/4"

[E] COMPRESSION x FPT UNION

P/N	TUBES	PIPE
S66CA-2-2	1/8"	1/8"
S66CA-4-2	1/4"	1/8"
S66CA-4-4	1/4"	1/4"
S66CA-6-4	3/8"	1/4"
S66CA-6-6	3/8"	3/8"
S66CA-6-8	3/8"	1/2"
S66CA-8-4	1/2"	1/4"
S66CA-8-6	1/2"	3/8"
S66CA-8-8	1/2"	1/2"

[F] COMPRESSION TEE
Male Pipe Thread on Run

P/N	TUBES	PIPE
S71CA-4-2	1/4"	1/8"
S71CA-4-4	1/4"	1/4"
S71CA-6-4	3/8"	1/4"
S71CA-6-6	3/8"	3/8"
S71CA-8-6	1/2"	3/8"
S71CA-8-8	1/2"	1/2"

[G] COMPRESSION TEE
Male Pipe Thread on Branch

P/N	TUBES	PIPE
S72CA-2-2	1/8"	1/8"
S72CA-4-2	1/4"	1/8"
S72CA-5-4	5/16"	1/4"
S72CA-6-4	3/8"	1/4"

[H] COMPRESSION TEE
Tube All Three Ends

P/N	TUBE
S64CA-2	1/8"
S64CA-3	3/16"
S64CA-4	1/4"
S64CA-6	3/8"
S64CA-8	1/2"

[I] COMPRESSION x MPT CONNECTOR

P/N	TUBES	PIPE
S68CA-2-2	1/8"	1/8"
S68CA-3-2	3/16"	1/8"
S68CA-3-4	3/16"	1/4"
S68CA-4-2	1/4"	1/8"
S68CA-4-4	1/4"	1/4"
S68CA-4-6	1/4"	3/8"
S68CA-5-2	5/16"	1/8"
S68CA-5-4	5/16"	1/4"
S68CA-6-2	3/8"	1/8"
S68CA-6-4	3/8"	1/4"
S68CA-6-6	3/8"	3/8"
S68CA-6-8	3/8"	1/2"
S68CA-8-4	1/2"	1/4"
S68CA-8-6	1/2"	3/8"
S68CA-8-8	1/2"	1/2"



HOSE BARBS

FEATURES

- Excellent Vibration Resistance

APPLICATIONS

- For Use with Rubber Hose, Rubber Tubing, and Thermoplastic Tubing
- Intended to be Used with a Clamp or Crimp System

WORKING PRESSURE

Up to 150 PSI

TEMPERATURE RANGE

-40°F to 160°F (-40°C to 71°C)

ASSEMBLY INSTRUCTIONS

1. Cut Tubing Squarely and to Length
2. Slide Hose Clamp onto Hose End
3. Lubricate Hose
4. Push Hose onto Fitting until Hose Reaches the Fitting Stop-Ring or Hex
5. Move Hose Clamp over Hose and Barb, then Tighten with Screwdriver or Wrench

[A] MALE HOSE END

P/N	HOSE I.D.	PIPE
1551A	5/16"	1/8"
1555	5/16"	1/4"
1564	3/8"	1/4"
1668-10	5/8"	1/2"
1668-10-6	5/8"	3/8"
1668-12	3/4"	1/2"

[B] HOSE BARB TO MALE PIPE THREAD

P/N	HOSE I.D.	PIPE
S125-2-2	1/8"	1/8"
S125-2-4	1/8"	1/4"
S125-3-2	3/16"	1/8"
S125-3-4	3/16"	1/4"
S125-4-2	1/4"	1/8"
S125-4-4	1/4"	1/4"
S125-4-6	1/4"	3/8"
S125-4-8	1/4"	1/2"
S125-5-2	5/16"	1/8"
S125-5-4	5/16"	1/4"
S125-5-6	5/16"	3/8"
S125-6-2	3/8"	1/8"
S125-6-4	3/8"	1/4"
S125-6-6	3/8"	3/8"
S125-6-8	3/8"	1/2"
S125-8-4	1/2"	1/4"
S125-8-6	1/2"	3/8"
S125-8-8	1/2"	1/2"
S125-8-12	1/2"	3/4"
S125-10-6	5/8"	3/8"
S125-10-8	5/8"	1/2"
S125-10-12	5/8"	3/4"
S125-12-8	3/4"	1/2"
S125-12-12	3/4"	3/4"
S125-16-12	1"	3/4"
S125-16-16	1"	1"

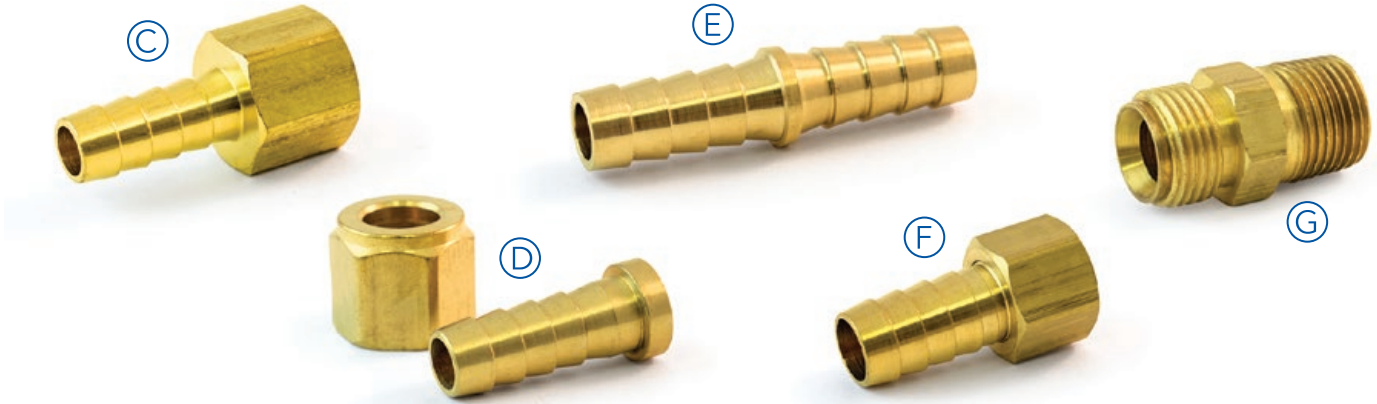

[C] HOSE BARB TO FEMALE FLARE

P/N	HOSE I.D.	PIPE
S126-2-2	1/8"	1/8"
S126-3-2	3/16"	1/8"
S126-4-2	1/4"	1/8"
S126-4-4	1/4"	1/4"
S126-4-6	1/4"	3/8"
S126-5-2	5/16"	1/8"
S126-5-4	5/16"	1/4"
S126-6-2	3/8"	1/8"
S126-6-4	3/8"	1/4"
S126-6-6	3/8"	3/8"
S126-6-8	3/8"	1/2"
S126-8-4	1/2"	1/4"
S126-8-6	1/2"	3/8"
S126-8-8	1/2"	1/2"

[D] HOSE BARB TO SWIVEL FEM. FLARE

TS P/N	HOSE I.D.	TUBE	THREAD
S146-4-4	1/4"	1/4"	7/16"-20
S146-4-6	1/4"	3/8"	5/8"-18
S146-6-6	3/8"	3/8"	5/8"-18
S146-6-8	3/8"	1/2"	3/4"-16
S146-8-8	1/2"	1/2"	3/4"-16

[E] HOSE BARB SPLICER

P/N	HOSE
S73-3	3/16"
S73-4	1/4"
S73-5	5/16"
S73-6	3/8"
S73-8	1/2"

[F] HOSE BARB TO FEMALE SWIVEL

Ball-End*

P/N	HOSE I.D.	NPSM
S128-4-4	1/4"	1/4"
S128-5-4	5/16"	1/4"
S128-6-4	3/8"	1/4"
S128-6-6	3/8"	3/8"
S128-8-6	1/2"	3/8"
S128-8-8	1/2"	1/2"
S128-12-12	3/4"	3/4"

*Use with Ball Joint Adapter P/N S127

[G] BALL JOINT ADAPTER

Adapter to Male Pipe Thread

P/N	NPSM	PIPE
S127-4-2	1/4"	1/8"
S127-4-4	1/4"	1/4"
S127-6-4	3/8"	1/4"
S127-6-6	3/8"	3/8"
S127-8-6	1/2"	3/8"
S127-8-8	1/2"	1/2"

*Use with Ball-End Hose Barb P/N S128

(A)

(C)

(E)

(B)

(D)

[A] 45° HOSE BARB TO MALE PIPE

P/N	HOSE I.D.	PIPE
S139-4-2	1/4"	1/8"
S139-5-2	5/16"	1/8"
S139-5-4	5/16"	1/4"
S139-6-2	3/8"	1/8"
S139-6-4	3/8"	1/4"
S139-6-6	3/8"	3/8"
S139-8-4	1/2"	1/4"
S139-8-6	1/2"	3/8"
S139-10-6	5/8"	3/8"

[C] SINGLE BEAD MALE HOSE BARB

P/N	HOSE I.D.	PIPE
SP34100	1"	3/4"
SP34580	5/8"	3/4"

[D] HOSE BARB TEE

P/N	HOSE
SHBT2-6	3/8"

[B] 90° HOSE BARB TO MALE PIPE

P/N	HOSE I.D.	PIPE
S129-4-2	1/4"	1/8"
S129-4-4	1/4"	1/4"
S129-5-2	5/16"	1/8"
S129-5-4	5/16"	1/4"
S129-5-6	5/16"	3/8"
S129-6-2	3/8"	1/8"
S129-6-4	3/8"	1/4"
S129-6-6	3/8"	3/8"
S129-8-4	1/2"	1/4"
S129-8-6	1/2"	3/8"
S129-10-6	5/8"	3/8"
S129-10-8	5/8"	1/2"

[E] MALE PIPE ELBOW

P/N	HOSE I.D.	PIPE
1556	5/16"	1/8"
1557	5/16"	1/4"
1571	3/8"	1/4"
1572	3/8"	1/8"
1582	1/4"	1/8"
1669-6-6	3/8"	3/8"
1669-10-6	5/8"	3/8"



LOW-PRESSURE, PUSH-ON HOSE BARBS

APPLICATIONS

- For Use with Low-Pressure Air, Oil, and Lube Lines
- NOT Recommended for Fuel or Refrigerant Applications or for Use in Air Conditioners or Heat Pumps
- NOT Appropriate for Applications Involving Extreme Pulsations

WORKING PRESSURE

Varies Based Upon Hose Used

TEMPERATURE RANGE

Varies Based Upon Hose Used

ASSEMBLY INSTRUCTIONS

1. Lubricate Insert with Soapy or Plain Water
2. Hold Hose and Push On and Up Over the First Barb
3. Continue to Push Straight On Until Hose is Seated Under Protective Plastic Cap. Keep Hands Back from Hose End Area So the Hose Can Expand

[A] MALE PIPE HOSE BARB

Push-On Rigid

P/N	HOSE	PIPE
S625-4-2	1/4"	1/8"
S625-4-4	1/4"	1/4"
S625-6-4	3/8"	1/4"
S625-6-6	3/8"	3/8"
S625-8-6	1/2"	3/8"
S625-8-8	1/2"	1/2"
S625-10-8	5/8"	1/2"
S625-12-12	3/4"	3/4"

[B] 45° MALE FLARE HOSE BARB

P/N	TUBE	THREAD
S682-4-4	1/4"	7/16"-20
S682-4-5	5/16"	1/2"-20
S682-6-6	3/8"	5/8"-18
S682-6-8	1/2"	3/4"-16
S682-8-8	1/2"	3/4"-16
S682-10-8	1/2"	3/4"-16
S682-10-10	5/8"	7/8"-14
S682-12-10	5/8"	7/8"-14

[C] HOSE BARB SPLICER

P/N	HOSE
S696-4	1/4"
S696-6	3/8"
S696-8	1/2"
S696-10	5/8"
S696-12	3/4"

PUSH-ON HOSE BARBS

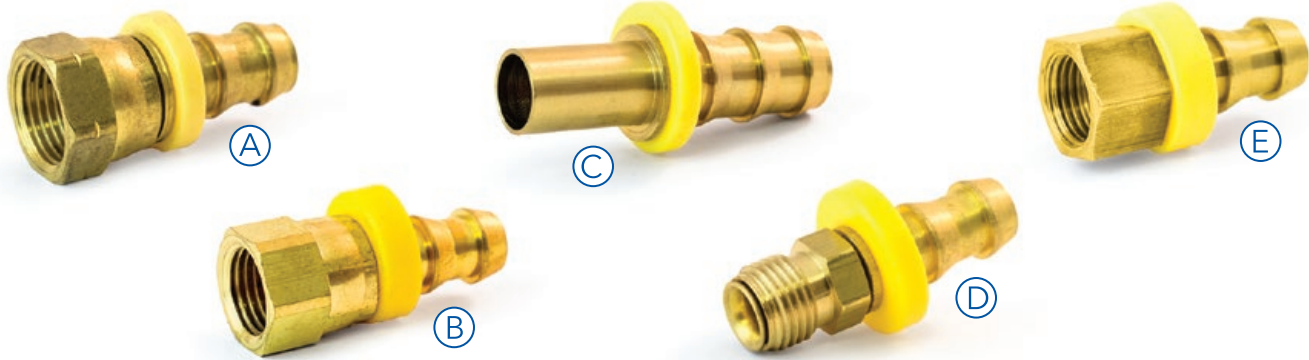

[A] 45° FEMALE FLARE HOSE BARB
Push-On Swivel

P/N	HOSE	FLARE
S684-4-4	1/4"	1/4"
S684-4-5	1/4"	5/16"
S684-6-6	3/8"	3/8"
S684-8-8	1/2"	1/2"
S684-10-10	5/8"	5/8"

[B] 37° FEMALE JIC FLARE HOSE BARB
Push-On Swivel

P/N	HOSE	TUBE	THREAD
S688-6-6	3/8"	3/8"	9/16"-18
S688-12-12	3/4"	3/4"	1-1/16"-12

[C] RIGID TUBE SHANK HOSE BARB

P/N	HOSE	TUBE
S694-4-3	1/4"	3/16"
S694-4-4	1/4"	1/4"
S694-4-5	1/4"	5/16"
S694-6-6	3/8"	3/8"
S694-8-8	1/2"	1/2"
S694-10-10	5/8"	5/8"

[D] MALE SWIVEL HOSE BARB
SAE Inverted Flare

P/N	HOSE	TUBE	THREAD
S690-4-3	1/4"	3/16"	3/8"-24
S690-4-4	1/4"	1/4"	7/16"-20
S690-5-4	5/16"	1/4"	7/16"-20
S690-5-5	5/16"	5/16"	1/2"-20
S690-5-6	5/16"	3/8"	5/8"-18
S690-6-5	3/8"	5/16"	1/2"-20
S690-6-6	3/8"	3/8"	5/8"-18
S690-8-8	1/2"	1/2"	3/4"-18
S690-10-10	5/8"	5/8"	7/8"-18

[E] RIGID FEMALE HOSE BARB
SAE Inverted Flare

P/N	HOSE	TUBE	THREAD
S692-4-3	1/4"	3/16"	3/8"-24
S692-4-4	1/4"	1/4"	7/16"-24
S692-4-5	5/16"	1/4"	1/2"-20
S692-6-5	3/8"	5/16"	1/2"-20
S692-6-6	3/8"	3/8"	5/8"-18
S692-8-8	1/2"	1/2"	3/4"-18



GARDEN HOSE FITTINGS

APPLICATIONS

For Use in Garden Hose Applications with Low Pressure

WORKING PRESSURE

Varies Based Upon the Hose Being Used

TEMPERATURE RANGE

Varies Based Upon the Hose Being Used

INDUSTRY STANDARDS

We Recommend a Sample to Verify Compliance to Desired Specifications and Suitability for Your Particular Application

NOTE: As of January 1, 2014 Tramec Sloan is not Legal for Potable Water Applications, per Federal Reduction of Lead in Drinking Water Act of 2011

[A] GARDEN HOSE NUT

P/N	FHT
HNH-1	3/4"

[B] GARDEN HOSE CAP

P/N	FHT
HC-1	3/4"

[C] GARDEN HOSE CAP

With 8" Chain

P/N	FHT
HC-8	3/4"

[D] FEMALE PIPE x FEMALE HOSE

P/N	PIPE	FHT
HU11-8-12	1/2"	3/4"
HU11-12-12	3/4"	3/4"

[E] FLARE x MALE HOSE

P/N	TUBE O.D.	MHT
HFU22-6-12	3/8"	3/4"
HFU22-8-12	1/2"	3/4"

GARDEN HOSE FITTINGS



[A] FEMALE PIPE x FEMALE HOSE SWIVEL

P/N	PIPE	FHT
HUS11-8-12	1/2"	3/4"
HUS11-12-12	3/4"	3/4"

[D] MALE PIPE x FEMALE HOSE

P/N	PIPE	FHT
HU21-8-12	1/2"	3/4"
HU21-12-12	3/4"	3/4"

[B] FEMALE HOSE x FEMALE HOSE SWIVEL

P/N	FHT
HUS-12	3/4"

[E] FEMALE PIPE x MALE HOSE

P/N	PIPE	MHT
HU12-8-12	1/2"	3/4"
HU12-12-12	3/4"	3/4"

[C] FLARE TO FEMALE HOSE SWIVEL

P/N	TUBE O.D.	FHT
S66H-6-12	3/8"	3/4"
S66H-8-12	1/2"	3/4"

[F] MALE PIPE X MALE HOSE THREAD

With 1/2" Female Pipe Thread on Male End

P/N	FPT	MPT	MHT
HUF22-12-12	1/2"	3/4"	3/4"



(A)



(C)



(B)



(D)



(E)



(F)

[A] MALE PIPE X MALE HOSE THREAD

P/N	PIPE	MHT
HU22-12MH	3/4"	3/4"
HU22-8-12	1/2"	3/4"
HU22-12-12	3/4"	3/4"

[D] HOSE Y FITTING

P/N	MHT	FHT
Y-9	3/4"	3/4"

[B] MALE PIPE TO FEMALE HOSE SWIVEL

TS P/N	PIPE	FHT
62H-4-12	3/4"	1/4"

[E] BARB TO FEMALE GARDEN HOSE

Swivel, Round Nut

P/N	HOSE O.D.	FHT
HU126-8-12	1/2"	3/4"
HU126-10-12	5/8"	3/4"

[C] BARB TO MALE GARDEN HOSE

P/N	BARB O.D.	MHT
HU125-8-12	1/2"	3/4"
HU125-10-12	5/8"	3/4"
HU125-12-12	3/4"	3/4"

[F] BARB TO FEMALE GARDEN HOSE

Swivel, Hex Nut

P/N	BARB O.D.	FHT
HU126-8-12H	1/2"	3/4"
HU126-10-12H	5/8"	3/4"
HU126-12-12H	3/4"	3/4"

GREASE FITTINGS



SAE - STRAIGHT

P/N	IMAGE	OVERALL LENGTH	PIPE THREAD	HEX SIZE
491807	A	35/64"	1/4"-28	5/16"
491808	B	15/16"	1/4"-28	5/16"

SAE - ANGLED

P/N	IMAGE	OVERALL LENGTH	PIPE THREAD	HEX SIZE	ANGLE
491809	C	13/16"	1/4"-28	3/8"	45°
491810	D	3/4"	1/4"-28	3/8"	90°

DRIVE

P/N	IMAGE	OVERALL LENGTH	PIPE THREAD	HEX SIZE
491813	E	17/32"	3/16"	5/16"
491814	F	35/64"	1/4"	5/16"
491815*	G	35/64"	5/16"	3/8"

* No ball check in fitting

UNF

P/N	IMAGE	OVERALL LENGTH	PIPE THREAD	HEX SIZE
491816	H	9/16"	5/16"-24	3/8"
491817	I	81/128"	3/8"-24	7/16"

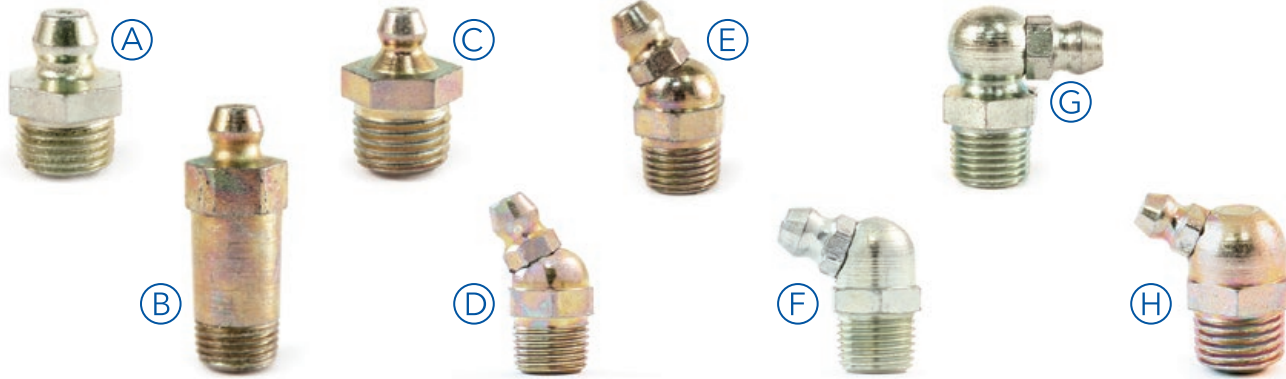

PIPE THREAD - STRAIGHT

P/N	IMAGE	OVERALL LENGTH	PIPE THREAD	HEX SIZE
491801	A	21/32"	1/8"-27	7/16"
491802	B	1-1/4"	1/8"-27	7/16"
491811	C	7/8"	1/4"-28	9/16"

PIPE THREAD - ANGLED

P/N	IMAGE	OVERALL LENGTH	PIPE THREAD	HEX SIZE	ANGLE
491803	D	29/32"	1/8"-27	7/16"	30°
491804	E	55/64"	1/8"-27	7/16"	45°
491805	F	55/64"	1/8"-27	7/16"	65°
491806	G	27/32"	1/8"-27	7/16"	90°
491812	H	31/32"	1/4"-28	9/16"	45°

GREASE FITTING ASSORTMENT

- Sturdy, Compact Case
- Visual Key Inside the Lid Makes it Simple to Quickly Find the Part You Need!
- Packaged Kit Includes 100 Standard Thread Grease Fittings:

491807 (x60)	491810 (x6)
491801 (x20)	491804 (x4)
491809 (x6)	491806 (x4)

P/N	DESCRIPTION
491800	Grease Fitting Assortment



TRUCK & BALL VALVES

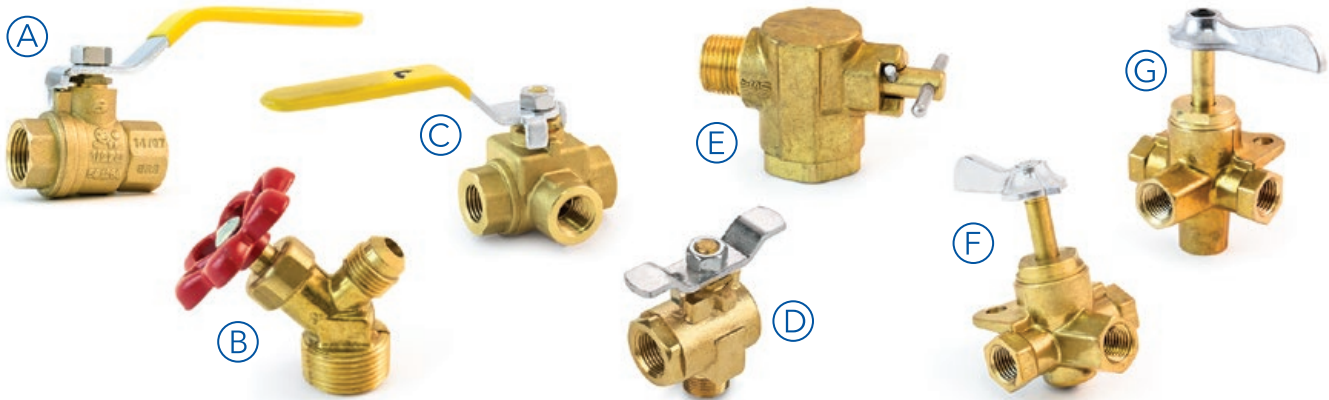

[A] FEMALE X FEMALE BALL VALVE
600 PSI Water/Oil/Gas

P/N	PIPE
SV500P-4	1/4"
SV500P-6	3/8"
SV500P-8	1/2"
SV500P-12	3/4"
SV500P-16	1"

[B] 45° OIL TANK VALVE

P/N	TUBE	PIPE	STRAIGHT
SOVF45-6-12	3/8"	3/4"	1/2"-20

[C] 3-WAY, 3-PORT BALL VALVE

- Side Outlet
- 600 PSI Water/Oil/Gas
- Blow-Out Proof Stem

P/N	PIPE
401812	1/4"

[D] 90° BALL VALVE

Female Pipe to Male Pipe

P/N	FEMALE	MALE	HANDLE
401814	1/2"	1/2"	Needle
401815	1/2"	1/2"	T-Handle

[E] FEMALE PIPE TO MALE PIPE
Pin Handle

P/N	HOSE	PIPE THREAD
SV590PH-6	3/8"	3/8"
SV590PH-8	1/2"	1/2"

[F] 3-WAY SELECTOR VALVE

P/N	STYLE	PIPE	STEM*
SV406P-4	No Click	1/4"	1-3/8"
SVC406P-4	Click	1/4"	1-3/8"
SV406P-6	No Click	3/8"	1-3/8"
SVC406P-6	Click	3/8"	1-3/8"

* Measured from top of bracket to underside of handle

[G] 4-WAY SELECTOR VALVE

P/N	STYLE	PIPE	STEM*
SV407P-4	No Click	1/4"	1-3/8"
SVC407P-4	Click	1/4"	1-3/8"
SV407P-6	No Click	3/8"	1-3/8"
SVC407P-6	Click	3/8"	1-3/8"

* Measured from top of bracket to underside of handle



[A] TRUCK VALVE
Hose to Male Pipe

P/N	HOSE	PIPE
SV404P-6-6	3/8"	3/8"
SV404P-10-6	5/8"	3/8"
SV404P-10-8	5/8"	1/2"
SV404P-12-6	3/4"	3/8"
SV404P-12-8	3/4"	1/2"

[D] TRUCK VALVE
Flare to Male Pipe

P/N	FLARE	PIPE
883-66	3/8"	3/8"
883-86	1/2"	3/8"
883-88	1/2"	1/2"
883-108	5/8"	1/2"

[B] TRUCK VALVE
Hose to Male Pipe, Pin Handle

P/N	HOSE	PIPE THREAD
SV404PH-6-6*	3/8"	3/8"
SV404PH-10-6	5/8"	3/8"

* Barbed hose end

[E] TRUCK VALVE
Male Pipe to Flare

P/N	PIPE	FLARE
887-88	1/2"	1/2"
887-810	1/2"	5/8"

[C] TRUCK VALVE
Female Pipe to Male Pipe

P/N	FEMALE	MALE
SV405P-6-6	3/8"	3/8"
SV405P-6-8	3/8"	1/2"
SV405P-8-8	1/2"	1/2"

[F] TRUCK VALVE
Nylon Air Brake to Male Pipe

P/N	AIR BRAKE	PIPE
886-88	1/2"	1/2"

[G] TRUCK VALVE
Male Pipe to Nylon Air Brake

P/N	PIPE	AIR BRAKE
889-88	1/2"	1/2"



DRAIN COCKS & SHUT-OFF VALVES

APPLICATIONS

- For Use with Low-Pressure Air, Water, Gas, and Fluids
- Some Lubricant Fluids May Not Be Compatible with Needle Valves

WORKING PRESSURE

Ground Plug Shut-Offs: Up to 30 PSI
Industrial Drain Cocks: Up to 150 PSI

TEMPERATURE RANGE

Varies. System Temperature and Tubing Type Must be Considered

INDUSTRY STANDARDS

We Recommend a Sample to Verify Compliance to Desired Specifications and Suitability for Your Particular Application

[A] DRAIN COCKS & DRAIN VALVES

For Air Tanks

P/N	PIPE
35HD	1/4"

[B] DOUBLE FEMALE DRAIN PIPE

With Shut-Off Valve

P/N	PIPE
6800	1/8"
6805	1/4"

[C] COOLER DRAIN

P/N	PIPE
CD-1	1/4"

[D] DRAIN VALVE FOR AIR TANKS

P/N	PIPE
DCR601-4	1/4"

[E] FLARE TO MALE PIPE - ANGLE

P/N	TUBE	PIPE
NV101-4-2	1/4"	1/8"
NV101-5-2	5/16"	1/8"
NV101-6-4	3/8"	1/4"

[F] FLARE TO FLARE

P/N	PIPE
NV102-4	1/4"
NV102-6	3/8"

DRAIN COCKS & SHUT-OFF VALVES

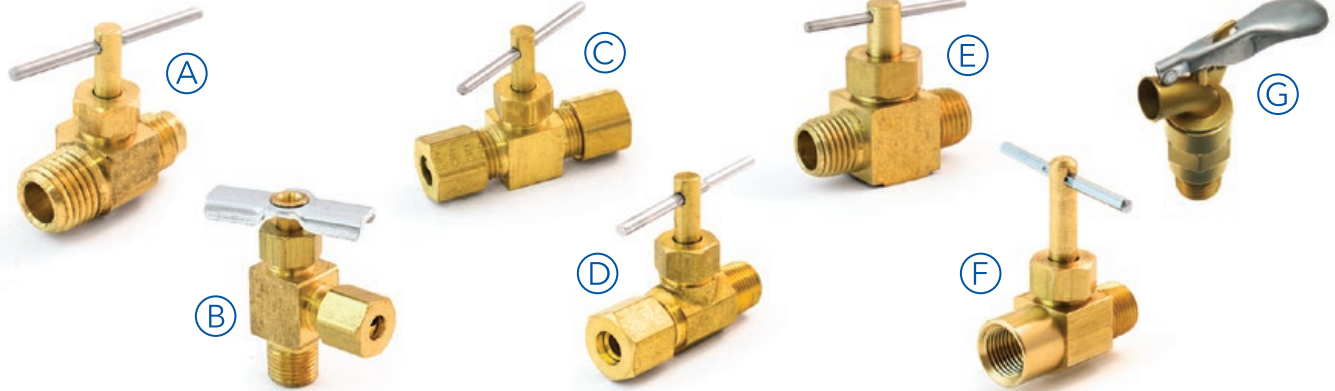

[A] FLARE TO MALE PIPE
Straight

P/N	TUBE	PIPE
NV103-4-2	1/4"	1/8"
NV103-4-4	1/4"	1/4"
NV103-6-4	3/8"	1/4"

[B] COMPRESSION TO MALE PIPE
Angled

P/N	TUBE	PIPE
NV104-3-2	3/16"	1/8"
NV104-4-2	1/4"	1/8"
NV104-4-4	1/4"	1/4"
NV104-5-2	5/16"	1/8"
NV104-6-4	3/8"	1/4"

[C] COMPRESSION TO COMPRESSION

P/N	PIPE
NV105-3	3/16"
NV105-4	1/4"
NV105-5	5/16"
NV105-6	3/8"

[D] COMPRESSION TO MALE PIPE
Straight

P/N	TUBE	PIPE
NV106-3-2	3/16"	1/8"
NV106-4-2	1/4"	1/8"
NV106-4-4	1/4"	1/4"
NV106-5-2	5/16"	1/8"
NV106-6-4	3/8"	1/4"

[E] MALE PIPE TO MALE PIPE

P/N	PIPE
NV107-2	1/8"
NV107-4	1/4"

[F] FEMALE PIPE TO MALE PIPE

P/N	PIPE
NV108-2	1/8"
NV108-4	1/4"

[G] SELF-CLOSING BARREL FAUCET

P/N	PIPE
PSB640	1/4"

DRAIN COCKS & SHUT-OFF VALVES

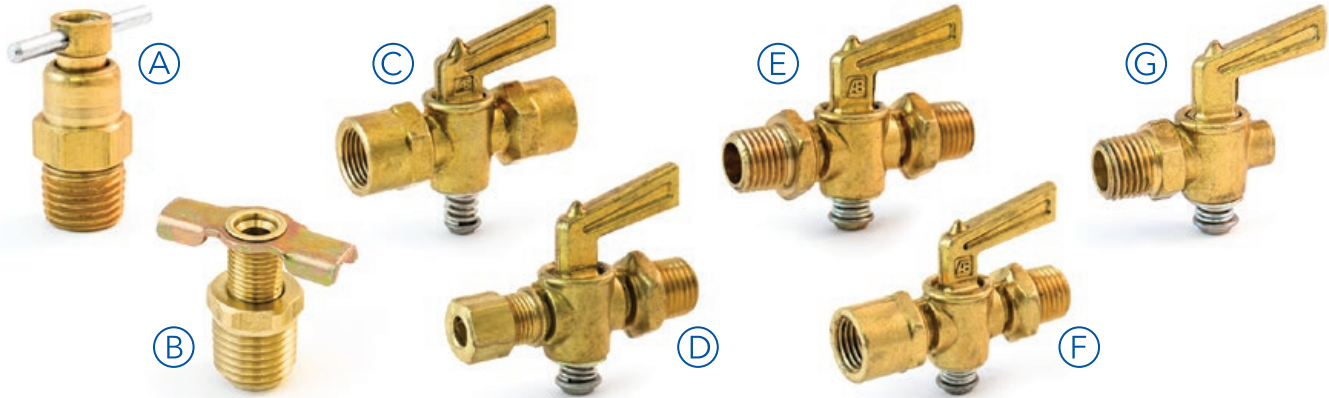

[A] MALE PIPE DRAIN COCK
Internal Seat, 150 PSI Max

P/N	THREAD	LENGTH	C-HEX
SDC603-4	1/4"	1.30"	9/16"

[B] MALE PIPE DRAIN COCK
External Seat, 150 PSI Max

P/N	THREAD	LENGTH	C-HEX
SDC604-2	1/8"	.90"	7/16"
SDC604-4	1/4"	1.00"	9/16"
SDC604-6	3/8"	1.25"	11/16"
SDC604-8	1/2"	1.50"	7/8"

[C] FEMALE PIPE TO FEMALE PIPE
30 PSI Max

P/N	THREAD	HEIGHT	WIDTH
SFF209-2	1/8"	1.90"	1.50"
SFF209-4	1/4"	1.90"	1.65"
SFF209-6	3/8"	2.30"	2.00"
SFF209-8	1/2"	2.30"	2.40"

[D] COMPRESSION TO MALE PIPE
30 PSI Max

P/N	TUBE	PIPE THREAD	STRAIGHT THREAD	HEIGHT	WIDTH
SVC206-4-2	1/4"	1/8"	7/16"-24	1.90"	2.00"
SVC206-4-4	1/4"	1/4"	7/16"-24	1.90"	1.90"
SVC206-6-4	3/8"	1/4"	9/16"-24	2.30"	2.00"

[E] MALE PIPE TO MALE PIPE
30 PSI Max

P/N	THREAD	HEIGHT	WIDTH
SV401-2	1/8"	1.90"	1.85"
SV401-4	1/4"	1.90"	1.85"
SV401-6	3/8"	2.38"	2.25"

[F] FEMALE PIPE TO MALE PIPE
30 PSI Max

P/N	THREAD	HEIGHT	WIDTH
SV402-2	1/8"	1.90"	1.85"
SV402-4	1/4"	1.90"	1.85"
SV402-6	3/8"	2.38"	2.25"

[G] MALE PIPE GROUND PLUG VALVE

P/N	THREAD	HEIGHT	WIDTH
SV601-2	1/8"	1.90"	1.40"
SV601-4	1/4"	1.90"	1.50"
SV601-6	3/8"	2.30"	1.75"
SV601-8	1/2"	2.30"	1.90"



LEAD-FREE BRASS FITTINGS

APPLICATIONS

- For Use with Brass, Copper, or Iron Pipes
- For Use in Water, Grease, Fuels, LP and Natural Gases, Refrigeration, Instrumentation, and Hydraulic Systems
- Designed for Low and Medium Pressure Pipe Line Connections

TEMPERATURE RANGE

-65°F to 250°F (-54°C to 121°C)

INDUSTRY STANDARDS

We Recommend a Sample to Verify Compliance to Desired Specifications and Suitability for Your Particular Application

ASSEMBLY INSTRUCTIONS

1. Tighten Approximately 1-1/2 Turns Past Hand Tight
2. Always Orient Shapes by Turning Clockwise, Never by Backing the Fittings Out

[A] FLARE CAP

P/N	TUBE
LF40-4	1/4"
LF40-6	3/8"
LF40-8	1/2"
LF40-10	5/8"

[B] FLARE NUT - SHORT

P/N	TUBE
LF41S-4	1/4"
LF41S-6	3/8"
LF41S-8	1/2"

[C] FLARE UNION - TUBE BOTH ENDS

P/N	TUBES
LF42-6	3/8"
LF42-10	5/8"

[D] FLARE X FEMALE PIPE CONNECTOR

P/N	TUBE	PIPE
LF46-6-6	3/8"	3/8"
LF46-6-8	3/8"	1/2"
LF46-8-6	1/2"	3/8"
LF46-8-8	1/2"	1/2"
LF46-8-12	1/2"	3/4"

[E] FLARE X MALE PIPE CONNECTOR

P/N	TUBE	PIPE
LF48-4-4	1/4"	1/4"
LF48-4-8	1/4"	1/2"
LF48-6-2	3/8"	1/8"

LEAD-FREE BRASS FITTINGS

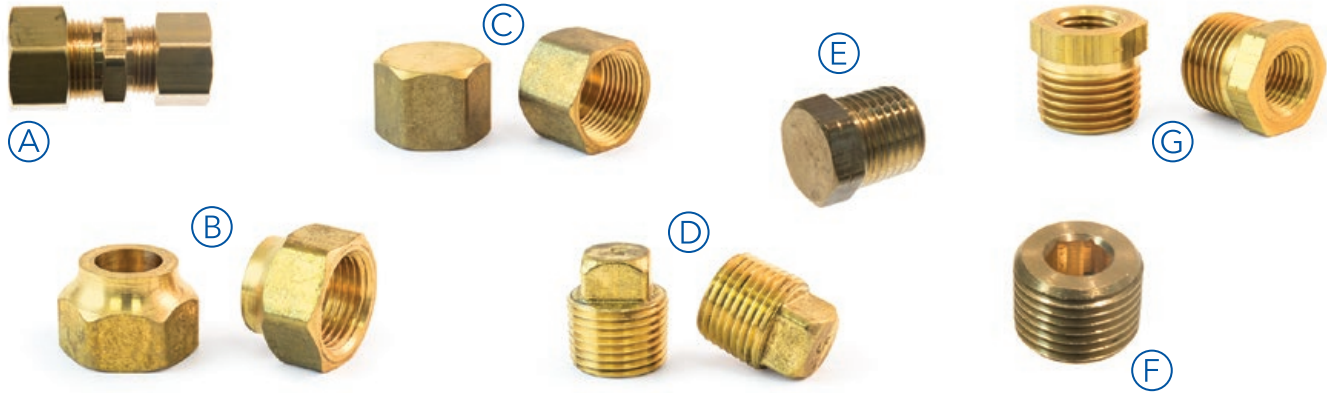

[A] COMPRESSION UNION
Tube Both Ends

P/N	TUBES
LF62-6-4	3/8" & 1/4"
LF62-8-6	1/2" & 3/8"
LF62-10-8	5/8" & 1/2"

[E] HEX HEAD PIPE PLUG
Hollow Cored

P/N	PIPE
LF73152-2	1/8"
LF73152-4	1/4"

[B] SHORT REFRIGERATION NUT

P/N	FLARE	TUBE
LF141S-6	3/8"	3/8"
LF141S-8	1/2"	1/2"
LF141S-10	5/8"	5/8"

[F] HEX COUNTERSINK PIPE PLUG

P/N	PIPE
LF73155-6	3/8"
LF73155-8	1/2"

[C] PIPE CAP

P/N	PIPE
LF73129-6	3/8"
LF73129-8	1/2"
LF73129-12	3/4"

[G] PIPE - REDUCER BUSHING

P/N	TUBE	PIPE
LF73220-4-2	1/4"	1/8"
LF73220-6-4	3/8"	1/4"
LF73220-8-4	1/2"	1/4"
LF73220-8-6	1/2"	3/8"
LF73220-12-8	3/4"	1/2"

[D] SQUARE HEAD PIPE PLUG

P/N	PIPE
LF73151-2	1/8"
LF73151-4	1/4"
LF73151-8*	1/2"
LF73151-12*	3/4"

* Cored

LEAD-FREE BRASS FITTINGS

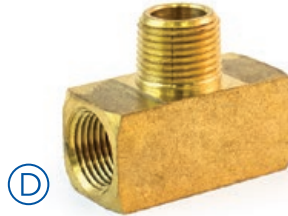
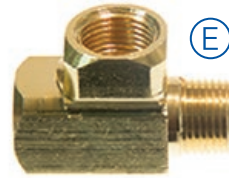
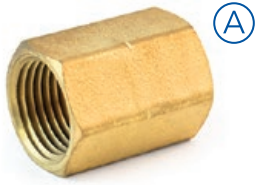

[A] FEMALE PIPE COUPLING

P/N	PIPE
LF73300-4	1/4"
LF73300-6	3/8"
LF73300-8	1/2"

[D] MALE BRANCH TEE

P/N	TUBES	PIPE
LF73600-6	3/8"	3/8"

[B] CLOSE NIPPLE

P/N	PIPE
LF73326-2	1/8"
LF73326-4	1/4"
LF73326-6	3/8"
LF73326-8	1/2"
LF73326-12	3/4"

[E] PIPE STREET TEE

P/N	PIPE
LF73750-4	1/4"
LF73750-6	3/8"

[C] LONG BRASS NIPPLE

P/N	PIPE
LF73327-4	1/4"
LF73327-6	3/8"
LF73327-8	1/2"

[F] BARB TO MALE GARDEN HOSE

P/N	BARB O.D.	MALE HOSE
LFHU125-8-12	1/2"	3/4"
LFHU125-10-12	5/8"	3/4"
LFHU125-12-12	3/4"	3/4"

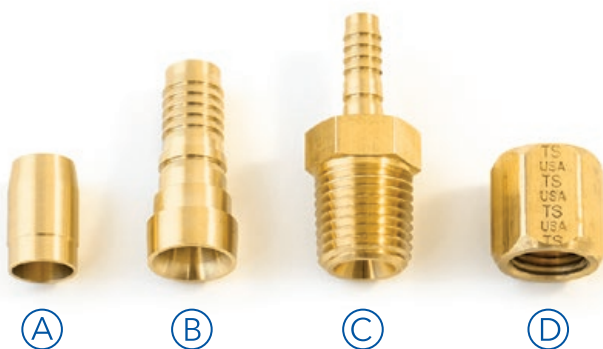

PTFE FITTINGS

APPLICATIONS

For Use with PTFE Hose in a Wide Variety of Applications Such As: Food Production, Medical, Automotive Shock Tubes, Fuel Lines, and More.

INDUSTRY STANDARDS

We Recommend a Sample to Verify Compliance to Desired Specifications and Suitability for Your Particular Application

NOTE: As of January 1, 2014 Tramec Sloan is not Legal for Potable Water Applications, per Federal Reduction of Lead in Drinking Water Act of 2011

[A] COLLAR

P/N	TUBE
TS-COL-BR-03	3/16"
TS-COL-BR-04	1/4"
TS-COL-BR-05	5/16"
TS-COL-BR-06	3/8"
TS-COL-BR-08	1/2"
TS-COL-BR-10	5/8"
TS-COL-BR-12	3/4"
TS-COL-BR-16	1"

[B] FEMALE JIC INSERT

P/N	BARB
TS-INS-BR-03JIC	3/16"
TS-INS-BR-04JIC	1/4"
TS-INS-BR-05JIC	5/16"
TS-INS-BR-06JIC	3/8"
TS-INS-BR-08JIC	1/2"
TS-INS-BR-10JIC	5/8"
TS-INS-BR-12JIC	3/4"
TS-INS-BR-16JIC	1"

[C] MALE PIPE INSERT

P/N	PIPE	BARB
TS-INS-BR-04X03MP	1/4"	3/16"
TS-INS-BR-04MP	1/4"	1/4"
TS-INS-BR-05MP	5/16"	5/16"
TS-INS-BR-06X04MP	3/8"	1/4"
TS-INS-BR-06MP	3/8"	3/8"
TS-INS-BR-08X06MP	1/2"	3/8"
TS-INS-BR-08MP	1/2"	1/2"
TS-INS-BR-10MP	5/8"	5/8"
TS-INS-BR-12MP	3/4"	3/4"
TS-INS-BR-16MP	1"	1"

[D] JIC NUT

P/N	PIPE
TS-NUT-BR-03	3/16"
TS-NUT-BR-04	1/4"
TS-NUT-BR-05	5/16"
TS-NUT-BR-06	3/8"
TS-NUT-BR-08	1/2"
TS-NUT-BR-10	5/8"
TS-NUT-BR-12	3/4"
TS-NUT-BR-16	1"

TUBE OUTER DIAMETERS

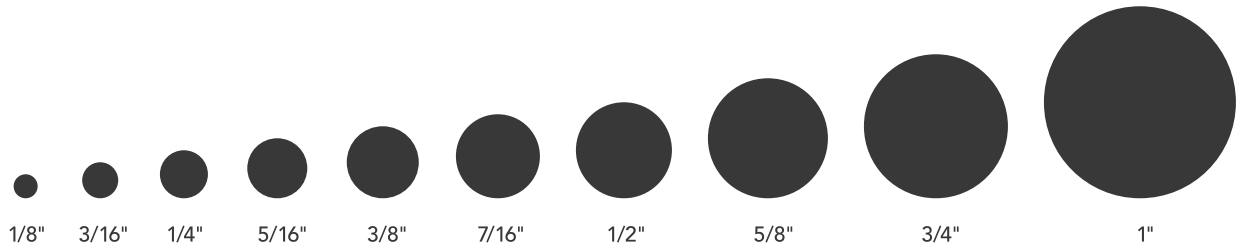

P/N CODE	TUBE
-1	1/16"
-5/32	5/32"
-2	1/8"
-3	3/16"
-4	1/4"

P/N CODE	TUBE
-5	5/16"
-6	3/8"
-7	7/16"
-8	1/2"
-10	5/8"

P/N CODE	TUBE
-12	3/4"
-16	1"
-20	1-1/4"
-24	1-1/2"
-32	2"

PIPE THREAD SIZES

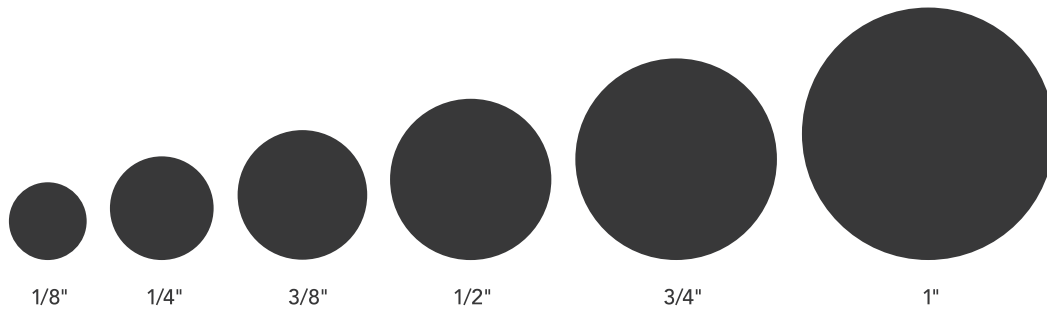

P/N CODE	NPT	TPI
-1	1/16"	27
-2	1/8"	27
-4	1/4"	18
-5	5/16"	18
-6	3/8"	18
-8	1/2"	14

P/N CODE	NPT	TPI
-10	5/8"	14
-12	3/4"	14
-16	1"	11-1/2
-20	1-1/4"	11-1/2
-24	1-1/2"	11-1/2
-32	2"	11-1/2

BIN ASSORTMENTS

- Assortments Feature a Broad Selection of the Most Popular Fittings
- Each Assortment is Supplied with its Own Set of Labels which Include Image, Size & Part Number
- Receive a **Free Storage Bin** (424305) with Each Assortment Order!
- Assortments Also Include a Fitting Reorder Form and Bin Layout Diagram

BIN ASSORTMENT 424302

Pipe Fittings

P/N	DESCRIPTION	QTY
S120-4-2	Pipe Adapter	10
S120-6-4	Pipe Adapter	5
S120-8-6	Pipe Adapter	5
S202-2	Street Elbow	5
S202-4	Street Elbow	5
S202-6	Street Elbow	5
S202-8	Street Elbow	5
S203-4	Pipe Tee	5
S203-6	Pipe Tee	5
S207-2	Female Pipe Coupling	10
S207-4	Female Pipe Coupling	5
S207-6	Female Pipe Coupling	5
S207-8	Female Pipe Coupling	5
S211-4	Square Head Pipe Plug	10
S211-6	Square Head Pipe Plug	10
S211-8	Square Head Pipe Plug	5
S215-4	Close Pipe Nipple	10
S215-6	Close Pipe Nipple	10
S215-8	Close Pipe Nipple	10
SPHN-4	Hex Nipple	10
SPHN-6	Hex Nipple	10
SPHN-8	Hex Nipple	5
SPPH-12	Hex Head Pipe Plug	5
SPPH-4	Hex Head Pipe Plug	10
SPPH-6	Hex Head Pipe Plug	10
SPPH-8	Hex Head Pipe Plug	10
SPRB-4-2	Pipe Reducer	10
SPRB-6-4	Pipe Reducer	10
SPRB-8-4	Pipe Reducer	10
SPRB-8-6	Pipe Reducer	10

BIN ASSORTMENT 424303

Nylon Tube Fittings

P/N	DESCRIPTION	QTY
S760AB-4	Nylon Tube Sleeve	20
S760AB-6	Nylon Tube Sleeve	20
S760AB-8	Nylon Tube Sleeve	20
S761AB-4	Nylon Tube Nut	10
S761AB-6	Nylon Tube Nut	10
S761AB-8	Nylon Tube Nut	8
S762AB-10	Union	4
S762AB-4	Union	10
S762AB-6	Union	8
S762AB-8	Union	6
S763AB-10	Insert	10
S763AB-4	Insert	10
S763AB-6	Insert	10
S763AB-8	Insert	10
S764AB-4	Union Tee	6
S764AB-6	Union Tee	6
S768AB-10-8	Male Connector	6
S768AB-4-2	Male Connector	6
S768AB-4-4	Male Connector	6
S768AB-6-2	Male Connector	6
S768AB-6-4	Male Connector	6
S768AB-6-6	Male Connector	6
S768AB-8-4	Male Connector	4
S768AB-8-6	Male Connector	6
S768AB-8-8	Male Connector	6
S769AB-4-2	Male Elbow	6
S769AB-4-4	Male Elbow	4
S769AB-4-6	Male Elbow	6
S769AB-6-4	Male Elbow	6
S769AB-6-6	Male Elbow	6
S769AB-8-4	Male Elbow	4
S769AB-8-6	Male Elbow	6

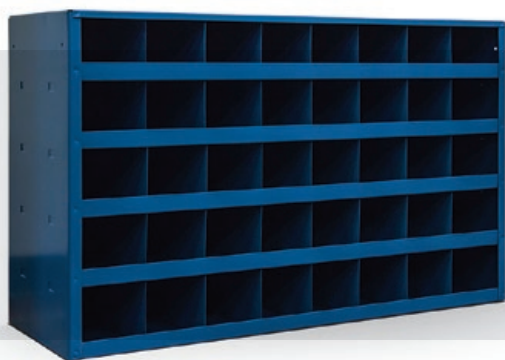

(Not Actual Size)

BIN ASSORTMENT 424304

Rubber Air Brake Hose Fittings

P/N	DESCRIPTION	QTY
S360AB-6	Hose Sleeve	10
S360AB-8	Hose Sleeve	5
S361AB-6	Reusable Nut	10
S361AB-8	Reusable Nut	10
S362RB-6	Union	5
S362RB-8	Union	2
S363RB-6	Fem. Swivel Conn. w/ Adapter	2
S368AB-6-4	Fem. Swivel Conn. w/ Adapter	5
S368AB-6-4-1	Male Connector Body	10
S368AB-6-6	Male Connector Body	5
S368AB-6-6-1	Male Connector Body	10
S368AB-6-8	Male Connector Body	5
S368AB-6-8-1	Male Connector Body	10
S368AB-8-6	Male Connector Body	2
S368AB-8-8	Male Connector Body	2
S371ABS-6	Spring Guard w/ Nut	5
S371ABS-8	Spring Guard w/ Nut	5
S376AB-3/4-6	Adapter	10
S376AB-7/8-6	Adapter	10
S378AB-6-4	Male Connector w/ Spring	2
S378AB-6-6	Male Connector w/ Spring	2
S378AB-6-8	Male Connector w/ Spring	2
S378AB-8-6	Male Connector w/ Spring	2
S378AB-8-8	Male Connector w/ Spring	2

BIN ASSORTMENT 424307

Composite Push-to-Connect Fittings

P/N	DESCRIPTION	QTY
S754PMT-4-2	45° Male Swivel Elbow	5
S754PMT-6-4	45° Male Swivel Elbow	5
S762PMT-10	Straight Union	5
S762PMT-2*	Straight Union	10
S762PMT-3*	Straight Union	5
S762PMT-4	Straight Union	10
S762PMT-532	Straight Union	10
S762PMT-6	Straight Union	10
S762PMT-8	Straight Union	10
S764PMT-4	Union Tee	10
S768PMT-2-1*	Male Connector	5
S768PMT-2-2*	Male Connector	5
S768PMT-532-1	Male Connector	5
S768PMT-532-2	Male Connector	5
S768PMT-4-2	Male Connector	10
S768PMT-4-4	Male Connector	10
S768PMT-4-6	Male Connector	5
S768PMT-6-2	Male Connector	5
S768PMT-6-4	Male Connector	10
S768PMT-6-6	Male Connector	10
S768PMT-6-8	Male Connector	5
S768PMT-8-4	Male Connector	5
S768PMT-8-6	Male Connector	5
S768PMT-8-8	Male Connector	5
S768PMT-10-8	Male Connector	5
S769PMT-2-2*	Male Swivel Elbow	5
S769PMT-532-2	Male Swivel Elbow	5
S769PMT-4-2	Male Swivel Elbow	10
S769PMT-4-4	Male Swivel Elbow	10
S769PMT-4-6	Male Swivel Elbow	5
S769PMT-6-4	Male Swivel Elbow	10
S769PMT-6-6	Male Swivel Elbow	10
S769PMT-6-8	Male Swivel Elbow	5
S769PMT-8-4	Male Swivel Elbow	5
S769PMT-8-8	Male Swivel Elbow	5
S772PMT-6-4	Male Swivel Branch Tee	5

* Non-DOT

BIN ASSORTMENTS CONT.

- Assortments Feature a Broad Selection of the Most Popular Fittings or Fasteners
- Each Assortment is Supplied with its Own Set of Labels which Include Image, Size & Part Number
- Receive a **Free Storage Bin** (424305) with Each Assortment Order!
- Assortments Also Include a Fitting Reorder Form and Bin Layout Diagram

BIN ASSORTMENT 424319

Brass Push-to-Connect Fittings

P/N	DESCRIPTION	QTY
S254PMT-4-2	45° Swivel Male Elbow	5
S254PMT-6-4	45° Swivel Male Elbow	5
S254PMT-6-6	45° Swivel Male Elbow	5
S254PMT-8-8	45° Swivel Male Elbow	5
S264PMT-4	Union Tee	5
S264PMT-6	Union Tee	5
S269PMT-2-2	90° Swivel Male Elbow	5
S269PMT-532-2	90° Swivel Male Elbow	5
S269PMT-4-2	90° Swivel Male Elbow	5
S269PMT-4-4	90° Swivel Male Elbow	5
S269PMT-4-6	90° Swivel Male Elbow	5
S269PMT-6-2	90° Swivel Male Elbow	10
S269PMT-6-4	90° Swivel Male Elbow	5
S269PMT-6-6	90° Swivel Male Elbow	5
S269PMT-6-8	90° Swivel Male Elbow	5
S269PMT-8-4	90° Swivel Male Elbow	5
S269PMT-8-6	90° Swivel Male Elbow	5
S269PMT-8-8	90° Swivel Male Elbow	10
S272PMT-6-4	Swivel Male Branch Tee	5
S272PMT-6-6	Swivel Male Branch Tee	5
S62PMT-532	Union Connector	5
S62PMT-3	Union Connector	5
S62PMT-4	Union Connector	5
S62PMT-6	Union Connector	5
S62PMT-8	Union Connector	5
S62PMT-12	Union Connector	5
S62PMT-10	Union Connector	5
S68PMT-10-8	Male Connector	5
S68PMT-4-2	Male Connector	5
S68PMT-4-4	Male Connector	5
S68PMT-4-6	Male Connector	5
S68PMT-6-2	Male Connector	5
S68PMT-6-4	Male Connector	5
S68PMT-6-6	Male Connector	5
S68PMT-6-8	Male Connector	5
S68PMT-8-4	Male Connector	5
S68PMT-8-6	Male Connector	5
S68PMT-8-8	Male Connector	5
TG-DUL03413	PTC Fitting Removal Tool	1

BIN ASSORTMENT 424318

UNC Fasteners

P/N	DESCRIPTION	QTY
423238P	UNC Stover Toplock Nut	100
423239P	UNC Stover Toplock Nut	100
423240P	UNC Stover Toplock Nut	100
423241P	UNC Stover Toplock Nut	50
423242P	UNC Stover Toplock Nut	50
423200P	USS Flat Washer	50
423201P	USS Flat Washer	50
423202P	USS Flat Washer	50
423203P	USS Flat Washer	25
423204P	USS Flat Washer	25
423000P	UNC Hex-Head Cap Screw	100
423004P	UNC Hex-Head Cap Screw	100
423005P	UNC Hex-Head Cap Screw	100
423006P	UNC Hex-Head Cap Screw	100
423008P	UNC Hex-Head Cap Screw	100
423023P	UNC Hex-Head Cap Screw	100
423025P	UNC Hex-Head Cap Screw	100
423026P	UNC Hex-Head Cap Screw	100
423027P	UNC Hex-Head Cap Screw	100
423029P	UNC Hex-Head Cap Screw	100
423046P	UNC Hex-Head Cap Screw	100
423047P	UNC Hex-Head Cap Screw	100
423048P	UNC Hex-Head Cap Screw	100
423050P	UNC Hex-Head Cap Screw	100
423052P	UNC Hex-Head Cap Screw	50
423064P	UNC Hex-Head Cap Screw	50
423065P	UNC Hex-Head Cap Screw	50
423066P	UNC Hex-Head Cap Screw	50
423068P	UNC Hex-Head Cap Screw	50
423072P	UNC Hex-Head Cap Screw	50
423083P	UNC Hex-Head Cap Screw	50
423085P	UNC Hex-Head Cap Screw	50
423087P	UNC Hex-Head Cap Screw	50
423089P	UNC Hex-Head Cap Screw	50
423091P	UNC Hex-Head Cap Screw	50

STORAGE BIN

- Sturdy Metal Storage Bin
- 40 Spaces: 5 Rows of 8
- Hemmed and Ribbed Dividers
- Ideal for Use with Brass Fittings
- Bin and Base Sold Separately



P/N	DESCRIPTION	WIDTH	HEIGHT	DEPTH
424305	Storage Bin	33-3/4"	22-1/2"	12"
424306	Bin Base	35-1/2"	6"	12-1/4"

CARDBOARD DISPLAY BOXES

- Great for Organizing Small Parts
- Fits on a Standard 10" and 12"
- Heavy Duty Cardboard for Extended Life



P/N	DESCRIPTION	WIDTH	HEIGHT	DEPTH
424176	Bin Box	4"	4-1/2"	9"
424177	Bin Box	6"	4-1/2"	9"



FASTENERS

Hex Head Cap Screws, Nuts, and Washers

PRODUCT FEATURES

- Coarse & Fine Thread Fasteners
- Grade 8
- Corrosion Resistant Finishes
- Meets Standards
- Convenient Standard Packaging
- Sold in Packaged Quantities Only

STANDARD COMPLIANCE

Meets ASME B18.2.1

HEX HEAD CAP SCREWS

- Coarse & Fine Thread
- Material Grade 8 Alloy per SAE J429
- Zinc Yellow CR+6
- Specification: ASME B18.2.1



1/4" HEX HEAD CAP SCREWS

COARSE	FINE	DIAMETER	LENGTH
423000P	424000P	1/4"	1/2"
423001P	424001P	1/4"	5/8"
423002P	424002P	1/4"	3/4"
423003P	424003P	1/4"	7/8"
423004P	424004P	1/4"	1"
423005P	424005P	1/4"	1-1/4"
423006P	424006P	1/4"	1-1/2"
423007P	424007P	1/4"	1-3/4"
423008P	424008P	1/4"	2"
423009P	424009P	1/4"	2-1/4"
423010P	424010P	1/4"	2-1/2"
423011P	424011P	1/4"	2-3/4"
423012P	424012P	1/4"	3"
423013P	424013P	1/4"	3-1/4"
423014P	424014P	1/4"	3-1/2"
423015P	424015P	1/4"	3-3/4"
423016P	424016P	1/4"	4"
423017P	424017P	1/4"	4-1/2"
423018P	424018P	1/4"	5"
423019P	424019P	1/4"	5-1/2"
423020P	424020P	1/4"	6"



5/16" HEX HEAD CAP SCREWS

COARSE	FINE	DIAMETER	LENGTH
423021P	424021P	5/16"	1/2"
423022P	424022P	5/16"	5/8"
423023P	424023P	5/16"	3/4"
423024P	424024P	5/16"	7/8"
423025P	424025P	5/16"	1"
423026P	424026P	5/16"	1-1/4"
423027P	424027P	5/16"	1-1/2"
423028P	424028P	5/16"	1-3/4"
423029P	424029P	5/16"	2"
423030P	424030P	5/16"	2-1/4"
423031P	424031P	5/16"	2-1/2"
423032P	424032P	5/16"	2-3/4"
423033P	424033P	5/16"	3"
423034P	424034P	5/16"	3-1/4"
423035P	424035P	5/16"	3-1/2"
423036P	424036P	5/16"	3-3/4"
423037P	424037P	5/16"	4"
423038P	424038P	5/16"	4-1/2"
423039P	424039P	5/16"	5"
423040P	424040P	5/16"	5-1/2"
423041P	424041P	5/16"	6"

3/8" HEX HEAD CAP SCREWS

COARSE	FINE	DIAMETER	LENGTH
423042P	424042P	3/8"	1/2"
423043P	424043P	3/8"	5/8"
423044P	424044P	3/8"	3/4"
423045P	424045P	3/8"	7/8"
423046P	424046P	3/8"	1"
423047P	424047P	3/8"	1-1/4"
423048P	424048P	3/8"	1-1/2"
423049P	424049P	3/8"	1-3/4"
423050P	424050P	3/8"	2"
423051P	424051P	3/8"	2-1/4"
423052P	424052P	3/8"	2-1/2"
423053P	424053P	3/8"	2-3/4"
423054P	424054P	3/8"	3"
423055P	424055P	3/8"	3-1/4"
423056P	424056P	3/8"	3-1/2"
423057P	424057P	3/8"	3-3/4"
423058P	424058P	3/8"	4"
423059P	424059P	3/8"	4-1/2"
423060P	424060P	3/8"	5"
423061P	424061P	3/8"	5-1/2"
423062P	424062P	3/8"	6"

7/16" HEX HEAD CAP SCREWS

COARSE	FINE	DIAMETER	LENGTH
423063P	424063P	7/16"	3/4"
423064P	424064P	7/16"	1"
423065P	424065P	7/16"	1-1/4"
423066P	424066P	7/16"	1-1/2"
423067P	424067P	7/16"	1-3/4"
423068P	424068P	7/16"	2"
423069P	424069P	7/16"	2-1/4"
423070P	424070P	7/16"	2-1/2"
423071P	424071P	7/16"	2-3/4"
423072P	424072P	7/16"	3"
423073P	424073P	7/16"	3-1/4"
423074P	424074P	7/16"	3-1/2"
423075P	424075P	7/16"	3-3/4"
423076P	424076P	7/16"	4"
423077P	424077P	7/16"	4-1/2"
423078P	424078P	7/16"	5"
423079P	424079P	7/16"	5-1/2"
423080P	424080P	7/16"	6"

1/2" HEX HEAD CAP SCREW

COARSE	FINE	DIAMETER	LENGTH
423081P	424081P	1/2"	3/4"
423082P	424082P	1/2"	7/8"
423083P	424083P	1/2"	1"
423084P	424084P	1/2"	1-1/4"
423085P	424085P	1/2"	1-1/2"
423086P	424086P	1/2"	1-3/4"
423087P	424087P	1/2"	2"
423088P	424088P	1/2"	2-1/4"
423089P	424089P	1/2"	2-1/2"
423090P	424090P	1/2"	2-3/4"
423091P	424091P	1/2"	3"
423092P	424092P	1/2"	3-1/4"
423093P	424093P	1/2"	3-1/2"
423094P	424094P	1/2"	3-3/4"
423095P	424095P	1/2"	4"
423096P	424096P	1/2"	4-1/2"
423097P	424097P	1/2"	5"
423098P	424098P	1/2"	5-1/2"
423099P	424099P	1/2"	6"

9/16" HEX HEAD CAP SCREW

COARSE	FINE	DIAMETER	LENGTH
423100P	424100P	9/16"	1"
423101P	424101P	9/16"	1-1/4"
423102P	424102P	9/16"	1-1/2"
423103P	424103P	9/16"	1-3/4"
423104P	424104P	9/16"	2"
423105P	424105P	9/16"	2-1/4"
423106P	424106P	9/16"	2-1/2"
423107P	424107P	9/16"	2-3/4"
423108P	424108P	9/16"	3"
423109P	424109P	9/16"	3-1/4"
423110P	424110P	9/16"	3-1/2"
423111P	424111P	9/16"	3-3/4"
423112P	424112P	9/16"	4"
423113P	424113P	9/16"	4-1/2"
423114P	424114P	9/16"	5"
423115P	424115P	9/16"	5-1/2"
423116P	424116P	9/16"	6"

5/8" HEX HEAD CAP SCREW

COARSE	FINE	DIAMETER	LENGTH
423117P	424117P	5/8"	1"
423118P	424118P	5/8"	1-1/4"
423119P	424119P	5/8"	1-1/2"
423120P	424120P	5/8"	1-3/4"
423121P	424121P	5/8"	2"
423122P	424122P	5/8"	2-1/4"
423123P	424123P	5/8"	2-1/2"
423124P	424124P	5/8"	2-3/4"
423125P	424125P	5/8"	3"
423126P	424126P	5/8"	3-1/4"
423127P	424127P	5/8"	3-1/2"
423128P	424128P	5/8"	3-3/4"
423129P	424129P	5/8"	4"
423130P	424130P	5/8"	4-1/2"
423131P	424131P	5/8"	5"
423132P	424132P	5/8"	5-1/2"
423133P	424133P	5/8"	6"

3/4" HEX HEAD CAP SCREW

COARSE	FINE	DIAMETER	LENGTH
423134P	424134P	3/4"	1"
423135P	424135P	3/4"	1-1/4"
423136P	424136P	3/4"	1-1/2"
423137P	424137P	3/4"	1-3/4"
423138P	424138P	3/4"	2"
423139P	424139P	3/4"	2-1/4"
423140P	424140P	3/4"	2-1/2"
423141P	424141P	3/4"	2-3/4"
423142P	424142P	3/4"	3"

COARSE	FINE	DIAMETER	LENGTH
423143P	424143P	3/4"	3-1/4"
423144P	424144P	3/4"	3-1/2"
423145P	424145P	3/4"	3-3/4"
423146P	424146P	3/4"	4"
423147P	424147P	3/4"	4-1/2"
423148P	424148P	3/4"	5"
423149P	424149P	3/4"	5-1/2"
423150P	424150P	3/4"	6"

FINISHED HEX NUTS

Finished hex nut provides adequate strength for many different types of common applications.

- Coarse & Fine Thread
- Zinc & Yellow CR+6
- Medium-Carbon
- Specification: ASME B18.2.2-2010
- Grade 8 Material



COARSE P/N	FINE P/N	BOLT SIZE	ACROSS FLATS	HEIGHT
423220P	424220P	1/4"	7/16"	7/32"
423221P	424221P	5/16"	1/2"	17/64"
423222P	424222P	3/8"	9/16"	21/64"
423223P	424223P	7/16"	11/16"	3/8"
423224P	424224P	1/2"	3/4"	7/16"
423225P	424225P	9/16"	7/8"	31/64"
423226P	424226P	5/8"	15/16"	35/64"
423227P	424227P	3/4"	1-1/8"	3/4"

AUTOMATION LOCKNUTS

Known as all-metal Grade C Toplock, Stover®, Oval Lock, Unitorque® and Cone Top.

The cone shaped top allows for automated, high-speed assembly with less temperature limitations. This type of nut is used when a reusable, rugged, one-piece construction locknut is required.

- Zinc CR+3
- Specification: ASME B18.16.6-2014
- Coarse & Fine Thread



COARSE P/N	FINE P/N	BOLT SIZE	ACROSS FLATS	HEIGHT
423238P	424238P	1/4"	7/16"	7/32"
423239P	424239P	5/16"	1/2"	17/64"
423240P	424240P	3/8"	9/16"	21/64"
423241P	424241P	7/16"	11/16"	3/8"
423242P	424242P	1/2"	3/4"	7/16"
423243P	424243P	9/16"	7/8"	31/64"
423244P	424244P	5/8"	15/16"	35/64"
423245P	424245P	3/4"	1-1/8"	3/4"

NYLON LOCKNUT

- Ideal for Applications with Vibration
- High Tensile Grade 8 Applications
- Specification: ASME B18.16.6-2014
- Zinc & Yellow CR+6
- Coarse & Fine Thread
- Nylon is Limited to 250°F



COARSE P/N	FINE P/N	BOLT SIZE
423247P	424247P	1/4"
423248P	424248P	5/16"
423249P	424249P	3/8"
423250P	424250P	7/16"
423251P	424251P	1/2"
423252P	424252P	9/16"
423253P	424253P	5/8"
423254P	424254P	3/4"

HEX NYLON INSERT FLANGE LOCKNUT

- Coarse Thread
- Ideal for Uneven Surfaces while Offering a Locking Element
- Zinc & Yellow CR+6
- Specification: ASME B18.16.6-2014
- Nylon is Limited to 250°F



P/N	BOLT SIZE
423255P	1/4"
423256P	5/16"
423257P	3/8"
423258P	7/16"
423259P	1/2"
423261P	5/8"
423262P	3/4"

FLAT WASHERS

- The Heat-Treated, Through-Hardened Washers Will Not Dish, Gall or Bend Under High Pressure or Stress
- These Washers Protect the Surface, Produce Better Clamping Force & Increase the Bearing Surface
- Mechanical Yellow Zinc Finish Protects Against Rust & Corrosion, Controls the Installation Torque Tension Relationship & Greatly Reduces Hydrogen Embrittlement

- For Use with Grade 8 & 5 Fastener Components
- Complies with ASTM F436 Standard Specification



P/N	STYLE	BOLT SIZE	O.D.	I.D.	THICKNESS
423200P	USS	1/4"	47/64"	5/16"	.051/.080"
423201P	USS	5/16"	7/8"	3/8"	.064/.104"
423202P	USS	3/8"	1"	7/16"	.064/.104"
423203P	USS	7/16"	1-1/4"	1/2"	.064/.104"
423204P	USS	1/2"	1-3/8"	9/16"	.086/.132"
423205P	USS	9/16"	1-15/32"	5/8"	.086/.132"
423206P	USS	5/8"	1-3/4"	11/16"	.108/.160"
423207P	USS	3/4"	2"	13/16"	.122/.177"
424200P	SAE	1/4"	5/8"	9/32"	.051/.080"
424201P	SAE	5/16"	11/16"	11/32"	.051/.080"
424202P	SAE	3/8"	13/16"	13/32"	.051/.080"
424203P	SAE	7/16"	59/64"	15/32"	.051/.080"
424204P	SAE	1/2"	1-1/16"	17/32"	.074/.121"
424205P	SAE	9/16"	1-5/32"	19/32"	.074/.121"
424206P	SAE	5/8"	1-5/16"	21/32"	.074/.121"
424207P	SAE	3/4"	1-15/32"	13/16"	.108/.160"

SPLIT-LOCK WASHERS

- For Use with Grade 8 & 5 Fastener Components
- Meets ANSI B18.21.1 Specification
- Mechanical Yellow Zinc Finish Protects Against Rust & Corrosion, Controls the Installation Torque Tension Relationship & Greatly Reduces Hydrogen Embrittlement



P/N	STYLE	BOLT SIZE	O.D.	I.D.	THICKNESS
423210P	Split-Lock	1/4"	.489"	.255/.263"	.109"
423211P	Split-Lock	5/16"	.586"	.318/.328"	.125"
423212P	Split-Lock	3/8"	.683"	.382/.393"	.141"
423213P	Split-Lock	7/16"	.779"	.446/.459"	.156"
423214P	Split-Lock	1/2"	.873"	.509/.523"	.171"
423215P	Split-Lock	9/16"	.971"	.572/.587"	.188"
423216P	Split-Lock	5/8"	1.079"	.636/.653"	.203"
423217P	Split-Lock	3/4"	1.271"	.763/.783"	.234"

ONLINE RESOURCES: JUST A CLICK AWAY!

Visit Our Website tramecsloan.com to Take Advantage of All the Digital Resources at Your Disposal.

PRODUCT LITERATURE

We've made all our print materials available online for you to view & download any time. Browse our **extensive Fleet Sheet library**, which includes numerous sheets in Spanish and French. Plus: catalogs past and present, posters, and more!

FIND YOUR SALES REP

Are you ready to order? Looking for more product information? Whether you're in the United States, Canada, or Mexico, our **handy map** makes it easy to put you in contact with the sales rep for your area!

SIGN UP FOR OUR E-NEWSLETTER

You can sign up to receive **periodic updates** from Tramec Sloan. You'll be the first to see our seasonal highlights and hear about big announcements!

GET IN TOUCH

Our online forms and direct contact information make it a breeze to speak with our top-notch **Customer Service** team or have your specific issues addressed by **Product Support**. We're here for you!

EVENTS CALENDAR

Tramec Sloan traverses the country to exhibit at major **trade shows**, participate in **customer events**, and more. Check the calendar to see where we'll be next!

FOLLOW US ON TWITTER

Connect with us on Twitter and stay on top of the latest product announcements, company news, tips, contests, and more! [@tramecsloan](https://twitter.com/tramecsloan)



TRAMEC SLOAN'S LABEL MAKER

Our Online Tool for Creating Custom PDF Label Sets for Tramec Sloan Fittings & Fasteners: labels.tramecsloan.com

STANDARD OR CUSTOM LABEL DESIGN:

Use our **standard label design** and you can choose these custom options:

- Your Own Part Number List
- Predefined Part Number List
- Competitor Cross Reference Number

Choosing **custom labels** allows you to include exactly the information you need. Just drag & drop it all into place:

- Part Name, Size Info, and Image
- Upload Your Own Logo
- Tramec Sloan Part Number in Large or Small Size
- Competitor Cross Reference Number

Note: Please Contact Your Tramec Sloan Sales Rep or Customer Service for the Label Maker Password

PART NUMBER LISTS:

Don't want or need to set up your own part number list? We have provided **pre-set lists** that you can choose from! These include all of our fittings and fastener categories.

Create your own list by following these steps:

	A	B
1	Part Number	
2	S211-4	
3	S203-6	
4	S772AB-4-2	

- Create a new spreadsheet
- Use only Tramec Sloan part numbers without suffixes (such as "V", "P", or "C")
- List the part numbers in column "A" only
- Your spreadsheet MUST be saved as a **.CSV** file (This is a standard option in Excel)

PRINTING YOUR LABELS:

- Tramec Sloan's Label Maker creates **1" x 2-5/8" labels** (30 Labels per Sheet)
- **Print your labels at 100% or "Actual" size.** Do not use "Fit to Page", "Scale", or similar. This will cause mis-alignment. (You may need to click on "options" or "properties" to see this attribute.)
- All printers are different! We recommend a **printing a test page first** to ensure proper alignment before you print a large label set or multiple sets.



24"X36" BRASS POSTER

Available at No Cost for All Tramec Sloan Brass Customers! Poster Features All Our Fitting Families for Easy Reference. Add One to Your Order Today: Part Number LIT-PD-01



Brass Fittings



A - Fitting Image C - CMI P/N
 B - Tramec Sloan P/N D - Fitting Description
 Sizes are Defined by a Suffix Number Following the P/N Class. Ex: a 540-4 would have a 1/4" diameter.
 Fittings with multiple tube sizes use multiple suffixes. Ex: a 5120-0-6 has one 1/2" end and one 3/8" end.

SUFFIX	SIZE
0	1/16"
1	1/8"
2	3/16"
3	1/4"
4	5/16"
5	3/8"
6	1/2"
8	5/8"
10	3/4"
12	7/8"
14	1"
16	1 1/8"

Compression & Copper

Nylon & Rubber Hose

Pipe & Hose Barb

45° Flare Fittings

Push-On & Inverted Flare

Quick Connect & Standpipes

RUBBER AIR HOSE
 Sizes 3/8" to 1/2"
 Available in Black, Red & Blue

NYLON TUBING
 Sizes 1/8" to 3/4"
 Available in Black, Green, Blue, Yellow, Orange, Red & Purple

TRAMECSLOAN.COM | 800.336.7778

ELECTRICAL PRODUCTS

MANUFACTURING IN THE UNITED STATES

The tradition of quality, attention to detail and adherence to industry standards continues with our electrical products offering. You'll find the industry's top OEMs manufacturing with our receptacles and our MADE in the USA cables found in quality distributors across the map.

We are also not shy to innovate when challenged by our customers to find solutions. That's why products like the Smart Box[®] (page 228) and the Sonogrip[®] (page 206) were developed and became industry standards to the Heavy Duty Vehicle market.

In addition to receptacles and cables, you'll find we also have you covered on the many other electrical products that help keep you and your customers moving.

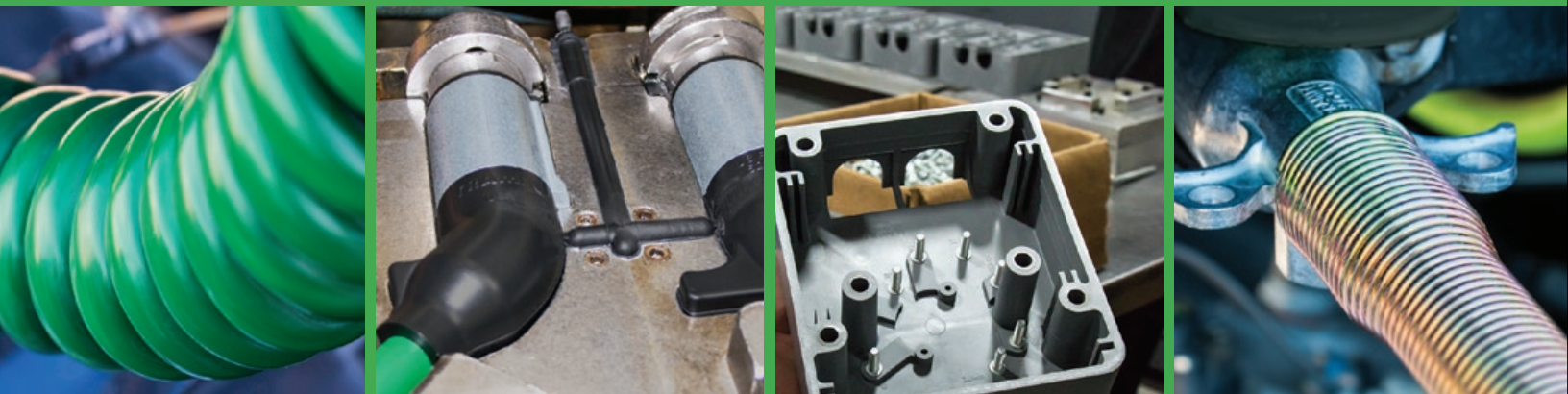

IN THIS SECTION:

PRODUCT	PAGE	
Sonogrip® ABS Cables	206	Bulk Wire & Cable
ABS Cables.....	212	Electrical Harnesses
Sonogrip® Standard Cables.....	216	Electrical Connectors.....
Standard Cables	218	Heat Shrink Tubing.....
Single & Dual Pole Cables	220	Battery Terminals.....
Plugs	224	Power Terminals.....
Smart Box® Receptacles	228	Power Lugs & Splices
30-Pin Receptacles	232	Battery Cables.....
Nylon Receptacles.....	233	Circuit Breakers
Zinc Receptacles.....	237	Fuses.....
Junction Boxes	241	Tools & Kits.....
		Switches & Toggles



CABLES

MANUFACTURING ELECTRICAL CABLES IN THE USA!

Tramec Sloan **designs & manufactures cables in the USA** at our facilities in Lola, Kansas and Holland, Michigan. We are able to provide cables for a wide variety of applications and with features that have numerous options including the cable jacket and plug bodies.



MANUFACTURING
IN THE U.S.A.



MEETS DOT & SAE
STANDARDS



CORROSION
RESISTANCE



HIGH QUALITY
COMPONENTS

THE ORIGINAL SONOGRIP® ABS



Tramec Sloan's Innovative Plug Features Numerous Anti-Corrosion Attributes that Result in a Superior, Longer-Lasting Cable

1. Stainless Steel Radial Springs & Split Terminals Provide the Best Long-Term Connection to Receptacle Pins
2. Terminals are **Ultrasonically Welded**, Eliminating Corrosion & Loosening at the Terminal-to-Wire Connection
3. Elastomeric Plug Body is **Solid-Molded** onto the Cable with Sealants to Exclude Moisture
4. Reinforced Nylon or Die-Cast Sleeve on Plug Provides Lasting Durability
5. The "Pistol Grip" Angled Plug Option Offers **Strain Relief** to the Higher Mounted Plug, Resulting in Longer Lasting Cables

6. Post-Plated Terminals Utilized for Maximum Corrosion Protection
 - Meets SAE J560 & J2222
 - Features a 3-Year Warranty

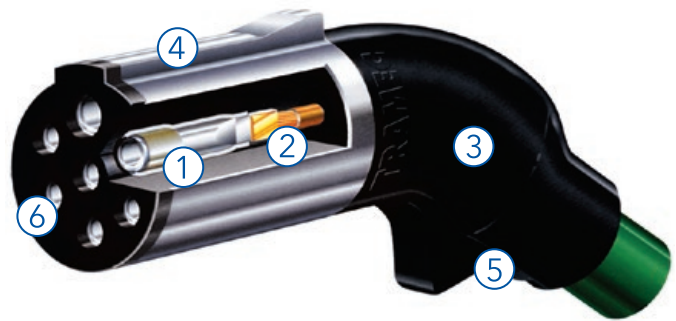

A TRAMEC SLOAN ORIGINAL!

A major fleet had approached Tramec Sloan looking for a cable that would:

- Eliminate Flickering Trailer Lights
- Be Resistant to the Effects of Water & Chemical Corrosion
- Ensure a Firm, Tight Plug Connection
- Have a Durable Plug that Can Stand the Abuse of Everyday Use

Our solution to these requirements is the Sonogrip! It improves on every aspect of the traditional ABS cable, resulting in superior, longer-lasting connections.





PICTURED:
Sonogrip Cable 4A112

SONOGRIP® ABS 1/8 - 2/10 - 4/12 COILED CABLES - HEAVY DUTY XT JACKET

- Our Sonogrip Cables are **Made in the USA** with Numerous Anti-Corrosion Features
- Don't See the Length You Need? Not a Problem! We Make Custom Cables to Your Specs!
- The Heavy Duty XT Jacket Provides **Superior** Cut, Tear & Abrasion Resistance. Plus, **Excellent** Coil Retention in Both Cold & Warm Weather Extremes
- Temperature Rated -60°F to 190°F

COILED SONOGRIP® ABS WITH XT JACKET - ZINC PLUGS

P/N	SLEEVE	TRACTOR PLUG	TRAILER PLUG	JACKET	LENGTH	LEADS
4A012	Zinc	Straight	Straight	Heavy Duty XT	12'	Two 12"
4A015	Zinc	Straight	Straight	Heavy Duty XT	15'	Two 12"
4A016	Zinc	Straight	Straight	Heavy Duty XT	15'	One 12" & One 72"
4A017	Zinc	Straight	Straight	Heavy Duty XT	15'	One 12" & One 48"
4A112	Zinc	Straight	Angled	Heavy Duty XT	12'	Two 12"
4A115	Zinc	Straight	Angled	Heavy Duty XT	15'	Two 12"
4A116	Zinc	Straight	Angled	Heavy Duty XT	15'	One 12" & One 72"
4A117	Zinc	Straight	Angled	Heavy Duty XT	15'	One 12" & One 48"

COILED SONOGRIP® ABS WITH XT JACKET - NYLON PLUGS

P/N	SLEEVE	TRACTOR PLUG	TRAILER PLUG	JACKET	LENGTH	LEADS
4AC12	Nylon	Straight	Straight	Heavy Duty XT	12'	Two 12"
4AC15	Nylon	Straight	Straight	Heavy Duty XT	15'	Two 12"
4AC16	Nylon	Straight	Straight	Heavy Duty XT	15'	One 12" & One 72"
4AC17	Nylon	Straight	Straight	Heavy Duty XT	15'	One 12" & One 48"
4AD12	Nylon	Straight	Angled	Heavy Duty XT	12'	Two 12"
4AD15	Nylon	Straight	Angled	Heavy Duty XT	15'	Two 12"
4AD16	Nylon	Straight	Angled	Heavy Duty XT	15'	One 12" & One 72"
4AD17	Nylon	Straight	Angled	Heavy Duty XT	15'	One 12" & One 48"



PICTURED:
Sonogrip Cable 4D017

SONOGRIP® ABS 1/8 - 2/10 - 4/12 COILED CABLES - STANDARD JACKET

- Our Sonogrip Cables are **Made in the USA** with Numerous Anti-Corrosion Features
- Don't See the Length You Need? Not a Problem! We Make Custom Cables to Your Specs!
- The Standard Jacket Provides **Good** Cut, Tear & Abrasion Resistance. Plus, **Good** Coil Retention in Both Cold & Warm Weather Extremes
- Temperature Rated -60°F to 190°F

COILED SONOGRIP® ABS WITH STANDARD JACKET - ZINC PLUGS

P/N	SLEEVE	TRACTOR PLUG	TRAILER PLUG	JACKET	LENGTH	LEADS
4D012	Zinc	Straight	Straight	ABS Green	12'	Two 12"
4D015	Zinc	Straight	Straight	ABS Green	15'	Two 12"
4D016	Zinc	Straight	Straight	ABS Green	15'	One 12" & One 72"
4D017	Zinc	Straight	Straight	ABS Green	15'	One 12" & One 48"
4D112	Zinc	Straight	Angled	ABS Green	12'	Two 12"
4D115	Zinc	Straight	Angled	ABS Green	15'	Two 12"
4D116	Zinc	Straight	Angled	ABS Green	15'	One 12" & One 72"
4D117	Zinc	Straight	Angled	ABS Green	15'	One 12" & One 48"

COILED SONOGRIP® ABS WITH STANDARD JACKET - NYLON PLUGS

P/N	SLEEVE	TRACTOR PLUG	TRAILER PLUG	JACKET	LENGTH	LEADS
4DC12	Nylon	Straight	Straight	ABS Green	12'	Two 12"
4DC15	Nylon	Straight	Straight	ABS Green	15'	Two 12"
4DC16	Nylon	Straight	Straight	ABS Green	15'	One 12" & One 72"
4DC17	Nylon	Straight	Straight	ABS Green	15'	One 12" & One 48"
4DD12	Nylon	Straight	Angled	ABS Green	12'	Two 12"
4DD15	Nylon	Straight	Angled	ABS Green	15'	Two 12"
4DD16	Nylon	Straight	Angled	ABS Green	15'	One 12" & One 72"
4DD17	Nylon	Straight	Angled	ABS Green	15'	One 12" & One 48"

PICTURED:
Sonogrip Cable 4B015



SONOGRIP® ABS 1/8 - 2/10 - 4/12 COILED CABLES - HEAVY DUTY XT JACKET

- Our Sonogrip Cables are **Made in the USA** with Numerous Anti-Corrosion Features
- Don't See the Length You Need? Not a Problem! We Make Custom Cables to Your Specs!
- The Heavy Duty XT Jacket Provides **Superior** Cut, Tear & Abrasion Resistance. Plus, **Excellent** Coil Retention in Both Cold & Warm Weather Extremes
- Temperature Rated -60°F to 190°F

STRAIGHT SONOGRIP® ABS WITH XT JACKET - ZINC PLUGS

P/N	SLEEVE	TRACTOR PLUG	TRAILER PLUG	JACKET	LENGTH
4B012	Zinc	Straight	Straight	Heavy Duty XT	12'
4B015	Zinc	Straight	Straight	Heavy Duty XT	15'
4B020	Zinc	Straight	Straight	Heavy Duty XT	20'
4B112	Zinc	Straight	Angled	Heavy Duty XT	12'
4B115	Zinc	Straight	Angled	Heavy Duty XT	15'
4B120	Zinc	Straight	Angled	Heavy Duty XT	20'

STRAIGHT SONOGRIP® ABS WITH XT JACKET - NYLON PLUGS

P/N	SLEEVE	TRACTOR PLUG	TRAILER PLUG	JACKET	LENGTH
4BC12	Nylon	Straight	Straight	Heavy Duty XT	12'
4BC15	Nylon	Straight	Straight	Heavy Duty XT	15'
4BC20	Nylon	Straight	Straight	Heavy Duty XT	20'
4BD12	Nylon	Straight	Angled	Heavy Duty XT	12'
4BD15	Nylon	Straight	Angled	Heavy Duty XT	15'
4BD20	Nylon	Straight	Angled	Heavy Duty XT	20'

PICTURED:
Sonogrip Cable 4CD15



SONOGRIP® ABS 1/8 - 2/10 - 4/12 COILED CABLES - STANDARD JACKET

- Our Sonogrip Cables are **Made in the USA** with Numerous Anti-Corrosion Features
- Don't See the Length You Need? Not a Problem! We Make Custom Cables to Your Specs!
- The Standard Jacket Provides **Good** Cut, Tear & Abrasion Resistance.
- Temperature Rated -60°F to 190°F

STRAIGHT SONOGRIP® ABS WITH STANDARD JACKET - ZINC PLUGS

P/N	SLEEVE	TRACTOR PLUG	TRAILER PLUG	JACKET	LENGTH
4C012	Zinc	Straight	Straight	Standard ABS Green	12'
4C015	Zinc	Straight	Straight	Standard ABS Green	15'
4C020	Zinc	Straight	Straight	Standard ABS Green	20'
4C112	Zinc	Straight	Angled	Standard ABS Green	12'
4C115	Zinc	Straight	Angled	Standard ABS Green	15'
4C120	Zinc	Straight	Angled	Standard ABS Green	20'

STRAIGHT SONOGRIP® ABS WITH STANDARD JACKET - NYLON PLUGS

P/N	SLEEVE	TRACTOR PLUG	TRAILER PLUG	JACKET	LENGTH
4CC12	Nylon	Straight	Straight	Standard ABS Green	12'
4CC15	Nylon	Straight	Straight	Standard ABS Green	15'
4CC20	Nylon	Straight	Straight	Standard ABS Green	20'
4CD12	Nylon	Straight	Angled	Standard ABS Green	12'
4CD15	Nylon	Straight	Angled	Standard ABS Green	15'
4CD20	Nylon	Straight	Angled	Standard ABS Green	20'

AMERICAN MADE ABS & STANDARD CABLES

Tramec Sloan's Electrical Cables are Made in the USA and are Designed with Features to Keep You on the Road Longer

- Copper Content is 10% Greater than SAE J1128 Requires Resulting in Better Flexibility and Connectivity
- All ABS, ISO, and Standard Cables with Zinc Plugs Utilize Our **Premium Spring Guard** which are Tightly Wound and have a Yellow Zinc Dichromate Finish for Extra Corrosion Protection. Plus, Integrated Loop for Easy Hang Up
- All Cables Use Plated Brass Terminals for Excellent Corrosion Resistance
- Terminals are **Double Crimped** to the Wire to Provide Strain Relief & Vibration-Proof Connections
- Wire Meets SAE J2394 Specs
- Temp. Rated -60°F to 190°F
- The Heavy Duty XT Jacket Provides **Superior** Cut, Tear & Abrasion Resistance. Plus, **Excellent** Coil Retention in Both Cold & Warm Weather Extremes
- The Standard Jacket Provides **Good** Cut, Tear & Abrasion Resistance. Plus, **Good** Coil Retention in Both Cold & Warm Weather Extremes

Double Crimped Terminals

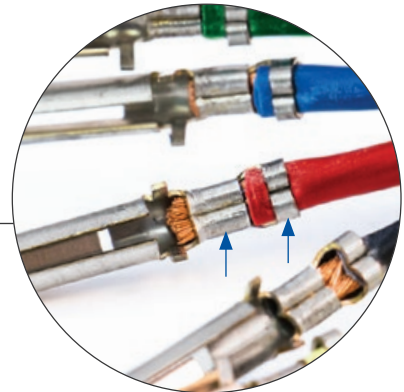

Our Premium Spring

Their Spring



Don't See the Length or Configuration You Need? Not a Problem!

We Make Custom Cables to Your Specs.
Just Contact Your Tramec Sloan Rep or Customer Service to Order.



PICTURED:
ABS Cable 4AA15



PICTURED:
ABS Cable 4CA12

HEAVY DUTY ABS CABLES WITH ZINC PLUGS

- **Made in the USA**
- Cable Made with 10% Greater Copper Content for Better Flexibility and Connectivity
- Features Premium Spring Guards
- Plated Brass Terminals are Double Crimped
- XT Jacket Provides **Superior** Durability and **Excellent** Coil Retention
- Standard Jacket Provides **Good** Durability and **Good** Coil Retention
- Temp. Rated -60°F to 190°F

ABS CABLES WITH ZINC PLUGS - XT JACKET

P/N	CABLE STYLE	PLUGS	JACKET	LENGTH	LEADS
4AA12	Coiled	7-Way Zinc Plugs	Heavy Duty XT	12'	Two 12"
4AA15	Coiled	7-Way Zinc Plugs	Heavy Duty XT	15'	Two 12"
4AA16	Coiled	7-Way Zinc Plugs	Heavy Duty XT	15'	One 12" & One 72"
4AA17	Coiled	7-Way Zinc Plugs	Heavy Duty XT	15'	One 12" & One 48"
4BA12	Straight	7-Way Zinc Plugs	Heavy Duty XT	12'	-
4BA15	Straight	7-Way Zinc Plugs	Heavy Duty XT	15'	-
4BA20	Straight	7-Way Zinc Plugs	Heavy Duty XT	20'	-

ABS CABLES WITH ZINC PLUGS - STANDARD JACKET

P/N	CABLE STYLE	PLUGS	JACKET	LENGTH	LEADS
4DA12	Coiled	7-Way Zinc Plugs	Standard ABS Green	12'	Two 12"
4DA15	Coiled	7-Way Zinc Plugs	Standard ABS Green	15'	Two 12"
4DA16	Coiled	7-Way Zinc Plugs	Standard ABS Green	15'	One 12" & One 72"
4DA17	Coiled	7-Way Zinc Plugs	Standard ABS Green	15'	One 12" & One 48"
4CA12	Straight	7-Way Zinc Plugs	Standard ABS Green	12'	-
4CA15	Straight	7-Way Zinc Plugs	Standard ABS Green	15'	-
4CA20	Straight	7-Way Zinc Plugs	Standard ABS Green	20'	-



HEAVY DUTY ABS CABLES WITH NYLON PLUGS - STANDARD JACKET

- **Made in the USA!**
- Cable Made with 10% Greater Copper Content for Better Flexibility and Connectivity
- Field Replaceable Plug
- Plated Brass Terminals are Double Crimped to the Wire
- Standard Jacket Provides **Good** Cut, Tear & Abrasion Resistance
- **Good** Coil Retention in Both Cold & Warm Weather Extremes
- Temp. Rated -60°F to 190°F

P/N	CABLE STYLE	JACKET	LENGTH	LEADS
421156	Coiled	Standard ABS Green	12'	Two 12"
421157	Coiled	Standard ABS Green	15'	Two 12"
421203	Coiled	Standard ABS Green	15'	One 12" & One 48"
421201	Straight	Standard ABS Green	10'	-
421202	Straight	Standard ABS Green	12'	-
421200	Straight	Standard ABS Green	15'	-



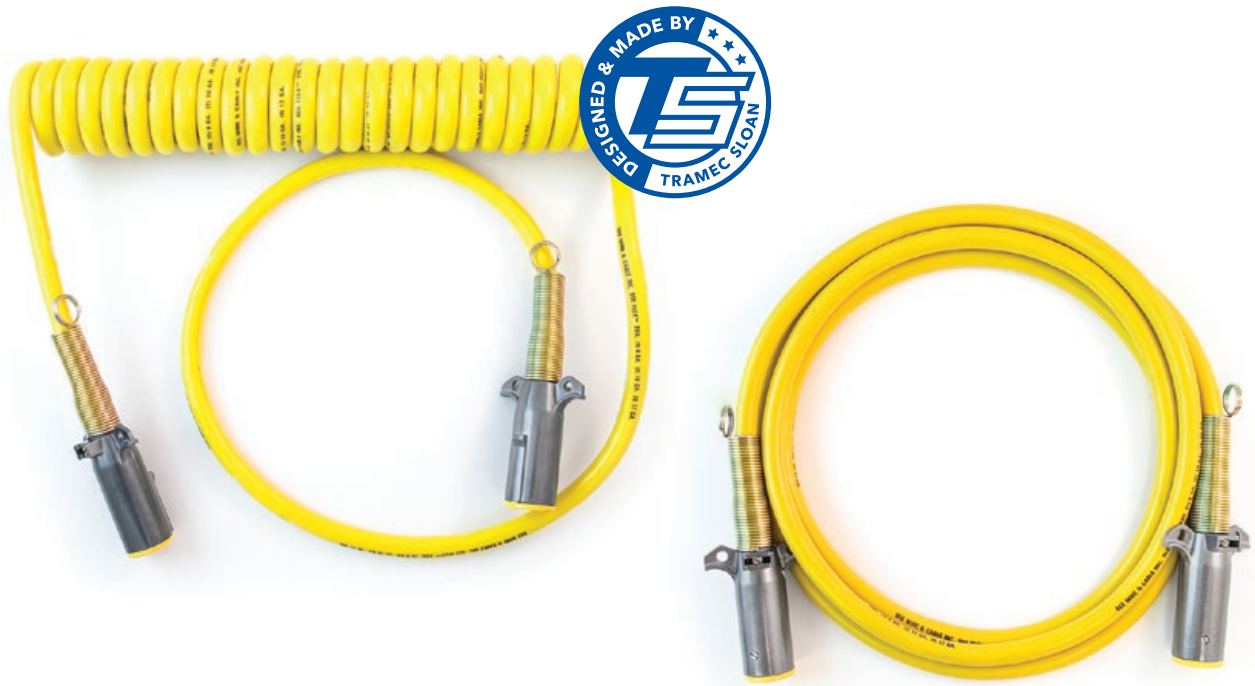

ISO/AUXILIARY CABLES WITH ZINC PLUGS

- **Made in the USA!**
- Meets ISO 3731 & SAE 2394 Specifications
- Premium Spring Guards
- Plated Brass Terminals are Double Crimped to the Wire
- Jacket Provides **Good** Cut, Tear & Abrasion Resistance
- **Good** Coil Retention in Both Cold & Warm Weather Extremes
- Temp. Rated -60°F to 190°F

P/N	CABLE STYLE	JACKET	LENGTH	LEADS
421159	Coiled	ISO Yellow	12'	Two 12"
421160	Coiled	ISO Yellow	15'	Two 12"
421214	Coiled	ISO Yellow	15'	One 12" & One 72"
421215	Coiled	ISO Yellow	15'	One 12" & One 48"
421213	Straight	ISO Yellow	10'	-
421178	Straight	ISO Yellow	12'	-
421179	Straight	ISO Yellow	15'	-

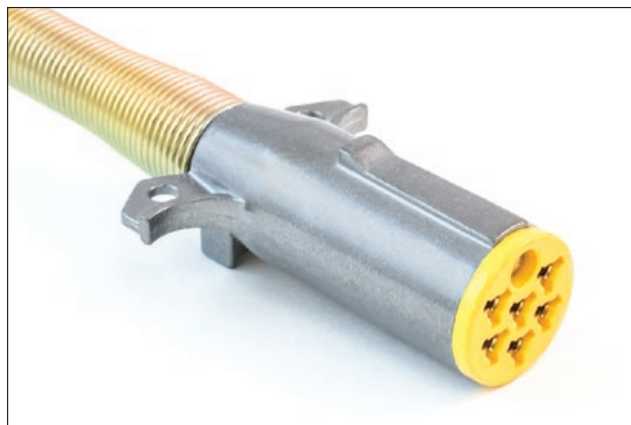



PICTURED:
Sonogrip Cable 45115

STANDARD COILED SONOGRIP® CABLES WITH ZINC PLUGS

- Our Sonogrip Cables are **Made in the USA** with Numerous Anti-Corrosion Features
- Don't See the Length You Need? Not a Problem! We Make Custom Cables to Your Specs!
- The Standard Jacket Provides **Good** Cut, Tear & Abrasion Resistance. Plus, **Good** Coil Retention in Both Cold & Warm Weather Extremes
- Temperature Rated -60°F to 190°F

COILED STANDARD SONOGRIP® CABLES - 1/10-6/12 GA WIRE

P/N	SLEEVE	TRACTOR PLUG	TRAILER PLUG	JACKET	LENGTH	LEADS
45012	Zinc	Straight	Straight	Standard Black	12'	Two 12"
45015	Zinc	Straight	Straight	Standard Black	15'	Two 12"
45016	Zinc	Straight	Straight	Standard Black	15'	One 12" & One 72"
45017	Zinc	Straight	Straight	Standard Black	15'	One 12" & One 48"
45112	Zinc	Straight	Angled	Standard Black	12'	Two 12"
45115	Zinc	Straight	Angled	Standard Black	15'	Two 12"
45116	Zinc	Straight	Angled	Standard Black	15'	One 12" & One 72"
45117	Zinc	Straight	Angled	Standard Black	15'	One 12" & One 48"

COILED STANDARD SONOGRIP® CABLES - 1/12-6/14 GA WIRE

P/N	SLEEVE	TRACTOR PLUG	TRAILER PLUG	JACKET	LENGTH	LEADS
47012	Zinc	Straight	Straight	Standard Black	12'	Two 12"
47015	Zinc	Straight	Straight	Standard Black	15'	Two 12"
47016	Zinc	Straight	Straight	Standard Black	15'	One 12" & One 72"
47017	Zinc	Straight	Straight	Standard Black	15'	One 12" & One 48"
47112	Zinc	Straight	Angled	Standard Black	12'	Two 12"
47115	Zinc	Straight	Angled	Standard Black	15'	Two 12"
47116	Zinc	Straight	Angled	Standard Black	15'	One 12" & One 72"
47117	Zinc	Straight	Angled	Standard Black	15'	One 12" & One 48"



PICTURED:
Sonogrip Cable 46015

STANDARD STRAIGHT SONOGRIP® CABLES WITH ZINC PLUGS

- Our Sonogrip Cables are **Made in the USA** with Numerous Anti-Corrosion Features
- Don't See the Length You Need? Not a Problem! We Make Custom Cables to Your Specs!
- The Standard Jacket Provides **Good** Cut, Tear & Abrasion Resistance.
- Temperature Rated -60°F to 190°F

STRAIGHT STANDARD SONOGRIP® CABLES - 1/10-6/12 GA WIRE

P/N	SLEEVE	TRACTOR PLUG	TRAILER PLUG	JACKET	LENGTH
46012	Zinc	Straight	Straight	Standard Black	12'
46015	Zinc	Straight	Straight	Standard Black	15'
46020	Zinc	Straight	Straight	Standard Black	20'
46112	Zinc	Straight	Angled	Standard Black	12'
46115	Zinc	Straight	Angled	Standard Black	15'
46120	Zinc	Straight	Angled	Standard Black	20'

STRAIGHT STANDARD SONOGRIP® CABLES - 1/12-6/14 GA WIRE

P/N	SLEEVE	TRACTOR PLUG	TRAILER PLUG	JACKET	LENGTH
48012	Zinc	Straight	Straight	Standard Black	12'
48015	Zinc	Straight	Straight	Standard Black	15'
48020	Zinc	Straight	Straight	Standard Black	20'
48112	Zinc	Straight	Angled	Standard Black	12'
48115	Zinc	Straight	Angled	Standard Black	15'
48120	Zinc	Straight	Angled	Standard Black	20'

PICTURED:
Standard Cable 47A15



STANDARD COILED CABLES WITH ZINC PLUGS

- **Made in the USA!**
- Ideal for Trailers that are Non-ABS Equipped
- Premium Spring Guard
- Plated Brass Terminals are Double Crimped to the Wire
- 10% Greater Copper Content for Flexibility & Connectivity
- Standard Jacket Provides **Good** Cut, Tear & Abrasion Resistance and **Good** Coil Retention
- Temp. Rated -60°F to 190°F

P/N	TRACTOR PLUG	TRAILER PLUG	JACKET	LENGTH	LEADS
45A12	7-Way Plug	7-Way Plug	1/10 - 6/12 GA , Black	12'	Two 12"
45A15	7-Way Plug	7-Way Plug	1/10 - 6/12 GA , Black	15'	Two 12"
45A16	7-Way Plug	7-Way Plug	1/10 - 6/12 GA , Black	15'	One 12" & One 72"
45A17	7-Way Plug	7-Way Plug	1/10 - 6/12 GA , Black	15'	One 12" & One 48"
47A12	7-Way Plug	7-Way Plug	1/12 - 6/14 GA , Black	12'	Two 12"
47A15	7-Way Plug	7-Way Plug	1/12 - 6/14 GA , Black	15'	Two 12"
47A16	7-Way Plug	7-Way Plug	1/12 - 6/14 GA , Black	15'	One 12" & One 72"
47A17	7-Way Plug	7-Way Plug	1/12 - 6/14 GA , Black	15'	One 12" & One 48"



PICTURED:
Standard Cable 46A15

STANDARD STRAIGHT CABLES WITH ZINC PLUGS

- **Made in the USA!**
- Ideal for Trailers that are Non-ABS Equipped
- Premium Spring Guard
- Plated Brass Terminals are Double Crimped to the Wire
- 10% Greater Copper Content for Flexibility & Connectivity
- Standard Jacket Provides **Good** Cut, Tear & Abrasion Resistance
- Temp. Rated -60°F to 190°F

P/N	TRACTOR PLUG	TRAILER PLUG	JACKET	LENGTH
46A12	7-Way Plug	7-Way Plug	1/10 - 6/12 GA , Black	12'
46A15	7-Way Plug	7-Way Plug	1/10 - 6/12 GA , Black	15'
46A20	7-Way Plug	7-Way Plug	1/10 - 6/12 GA , Black	20'
48A12	7-Way Plug	7-Way Plug	1/12 - 6/14 GA , Black	12'
48A15	7-Way Plug	7-Way Plug	1/12 - 6/14 GA , Black	15'
48A20	7-Way Plug	7-Way Plug	1/12 - 6/14 GA , Black	20'

SINGLE POLE LIFTGATE CABLES WITH ZINC PLUGS

- **Made in the USA!**
- Externally Grounded Single Pole Plugs
- Heavy Duty 4-Gauge, High Strand Count Cable
- Excellent Coil Memory and Durability
- Cable is Flexible Down to -85°F
- Cable Jacket is Resistant to Gasoline, Diesel Fuel and Commonly Used Chemicals
- Maximum Current Carrying Capacity 100 Amps for 12 Volt Intermittent Liftgate Use (200 AMP INTERMITTENT)



PICTURED:
Single Pole Cable 421146

DUAL POLE LIFTGATE CABLES WITH ZINC PLUGS

- **Made in the USA**
- Internally Grounded Horizontal and Vertical Dual Pole Plugs
- Heavy Duty 4 or 6-Gauge, High Strand Count Cable
- Excellent Coil Memory and Durability
- Cable is Flexible Down to -85°F
- Maximum Current Carrying Capacity 100 Amps for 12 Volt Intermittent Liftgate Use (200 AMP INTERMITTENT)
- Cable Jacket is Resistant to Gasoline, Diesel Fuel and Commonly Used Chemicals
- Bonded 2-Conductor Cable



Horizontal Dual Pole

Vertical Dual Pole

SINGLE POLE LIFTGATE CABLES - 4 GA

P/N	PLUGS	CABLE STYLE	LENGTH	LEADS
421145	Single Pole	Coiled	12'	Two 12"
421146	Single Pole	Coiled	15'	Two 12"
421236	Single Pole	Coiled	15'	One 12" & One 48"
421296	Single Pole	Straight	12'	-
421297	Single Pole	Straight	15'	-
421298	Single Pole	Straight	20'	-

HORIZONTAL DUAL POLE LIFTGATE CABLES - 4 GA

P/N	PLUGS	CABLE STYLE	LENGTH	LEADS
421172	Horizontal Dual Pole	Coiled	12'	Two 12"
421173	Horizontal Dual Pole	Coiled	15'	Two 12"
421309	Horizontal Dual Pole	Coiled	15'	One 12" & One 48"
421300	Horizontal Dual Pole	Straight	12'	-
421301	Horizontal Dual Pole	Straight	15'	-
421302	Horizontal Dual Pole	Straight	20'	-

VERTICAL DUAL POLE LIFTGATE CABLES - 4 GA

P/N	PLUGS	CABLE STYLE	LENGTH	LEADS
421327	Vertical Dual Pole	Coiled	12'	Two 12"
421328	Vertical Dual Pole	Coiled	15'	Two 12"
421329	Vertical Dual Pole	Coiled	15'	One 12" & One 48"
421330	Vertical Dual Pole	Straight	12'	-
421331	Vertical Dual Pole	Straight	15'	-
421332	Vertical Dual Pole	Straight	20'	-

VERTICAL DUAL POLE LIFTGATE CABLES - 6 GA

P/N	PLUGS	CABLE STYLE	LENGTH	LEADS
421333	Vertical Dual Pole	Coiled	12'	Two 12"
421334	Vertical Dual Pole	Coiled	15'	Two 12"
421335	Vertical Dual Pole	Coiled	15'	One 12" & One 48"
421336	Vertical Dual Pole	Straight	12'	-
421337	Vertical Dual Pole	Straight	15'	-
421338	Vertical Dual Pole	Straight	20'	-



PICTURED:
Single to Dual Pole
Cable 38183S12

SINGLE TO DUAL POLE LIFTGATE CABLES WITH ZINC PLUGS

- Ideal for Connecting Newer Vehicles with Dual Pole Receptacles to Older Trailers using Single Pole Receptacles
- **Made in the USA!**
- Externally Grounded Single Pole Plugs
- Internally Grounded Horizontal Dual Pole Plugs
- Heavy Duty 4-Gauge, High Strand Count Cable
- Excellent Coil Memory and Durability
- Cable is Flexible Down to -85°F
- Y-Ended Cable: One Cable with Two Connection Options! Great for Fleets Using Both Single & Dual Pole Connections
- Maximum Current Carrying Capacity 100 Amps for 12 Volt Intermittent Liftgate Use (200 AMP INTERMITTENT)
- Cable Jacket is Resistant to Gasoline, Diesel Fuel and Commonly Used Chemicals
- Bonded 2-Conductor Cable

P/N	PLUGS	CABLE STYLE	LENGTH	LEADS
38183-12	Single Pole to Horizontal Dual Pole	Coiled	12'	Two 12"
38183-15	Single Pole to Horizontal Dual Pole	Coiled	15'	Two 12"
38183-17	Single Pole to Horizontal Dual Pole	Coiled	15'	One 12" & One 48"
38183S12	Single Pole to Horizontal Dual Pole	Straight	12'	-
38183S15	Single Pole to Horizontal Dual Pole	Straight	15'	-
38184	Y-Ended: Horizontal Dual Pole to Single & Horizontal Dual Pole	Coiled	15'	One 12" & One 48"

PICTURED:
Y-Ended Cable 38184





PICTURED:
4-Way Cable 421193

4-WAY & 6-WAY COILED CABLES

- **Made in the USA!**
- Ideal for RVs, Utility & Boat Trailers, and Other Light Duty Towing Applications
- Plated Brass Terminals are Double Crimped to the Wire
- Cable Made with 10% Greater Copper Content for Better Flexibility and Connectivity
- Tightly-Wound Spring Guards with Hang-Up Loop
- All Cables Have Two 12" Leads
- Standard Jacket Provides **Good** Cut, Tear & Abrasion Resistance
- **Good** Coil Retention in Both Cold & Warm Weather Extremes
- Temp. Rated -60°F to 190°F

4-WAY (4-14 GA) CABLES

P/N	LENGTH	PLUGS
421198	6'	Two Zinc Plugs
421197	8'	One Zinc Plug
421181	8'	Two Zinc Plugs
421196	10'	One Zinc Plug
421195	10'	Two Zinc Plugs
421194	12'	One Zinc Plug
421182	12'	Two Zinc Plugs
421193	15'	Two Zinc Plugs

6-WAY (6-14 GA) CABLES

P/N	LENGTH	PLUGS
421192	6'	One Zinc Plug
421191	6'	Two Zinc Plugs
421190	8'	One Zinc Plug
421183	8'	Two Zinc Plugs
421189	10'	One Zinc Plug
421188	10'	Two Zinc Plugs
421184	12'	Two Zinc Plugs
421187	15'	Two Zinc Plugs

TRAMEC SLOAN PLUGS

- **Made in the USA!**
- Plugs Use Plated Brass Terminals for Excellent Corrosion Resistance
- High Strand Count Copper Conductors
- Meets SAE J560
- Finger Grips for a Positive Pull
- Zinc 7-Way & ISO Plugs Feature Our **Premium Spring Guard:** Tightly Wound with a Yellow Zinc Dichromate Finish for Extra Corrosion Protection. Plus, Integrated Loop for Easy Hang Up



7-WAY ZINC PLUGS

P/N	DESCRIPTION
421001	Zinc Plug with Spring Guard
421000	Zinc Plug without Spring Guard
421177	Zinc Plug with Spring Guard, Single Grip

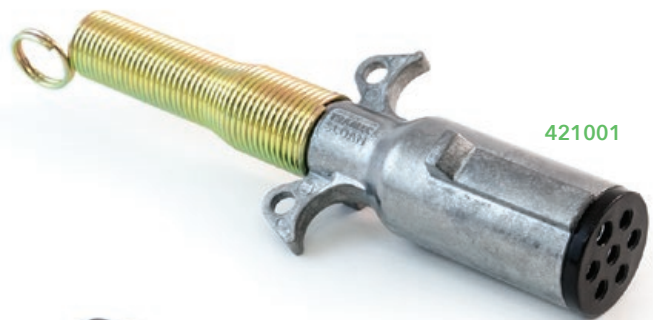

421001

7-WAY NYLON PLUG

Field Replaceable Plug

P/N	DESCRIPTION
421147	Glass Reinforced Nylon Plug with Spring
421148	Glass Reinforced Nylon Plug without Spring
421151	Nylon Plug Interior with Mounting Screw



421148

7-WAY PLUG SPRING GUARD

P/N	DESCRIPTION
3810012	Spring Guard



3810012

7-WAY ISO PLUG

P/N	DESCRIPTION
421162	Zinc ISO Plug with Spring Guard



421162

SINGLE & DUAL POLE PLUGS

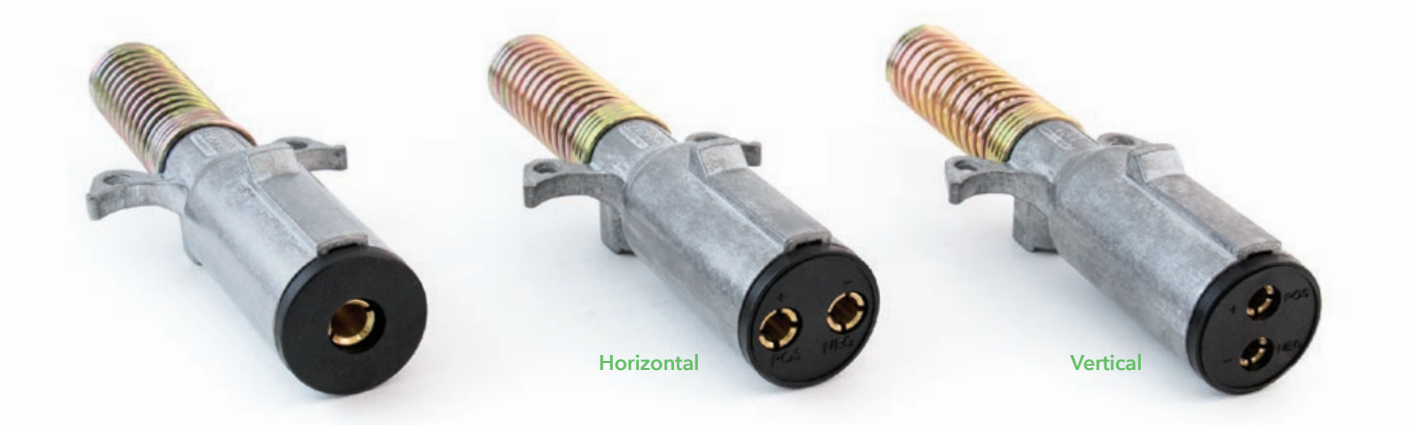

P/N	DESCRIPTION
421127	Single Pole Zinc Plug with Spring Guard and 2-1/2" Heat Shrink Tubing
421170	Horizontal Dual Pole Zinc Plug with Spring Guard
421324	Vertical Dual Pole Plug with Spring Guard - 4 GA
421325	Vertical Dual Pole Plug with Spring Guard - 6 GA

4 & 6-WAY PLUGS

P/N	DESCRIPTION
421175	4-Way Zinc Plug with Spring Guard
421174	4-Way Zinc Plug without Spring Guard
421122	6-Way Zinc Plug with Spring Guard
421135	6-Way Zinc Plug without Spring Guard



RV PLUGS

P/N	DESCRIPTION
421137	7-Way RV Plug-Blade Style
421133	5-Way Chrome Plated Plug without Spring
421131	4 Way Chrome Plated Plug without Spring



7-WAY PLUG & SOCKET BRUSH

- Double-Ended Brush
- Regularly Using a Plug Cleaner to Maintain Terminals Helps Ensure Good Contact for Trailer Electrical Connections

P/N	DESCRIPTION
422317	7-Way Plug & Socket Brush

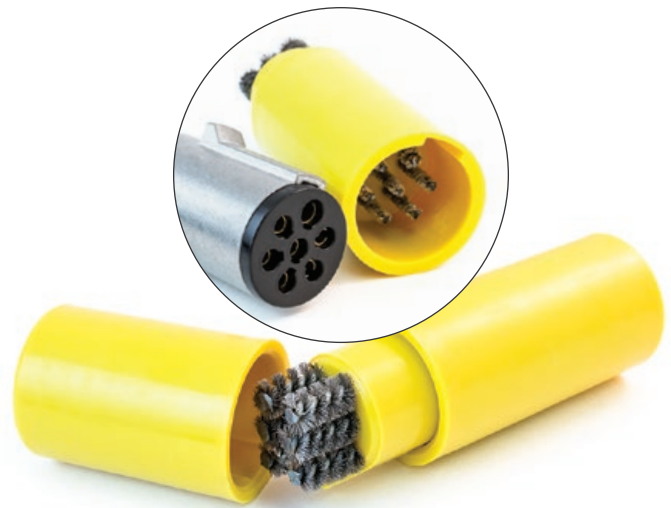

7-WAY CIRCUIT INSPECTOR

- Instantly Finds and Repairs Short or Faulty Circuits in the Shop or on the Road.
- Durable Nylon Body

P/N	DESCRIPTION
421758	7-Way Circuit Inspector



CONNECTOR ADAPTER

- Converts a 7-Way Blade to a 4-Way Molded Connector
- Allows a Vehicle to Tow Campers or Boats
- Connects Ground, L.T., R.T., and Stop Circuits
- Quick & Easy to Connect
- Full Length Plug Shell Ensures Positive Latching
- Non-Corrosive Nylon Shell & Insert
- Eliminate Makeshift Jumpers

P/N	DESCRIPTION
421139	Connector Adapter



MANUFACTURING SOCKETS & RECEPTACLES IN THE USA!

Tramec Sloan has been designing, manufacturing and assembling electric receptacles for over 25 years in our Iola, Kansas facility. From Single Pole to the revolutionary Smart Box® to glass reinforced Nylon or Zinc materials Tramec Sloan has the options, OEM quality and value you're looking for. It's no wonder that we're chosen by the leaders in both the OE Trailer & harness manufacturing Industries



**MANUFACTURING
IN THE U.S.A.**



**MEETS DOT & SAE
STANDARDS**



**CORROSION
RESISTANCE**



**HIGH QUALITY
COMPONENTS**

THE ORIGINAL SMART BOX[®]

You No Longer Have to Re-Wire the Nose Box when You Repair Receptacles the Smart Way!

- No Need to Disturb Wiring when Replacing the Receptacle! Wiring Remains Stationary On Studs Inside the Box
- Simply Plug in the Replacement Receptacle and Secure with Two Nuts
- Brass Jumpers Bridge from the Studs to the Receptacle Pins
- Stainless Steel Springs Around the Terminals Grip the Pins
- #10 Studs Provide Capacity for Multiple Terminals
- Fits Industry Standard Mounting Bolt Pattern
- Two Cable Entry Grommets



WITH THE SMART BOX[®] YOU CAN...

Forget the Old Tangled "Spaghetti Ball" of Wires that Cause Damage & Headaches

Say Goodbye to Loose Connections that Cause Shorts or Intermittent Open Circuits

Never Again Worry About Misrouted or Miswired Circuits

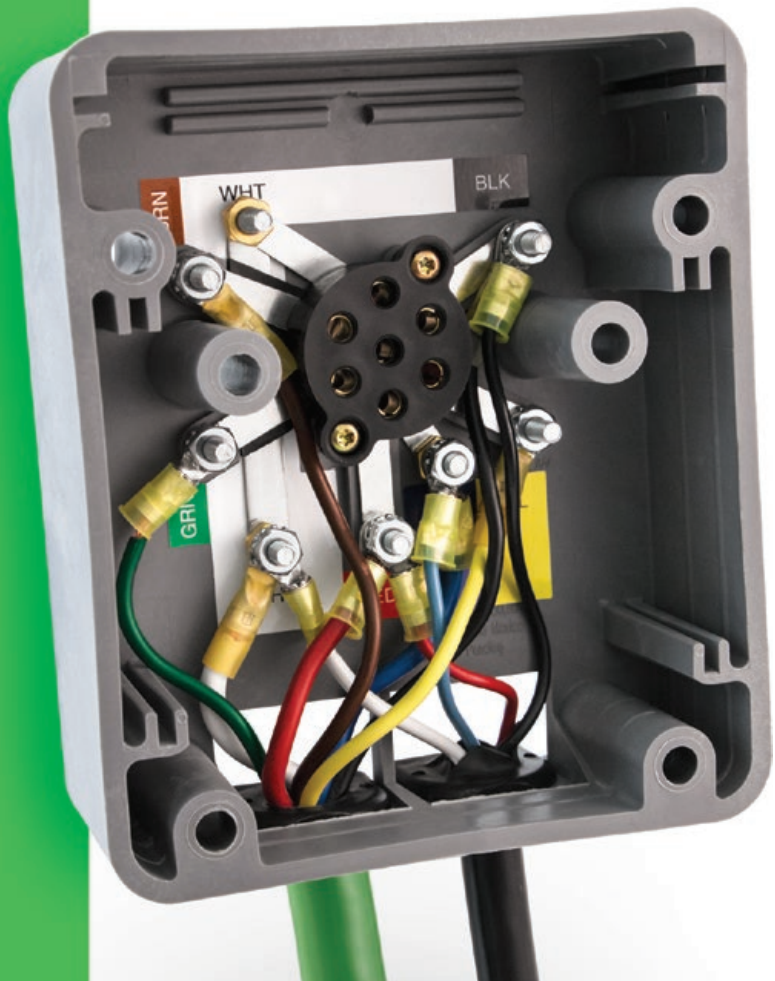



THE SMART BOX®

- The Fleet Friendly J560 Receptacle
- No Need to Disturb Wiring when Replacing the Receptacle!
- Wiring Remains Stationary on Studs Inside the Box. Simply Plug in the Receptacle and Secure with Two Nuts!

P/N	DESCRIPTION	MOUNTING	PINS
38520	Box & Nylon Receptacle	Surface Mount	Solid
38521	Box & Nylon Receptacle	Surface Mount	Split
38526	Box & Nylon Receptacle	Recessed Mount**	Solid
38527	Box & Nylon Receptacle	Recessed Mount**	Split
38523	Box & Zinc Receptacle	Surface Mount	Solid
38570	Box & Deep Nylon Receptacle*	Surface Mount	Solid
38571	Box & Deep Nylon Receptacle*	Surface Mount	Split
38720	ISO Style Box & Receptacle	Surface Mount	Solid

SMART BOX® ADAPTER BOXES

P/N	DESCRIPTION
3850031	Surface Mount Adapter Box
3850041	Recessed Mount Adapter Box**
3850008	Cover Gasket
3850015	Anodized Aluminum Cover Plate

*Deep Receptacles are 16% deeper than standard to allow max depth function for J560 plug & a more secure connection

SMART BOX® RECEPTACLES

P/N	DESCRIPTION	PINS
38501	Nylon Receptacle	Solid
38502	Nylon Receptacle	Split
38503	Zinc Receptacle	Solid
38505	Deep Nylon Receptacle*	Solid
38506	Deep Nylon Receptacle*	Split
38707	ISO Style Receptacle	Solid

BOX KITS

P/N	MOUNTING	INCLUDES
3850032	Surface Mount	Adapter Box, Gasket, Cover Plate, Two Grommets, Two Bolts, & Two Nuts
3850042	Recessed Mount**	Adapter Box, Gasket, Cover Plate, Two Grommets, Two Bolts, & Two Nuts

**Recessed Mount Boxes Hold Square-Neck Bolts from the Back for Mounting on Adapter Plates

THE DUAL SMART BOX®

- The **Dual Smart Box** Provides All the Advantages of the Classic Smart Box for Installations that Require Both the Primary & Auxiliary Sockets
- Mounts Using Industry Standard Nose Box Layout
- A Removable, Internal Jumper is Provided for Chassis Grounding

P/N	DESCRIPTION	PINS
38540	Dual Smart Box	Solid
38541	Dual Smart Box	Split

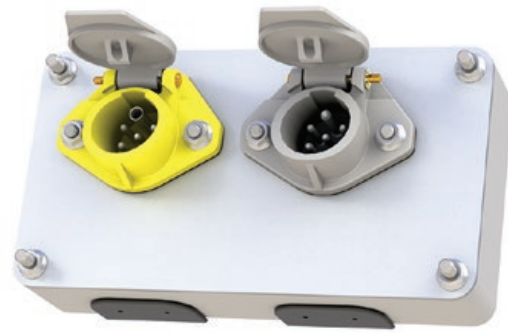

Exterior (Above) and Interior (Below) of the Dual Smart Box



THE JUMBO SMART BOX®

- The **Jumbo Smart Box** Provides All the Advantages of the Classic Smart Box with Double the Interior Space for Installation of Accessory Devices
- Mounts Using Industry Standard Nose Box Layout
- A Removable, Internal Jumper is Provided for Chassis Grounding

P/N	DESCRIPTION	PINS
38560	Jumbo Smart Box	Solid
38561	Jumbo Smart Box	Split

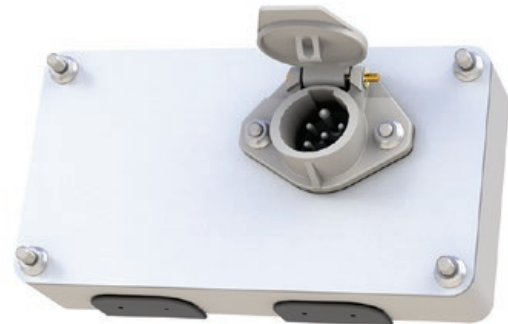

Exterior of Both Jumbo and Breaker Smart Boxes



Jumbo Smart Box Interior

THE BREAKER SMART BOX®

- The **Breaker Smart Box** Provides All the Advantages of the Classic Smart Box for Installations that Require Circuit Breakers
- Mounts Using Industry Standard Nose Box Layout
- A Removable, Internal Jumper is Provided for Chassis Grounding

P/N	DESCRIPTION	PINS
38550-15	Smart Box with 15A Breakers	Solid
38551-15	Smart Box with 15A Breakers	Split
38550-20	Smart Box with 20A Breakers	Solid
38551-20	Smart Box with 20A Breakers	Split
38550-30	Smart Box with 30A Breakers	Solid
38551-30	Smart Box with 30A Breakers	Split



Breaker Smart Box Interior

SMART BOX® ACCESSORIES

Extension Bolt Kit Includes Adapters & Bolts (4 Each) to Allow for Retrofit of Smart Box onto Existing Short 5/16"-18 Trailer Nose Box Bolts



P/N	DESCRIPTION
3850029	Extension Bolt Kit
3826020	Flange Nut for Receptacle
3826021	Bolt for Receptacle
38510*	Receptacle Lid Kit

*For Deep Style Receptacles Only

DUMMY NYLON RECEPTACLE

- Nylon Receptacle without Pins or Terminals
- Protects the Plug & Cable When not Connected to a Trailer
- Dummy Receptacle is 16% Deeper than Standard for Better Docking Ability

P/N	DESCRIPTION
38509	Dummy Receptacle



EASY SMART BOX® INSTALLATION

Install Any Style Smart Box Using these Simple Instructions



1. The box mounts on four 5/16" bolts using the industry standard nose box layout (mounting plate and bolts not included). Mount the Smart Box using four 5/16" flange nuts or nuts & washers (not included) inside the box.
2. Wiring can now be completed inside the box, without the need to install wiring directly to the back of the socket. No more spaghetti ball to force into the box!
3. After installing all wiring in the box, assemble the included gasket and anodized aluminum cover plate onto the molded-in bolts, using the included stainless steel flange nuts.
4. Apply a non-conductive (dielectric) grease, per TMC recommended practice RP-155, to receiver sockets & to the rear pins of the receptacle. This can reduce installation force, and increase life of the connector.

Fully engage rear pins of the receptacle with the receiver in the box using only *hand force* to ensure alignment before installing the provided stainless steel flange nuts. **Do not** use nuts to draw the receptacle pins into the receiver. Misalignment may damage the assembly, and cause poor connections.

30-PIN, 7-WAY RECEPTACLE

- One Stud of Each Circuit Group Has a Larger Hex (5/16"). This Stud May be Removed and Reinstalled Through #10 Ring Terminals when More than Four Leads are Needed
- Receptacles Have One #10 Terminal and Six Ø.180 Push-Ons at White (Ground)
- Each Circuit; Brown, Green, Red, Yellow, Black, and Blue, Can Support Up to Four Ø.180 Push-On Connections with One #10 Terminal
- Kits Include Gasket, Grommet, and Receptacle Mounting Screws, but Do Not Include Box Mounting Hardware.
- Boxes Have Standard Mounting Dimensions



30-PIN, 7-WAY RECEPTACLE - NYLON

- Made of Non-Corrosive, Reinforced Nylon
- SAE J560 Nylon Style Receptacles & Box
- For Chassis Ground Option, Add Suffix "G"
- 4-Inch Deep Adapter Box

P/N	DESCRIPTION	PINS
38304	30-Pin Nylon Receptacle	Solid
38305	30-Pin Nylon Receptacle	Split
38306	30-Pin Nylon Receptacle & Box	Solid
38307	30-Pin Nylon Receptacle & Box	Split



30-PIN, 7-WAY RECEPTACLE - ZINC

- SAE J560 Zinc Style Receptacles & Box
- 3-Inch Deep Adapter Box

P/N	DESCRIPTION	PINS
38844	30-Pin Zinc Receptacle	Solid
38845	30-Pin Zinc Receptacle	Split
38848	30-Pin Zinc Receptacle & Box	Solid
38849	30-Pin Zinc Receptacle & Box	Split



NYLON 7-WAY RECEPTACLES

- An OEM Favorite!
- SAE J560 Style Receptacles
- 43% Glass Fiber Reinforced Impact Modified Nylon
- Includes Neoprene Mounting Gaskets
- Hinge Retainer Pin Used to Enhance the Serviceability of the Lid
- Tramec Sloan Nylon Receptacles Feature a Direct Wired Ground for the Safest Possible Connections
- Tramec Sloan Recommends Ring Terminals for the Connection Between Wires and Receptacle Pins for Positive Mechanical Connections

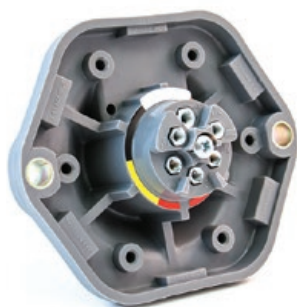

Screw Terminals



Circuit Breakers



Stacking Studs
(Junction Box Use)

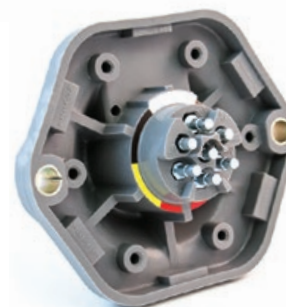

Push-On Terminals

P/N	DESCRIPTION	PINS
38200	Nylon Large Flange with Screw Terminals	Solid Pin
38202	Nylon Large Flange with Screw Terminals	Split Pin
38210	Nylon Receptacle with 15A Circuit Breakers	Solid Pin
38211	Nylon Receptacle with 15A Circuit Breakers	Split Pin
38212	Nylon Receptacle with 20A Circuit Breakers	Solid Pin
38213	Nylon Receptacle with 20A Circuit Breakers	Split Pin
38214	Nylon Receptacle with 30A Circuit Breakers	Solid Pin
38215	Nylon Receptacle with 30A Circuit Breakers	Split Pin
38216	Nylon Receptacle with 40A Circuit Breakers	Solid Pin
38217	Nylon Receptacle with 40A Circuit Breakers	Split Pin
38360	Nylon Receptacle with Stacking Studs	Solid Pin
38361	Nylon Receptacle with Stacking Studs	Split Pin
38310	Nylon Receptacle with Push-On Terminals	Solid Pin
38312	Nylon Receptacle with Push-On Terminals	Split Pin
38730	ISO Style Nylon Receptacle with #10 Studs	Solid Pin
38731	ISO Style Nylon Receptacle with #10 Studs	Split Pin
38730-15	ISO Style Nylon Receptacle with 15A Circuit Breakers	Solid Pin
38731-15	ISO Style Nylon Receptacle with 15A Circuit Breakers	Split Pin
38730-20	ISO Style Nylon Receptacle with 20A Circuit Breakers	Solid Pin
38731-20	ISO Style Nylon Receptacle with 20A Circuit Breakers	Split Pin
38730-30	ISO Style Nylon Receptacle with 30A Circuit Breakers	Solid Pin
38731-30	ISO Style Nylon Receptacle with 30A Circuit Breakers	Split Pin

NYLON 7-WAY RECEPTACLES WITH ADAPTER BOXES

- SAE J560 Nylon Style Receptacles & Box
- 43% Glass Fiber Reinforced Impact Modified Nylon
- For Chassis Ground Option, Add Suffix "G"
- **2" and 3" Boxes:** Back Side is Closed Against Mounting Surface. For Harness Entry from Back, add suffix "B"



Back Entry

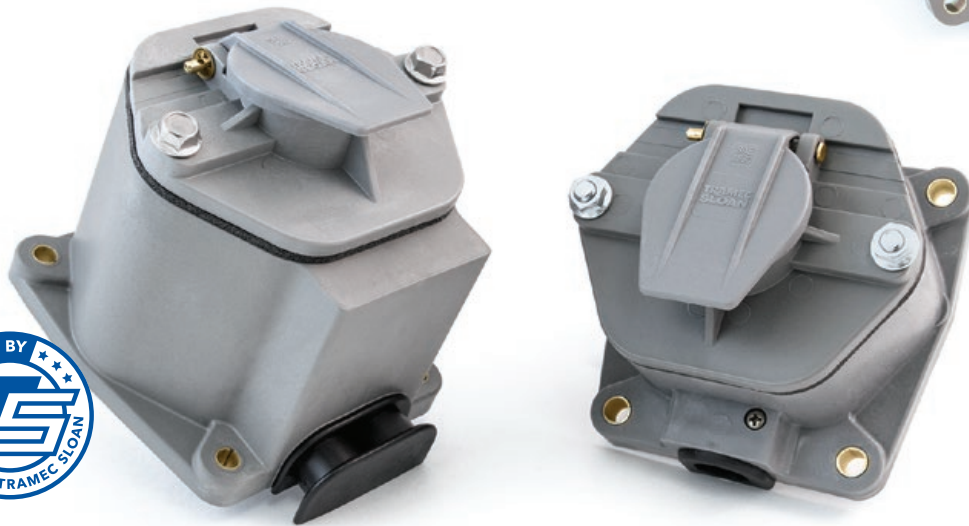

P/N	BOX DEPTH	DESCRIPTION	PINS
38350	2"	Nylon Receptacle with Stacking Studs and Adapter Box	Solid Pin
38351	2"	Nylon Receptacle with Stacking Studs and Adapter Box	Split Pin
38340	2"	Nylon Receptacle with 15A Circuit Breakers and Adapter Box	Solid Pin
38341	2"	Nylon Receptacle with 15A Circuit Breakers and Adapter Box	Split Pin
38342	2"	Nylon Receptacle with 20A Circuit Breakers and Adapter Box	Solid Pin
38343	2"	Nylon Receptacle with 20A Circuit Breakers and Adapter Box	Split Pin
38344	2"	Nylon Receptacle with 30A Circuit Breakers and Adapter Box	Solid Pin
38345	2"	Nylon Receptacle with 30A Circuit Breakers and Adapter Box	Split Pin
38450	3"	Nylon Receptacle with Stacking Studs and Adapter Box	Solid Pin
38451	3"	Nylon Receptacle with Stacking Studs and Adapter Box	Split Pin
38440	3"	Nylon Receptacle with 15A Circuit Breakers and Adapter Box	Solid Pin
38441	3"	Nylon Receptacle with 15A Circuit Breakers and Adapter Box	Split Pin
38442	3"	Nylon Receptacle with 20A Circuit Breakers and Adapter Box	Solid Pin
38443	3"	Nylon Receptacle with 20A Circuit Breakers and Adapter Box	Split Pin
38444	3"	Nylon Receptacle with 30A Circuit Breakers and Adapter Box	Solid Pin
38445	3"	Nylon Receptacle with 30A Circuit Breakers and Adapter Box	Split Pin
38452	4"	Nylon Receptacle with Stacking Studs and Adapter Box	Solid Pin
38453	4"	Nylon Receptacle with Stacking Studs and Adapter Box	Split Pin
38460	4"	Nylon Receptacle with 15A Circuit Breakers and Adapter Box	Solid Pin
38461	4"	Nylon Receptacle with 15A Circuit Breakers and Adapter Box	Split Pin
38462	4"	Nylon Receptacle with 20A Circuit Breakers and Adapter Box	Solid Pin
38463	4"	Nylon Receptacle with 20A Circuit Breakers and Adapter Box	Split Pin
38464	4"	Nylon Receptacle with 30A Circuit Breakers and Adapter Box	Solid Pin
38465	4"	Nylon Receptacle with 30A Circuit Breakers and Adapter Box	Split Pin

SURFACE MOUNT NYLON ADAPTER BOXES

- Made of 43% Glass Fiber Reinforced Impact Modified Nylon
- Back Entry Boxes Include Gasket
- For Chassis Ground Option, Add Suffix "G"

P/N	DESCRIPTION	ENTRY
38260	1" Inside Depth	Bottom
38260B	1" Inside Depth	Back
38265	2" Inside Depth	Bottom
38265B	2" Inside Depth	Back
3826035	3" Inside Depth	Bottom
3826035B	3" Inside Depth	Back
3826040	4" Inside Depth	Solid Pin
3826022-1	Adapter for Small 2-Hole Receptacles	-
3826047	Stainless Steel Cover Plate	-



SMALL STYLE TWO-HOLE MOUNTING NYLON RECEPTACLES

- SAE J560 Nylon Style Receptacles
- Made of 43% Glass Fiber Reinforced Impact Modified Nylon

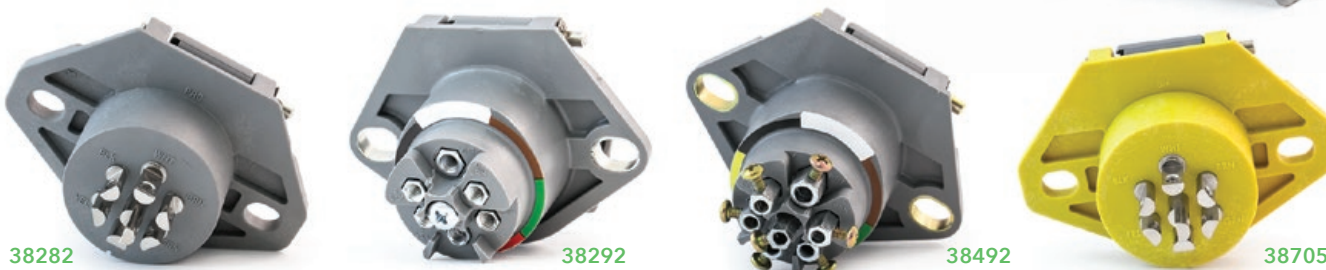

P/N	DESCRIPTION	PINS	GASKET
38282	180° Connection Screw Terminals	Solid Pin	3850200
38283	180° Connection Screw Terminals	Split Pin	3850200
38290	90° Connection Screw Terminals	Solid Pin	3829002
38292	90° Connection Screw Terminals	Split Pin	3829002
38296	Push-On Terminals	Solid Pin	3829002
38298	Push-On Terminals	Split Pin	3829002
421149	Wire Insert Terminals	Solid Pin	3829002
38492	Wire Insert Terminals	Split Pin	3829002
38394	180° Connection Screw Terminals with Boot	Solid Pin	-
38395	180° Connection Screw Terminals with Boot	Split Pin	-
38396	Push-On Terminals with Boot	Solid Pin	-
38397	Push-On Terminals with Boot	Split Pin	-
38705	Yellow ISO Style, 180° Connection Screw Terminals	Solid Pin	3850200
38706	Yellow ISO Style, 180° Connection Screw Terminals	Split Pin	3850200

NYLON HORIZONTAL DUAL POLE RECEPTACLE

- Receptacle & Box Made of 43% Glass Fiber Reinforced Impact Modified Nylon
- Stainless Steel Cover Plate

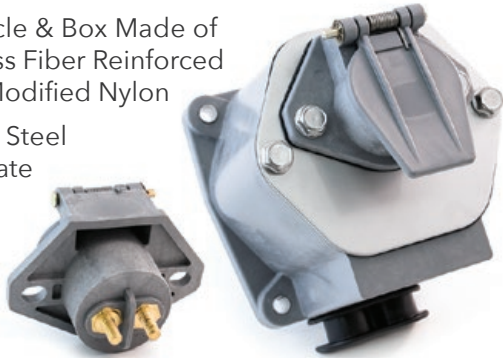

P/N	DESCRIPTION
38424	Nylon 2-Pole Receptacle with 4" Box
38493	Nylon 2-Pole Receptacle

NYLON 4-WAY RECEPTACLE

- Made of Non-Corrosive, Reinforced Nylon
- Mates with Standard Round 4-Way Plug
- Split Pins with Wire Insert Terminals
- Mounting is the Same as Metal Versions
- Stainless Steel Hinge Pin and Spring



P/N	DESCRIPTION
38714	Nylon 4-Way Receptacle

OVER-MOLDED RECEPTACLES

- **Made in the USA!**
- An OEM Favorite
- SAE J560 Primary & ISO 3731 Auxiliary Style Nylon Receptacles
- Made of Non-Corrosive, Reinforced Nylon
- Supplied with 48" Blunt-Cut ABS Cable
- Pins are Insert-Molded to Seal Out Moisture & Contaminants
- Brass Pins are Plated for Long Life

- Wire-to-Pin Terminations are Sealed in an Over-Molded "Boot"
- Custom Lengths & Termination Options Available. Contact Your Tramec Sloan Rep for More Info
- Over-Mold is Bonded to Receptacle & Cable Jacket
- ABS Style (SAE J2394) Heavy Gage Cable (1/8 - 2/10 - 4/12 ga)
- Gaskets (3850200) are Pre-Applied to the Mounting Flange



38408-04



38410-04

P/N	DESCRIPTION	PINS
38402-04	Straight Style Primary J560	Solid Pin
38403-04	Straight Style Primary J560	Split Pin
38407-04	90° Style (6 o'Clock) Primary J560	Solid Pin
38408-04	90° Style (6 o'Clock) Primary J560	Split Pin
38410-04	Straight Style Auxiliary (ISO)	Solid Pin
38412-04	90° Style (6 o'Clock) Auxiliary (ISO)	Split Pin

ZINC 7-WAY RECEPTACLES

- **Manufacturing in the USA!**
- An OEM Favorite!
- SAE J560 Style Receptacles
- Bodies are Made of Die-Cast Zinc with Stainless Steel Hinge Pin & Spring
- Includes Neoprene Mounting Gaskets
- Receptacle Inserts are O-Ring Sealed and Self-Grounding
- Tramec Sloan Recommends Ring Terminals for the Connection Between Wires and Receptacle Pins for Positive Mechanical Connections



P/N	DESCRIPTION	PINS
38800	Zinc Receptacle without Circuit Breakers	Solid Pin
38801	Zinc Receptacle without Circuit Breakers	Split Pin
38810	Zinc Receptacle with 15A Circuit Breakers	Solid Pin
38811	Zinc Receptacle with 15A Circuit Breakers	Split Pin
38812	Zinc Receptacle with 20A Circuit Breakers	Solid Pin
38813	Zinc Receptacle with 20A Circuit Breakers	Split Pin
38814	Zinc Receptacle with 30A Circuit Breakers	Solid Pin
38815	Zinc Receptacle with 30A Circuit Breakers	Split Pin

SURFACE MOUNT ZINC ADAPTER BOXES

- Bodies are Made of Die-Cast Zinc
- Adapter Boxes Fit Industry Standard Hole Pattern
- 3" Deep Box Features a Double Grommet
- Adapter Boxes Include Gasket, Grommet, and Receptacle Mounting Screws

P/N	DESCRIPTION
38860	2" Deep Die-Cast Zinc Adapter Box
38861	3" Deep Die-Cast Zinc Adapter Box



ZINC RECEPTACLE & ADAPTER BOX KITS

- Manufacturing in the USA!
- An OEM Favorite!
- SAE J560 Style Receptacles & Adapter Boxes
- Receptacles & Adapter Boxes are Made of Die-Cast Zinc
- Kits Include Gasket, Grommet, and Receptacle Mounting Screws
- Kits Do Not Include Box Mounting Hardware

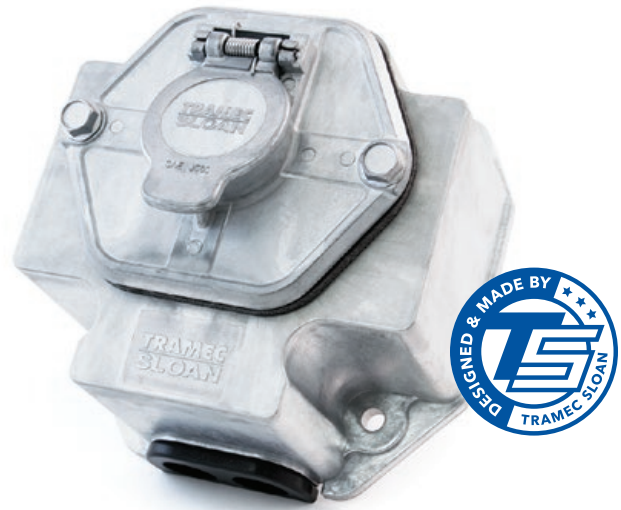

P/N	BOX DEPTH	DESCRIPTION	PINS
38802	2"	Zinc Receptacle and Adapter Box without Circuit Breakers	Solid Pin
38803	2"	Zinc Receptacle and Adapter Box without Circuit Breakers	Split Pin
38820	2"	Zinc Receptacle and Adapter Box with 15A Circuit Breakers	Solid Pin
38821	2"	Zinc Receptacle and Adapter Box with 15A Circuit Breakers	Split Pin
38822	2"	Zinc Receptacle and Adapter Box with 20A Circuit Breakers	Solid Pin
38823	2"	Zinc Receptacle and Adapter Box with 20A Circuit Breakers	Split Pin
38824	2"	Zinc Receptacle and Adapter Box with 30A Circuit Breakers	Solid Pin
38825	2"	Zinc Receptacle and Adapter Box with 30A Circuit Breakers	Split Pin
38804	3"	Zinc Receptacle and Adapter Box without Circuit Breakers	Solid Pin
38805	3"	Zinc Receptacle and Adapter Box without Circuit Breakers	Split Pin
38830	3"	Zinc Receptacle and Adapter Box with 15A Circuit Breakers	Solid Pin
38831	3"	Zinc Receptacle and Adapter Box with 15A Circuit Breakers	Split Pin
38832	3"	Zinc Receptacle and Adapter Box with 20A Circuit Breakers	Solid Pin
38833	3"	Zinc Receptacle and Adapter Box with 20A Circuit Breakers	Split Pin
38834	3"	Zinc Receptacle and Adapter Box with 30A Circuit Breakers	Solid Pin
38835	3"	Zinc Receptacle and Adapter Box with 30A Circuit Breakers	Split Pin

ZINC SINGLE & DUAL POLE RECEPTACLES

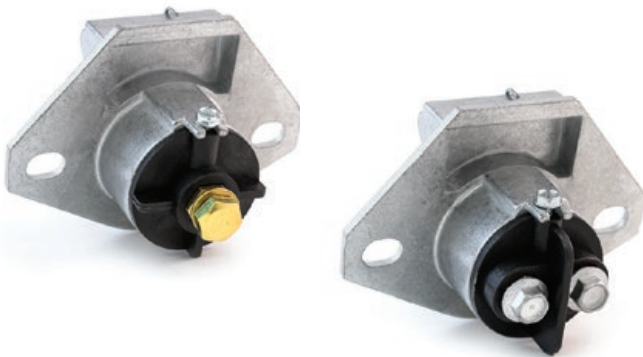

P/N	RECEPTACLE
421126	Zinc Single Pole Receptacle
421171	Horizontal Zinc Dual Pole Receptacle
421326	Vertical Zinc Dual Pole Receptacle

ZINC SINGLE & HORIZONTAL DUAL POLE RECEPTACLES WITH ADAPTER BOXES

- Stainless Steel Cover Plate
- Made in the USA



P/N	RECEPTACLE	ADAPTER BOX
38421	Zinc Single Pole	4" Nylon Box
38422	Zinc Dual Pole	4" Nylon Box
38423	Zinc Dual Pole	3" Zinc Adapter Box

ZINC 7-WAY SOCKETS

- Brass Contact Pin Screws; Won't Cut Copper Wires
- Built-In Receptacle "Ledge" for Plug and Cable Support: Relieves Strain on Contact Pins and Plug Bushings. Also Reduces Chance of Flickering From Plug Drop-Out on Trailers
- Splash-Proof Lid Design: Overlap Design Prevents Water Spray with No Need for Gaskets
- Indexed & Lock Pin with "Floating" Design for Easy Plug Engagement Prevents Contact Pin Bending
- Partitioned Insert Design Reduces Chances of Wire Shorts
- Each Terminal Clearly Marked to Insure Correct Circuit Wiring
- Heavy Duty Insert Anchor Screws



421015



421119

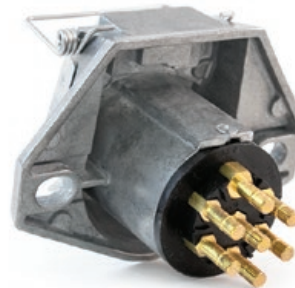

421121



421124

P/N	PINS	TERMINALS
421015	Split Pin	Wire Insert
421119	Solid Pin	Ring
421121	Solid Pin	Bullet Style for Push-On AMP Style Terminals
421124	Solid Pin	Wire Insert

4 & 5-WAY SOCKETS



P/N	DESCRIPTION
421132	Chrome Plated, Split-Pin 4-Way Socket
421134	Chrome Plated, Split-Pin 5-Way Socket
421176	Zinc Split-Pin, 4-Way Socket, Rear Entry

ZINC 6-WAY SOCKETS



P/N	DESCRIPTION
421123	Zinc 6-Way Socket, Exposed Terminals
421136	Zinc 6-Way Socket, Concealed Terminals

7-WAY RV SOCKET

- Thermoplastic Material
- Blade Type Pin

P/N	DESCRIPTION
421138	7-Way RV Socket (Car End)



RECEPTACLE BOOTS



P/N	DESCRIPTION
3827005	Receptacle Boot - End Access
3820017	Large Flange Receptacle Boot - Bottom Access
3849709	Boot for Die Cast 7-Way Receptacle

ADAPTER BOX GROMMETS



P/N	DESCRIPTION
3826004	Single Grommet
3826045	Double Grommet

LID KIT FOR NYLON RECEPTACLES

- Easy-to-Install 5-Piece Lid Kit for Field Repairs
- Kit Includes: Gray Nylon Lid, Steel Hinge Pin, Stainless Steel Spring, Shaft Retainer & Cotter Pin



P/N	DESCRIPTION
38204	Gray Nylon Receptacle Lid Kit

LOOKING FOR CIRCUIT BREAKERS? Many Styles Available on Pages 268 & 269

RECEPTACLE GASKETS



P/N	DESCRIPTION	USE WITH
3820009	Self-Adhesive Receptacle Gasket	Large Flange Nylon Receptacles & Cover Plate 3826047
3829002	Self-Adhesive Receptacle Gasket	Small Nylon Receptacles (3829X Series)
3850200	Self-Adhesive Receptacle Gasket	Small Nylon Receptacles (3828X, 384XX, 385XX & 387XX)
3870102	Self-Adhesive Receptacle Gasket	Small Zinc Receptacles (Single & Dual Pole and 7-Way)

JUNCTION BOXES

- Constructed of High-Impact Plastic for Added Durability & Long-Lasting Life
- Includes Grommets, Lid Screws, and Stud Nuts



P/N	DESCRIPTION	PORTS	MOUNTING HOLES
421128	Junction Box with 7 Stud Wire Connections	5	8.12" x 3.19"
421246	Compact Junction Box with 7 Stud Wire Connections	5	7.38"
422327	Junction Box with Five 20 AMP Circuit Breakers, Insert & Bracket	6	8.12" x 3.25"
422328	Junction Box with 10 Stud Wire Connections	6	8.12" x 3.19"
422329	Sealed Junction Box with 20 Stud Wire Connections	7	8.5625" x 5.0625"
422634	Junction Box with 7 Stud Wire Connections	4	8" x 3.19"
422635	Junction Box with Circuit Breaker Bracket (Breakers Not Included)	6	8" x 3.19"

421128



422329



421246



422634



422327

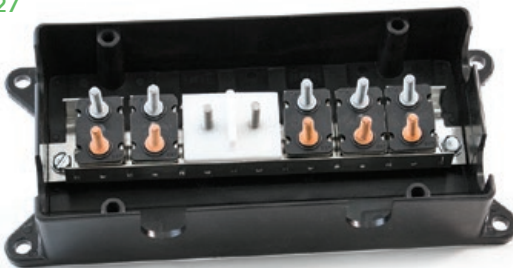

422635



422328



BATTERY & STARTER CABLE

- Constructed with Soft Annealed, Flexible Stranded Copper
- Insulated with High Quality Thermoplastic
- Meets SAE J1127 Type SGT



P/N	DESCRIPTION	AWG SIZE	STRANDING	NOM. O.D.	JACKET	LENGTH
422241	Battery Cable	6	49	.308"	Red	25 ft.
422242	Battery Cable	6	49	.308"	Red	100 ft.
422243	Battery Cable	6	49	.308"	Black	25 ft.
422244	Battery Cable	6	49	.308"	Black	100 ft.
422245	Battery Cable	4	133	.350"	Red	25 ft.
422246	Battery Cable	4	133	.350"	Red	100 ft.
422247	Battery Cable	4	133	.350"	Black	25 ft.
422248	Battery Cable	4	133	.350"	Black	100 ft.
422249	Battery Cable	2	133	.455"	Red	25 ft.
422250	Battery Cable	2	133	.455"	Red	100 ft.
422251	Battery Cable	2	133	.455"	Black	25 ft.
422252	Battery Cable	2	133	.455"	Black	100 ft.
422253	Battery Cable	1	133	.490"	Red	25 ft.
422254	Battery Cable	1	133	.490"	Red	100 ft.
422255	Battery Cable	1	133	.490"	Black	25 ft.
422256	Battery Cable	1	133	.490"	Black	100 ft.
422257	Starter Cable	1/0	133	.535"	Red	25 ft.
422258	Starter Cable	1/0	133	.535"	Red	100 ft.
422259	Starter Cable	1/0	133	.535"	Black	25 ft.
422260	Starter Cable	1/0	133	.535"	Black	100 ft.
422261	Starter Cable	2/0	133	.585"	Red	25 ft.
422262	Starter Cable	2/0	133	.585"	Red	100 ft.
422263	Starter Cable	2/0	133	.585"	Red	250 ft.
422264	Starter Cable	2/0	133	.585"	Black	25 ft.
422265	Starter Cable	2/0	133	.585"	Black	100 ft.
422266	Starter Cable	2/0	133	.585"	Black	250 ft.
422267	Starter Cable	3/0	259	.675"	Black	25 ft.
422268	Starter Cable	3/0	259	.675"	Black	100 ft.
422269	Starter Cable	4/0	259	.740"	Black	25 ft.
422270	Starter Cable	4/0	259	.740"	Black	100 ft.

PRIMARY WIRE

- GPT-Type Primary Wire is the Most Widely Used General Purpose Wire Used by OEMs & Re-Wiring Accessory Installers
- Constructed with Soft Annealed, Flexible Stranded Copper
- Insulated with High Quality Thermoplastic
- Meets SAE J1128 Type GPT

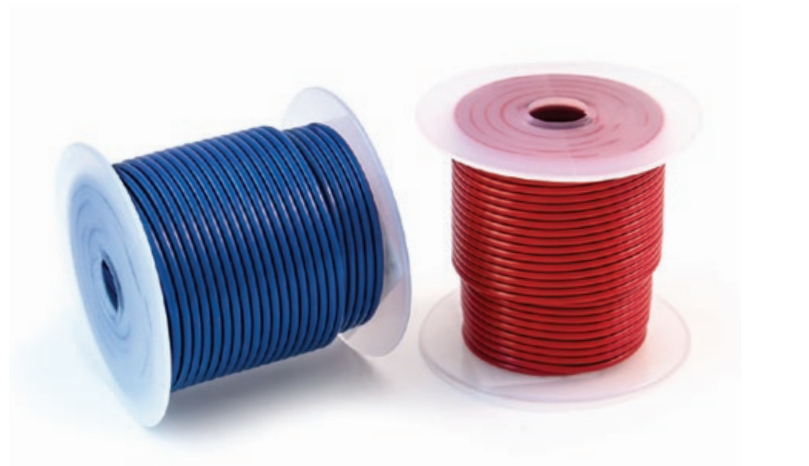

P/N	DESCRIPTION	AWG SIZE	STRANDING	NOM. O.D.	JACKET	LENGTH
422273	Primary Wire	18	16	.095"	Black	100 ft.
422274	Primary Wire	18	16	.095"	Blue	100 ft.
422275	Primary Wire	18	16	.095"	Brown	100 ft.
422276	Primary Wire	18	16	.095"	Green	100 ft.
422277	Primary Wire	18	16	.095"	Red	100 ft.
422278	Primary Wire	18	16	.095"	White	100 ft.
422279	Primary Wire	18	16	.095"	Yellow	100 ft.
422280	Primary Wire	16	19	.106"	Black	100 ft.
422280-1000	Primary Wire	16	19	.106"	Black	1000 ft.
422281	Primary Wire	16	19	.106"	Blue	100 ft.
422281-1000	Primary Wire	16	19	.106"	Blue	1000 ft.
422282	Primary Wire	16	19	.106"	Brown	100 ft.
422282-1000	Primary Wire	16	19	.106"	Brown	1000 ft.
422283	Primary Wire	16	19	.106"	Green	100 ft.
422283-1000	Primary Wire	16	19	.106"	Green	1000 ft.
422284	Primary Wire	16	19	.106"	Red	100 ft.
422284-1000	Primary Wire	16	19	.106"	Red	1000 ft.
422285	Primary Wire	16	19	.106"	White	100 ft.
422285-1000	Primary Wire	16	19	.106"	White	1000 ft.
422286	Primary Wire	16	19	.106"	Yellow	100 ft.
422286-1000	Primary Wire	16	19	.106"	Yellow	1000 ft.
422287	Primary Wire	14	19	.118"	Black	100 ft.
422287-1000	Primary Wire	14	19	.118"	Black	1000 ft.
422288	Primary Wire	14	19	.118"	Blue	100 ft.
422288-1000	Primary Wire	14	19	.118"	Blue	1000 ft.
422289	Primary Wire	14	19	.118"	Brown	100 ft.
422289-1000	Primary Wire	14	19	.118"	Brown	1000 ft.
422290	Primary Wire	14	19	.118"	Green	100 ft.
422290-1000	Primary Wire	14	19	.118"	Green	1000 ft.
422291	Primary Wire	14	19	.118"	Red	100 ft.
422291-1000	Primary Wire	14	19	.118"	Red	1000 ft.
422292	Primary Wire	14	19	.118"	White	100 ft.
422292-1000	Primary Wire	14	19	.118"	White	1000 ft.
422293	Primary Wire	14	19	.118"	Yellow	100 ft.
422293-1000	Primary Wire	14	19	.118"	Yellow	1000 ft.

PRIMARY WIRE *CONTINUED*

P/N	DESCRIPTION	AWG SIZE	STRANDING	NOM. O.D.	JACKET	LENGTH
422294	Primary Wire	12	19	.143"	Black	100 ft.
422294-1000	Primary Wire	12	19	.143"	Black	1000 ft.
422295	Primary Wire	12	19	.143"	Blue	100 ft.
422295-1000	Primary Wire	12	19	.143"	Blue	1000 ft.
422296	Primary Wire	12	19	.143"	Brown	100 ft.
422296-1000	Primary Wire	12	19	.143"	Brown	1000 ft.
422297	Primary Wire	12	19	.143"	Green	100 ft.
422297-1000	Primary Wire	12	19	.143"	Green	1000 ft.
422298	Primary Wire	12	19	.143"	Red	100 ft.
422298-1000	Primary Wire	12	19	.143"	Red	1000 ft.
422299	Primary Wire	12	19	.143"	White	100 ft.
422299-1000	Primary Wire	12	19	.143"	White	1000 ft.
422300	Primary Wire	12	19	.143"	Yellow	100 ft.
422300-1000	Primary Wire	12	19	.143"	Yellow	1000 ft.
422301	Primary Wire	10	19	.174"	Black	100 ft.
422302	Primary Wire	10	19	.174"	Blue	100 ft.
422303	Primary Wire	10	19	.174"	Brown	100 ft.
422304	Primary Wire	10	19	.174"	Green	100 ft.
422305	Primary Wire	10	19	.174"	Red	100 ft.
422306	Primary Wire	10	19	.174"	White	100 ft.
422307	Primary Wire	10	19	.174"	Yellow	100 ft.
422308	Primary Wire	8	37	.205"	Black	100 ft.
422309	Primary Wire	8	37	.205"	Red	100 ft.
422492	Primary Wire	8	37	.205"	Blue	100 ft.
422493	Primary Wire	8	37	.205"	White	100 ft.

WELDING CABLE

P/N	DESCRIPTION	GAUGE	O.D.	COLOR	LENGTH
422499	Welding Cable	1/0	.580"	Black	25 ft.
422500	Welding Cable	2/0	.615"	Black	25 ft.
422501	Welding Cable	4	.380"	Black	25 ft.

EXTENSION CABLE

P/N	DESCRIPTION	GAUGE	O.D.	COLORS	LENGTH
422502	Extension Cable	3/16	.325"	BK W GN	250 ft.

LIFTGATE CHARGING CABLE

P/N	DESCRIPTION	GAUGE	O.D.	COLOR	LENGTH
422503	Charging Cable	2/4	.38"x.80"	Black	100 ft.

TRAILER CABLE - BLACK JACKET

- Jacket is Temperature Rated at -70°F to +185°F
- Resistant to Gasoline, Water Solvents, Abrasion, Cutting, Ozone, and Sunlight
- Exceeds SAE Standards



P/N	CONDUCT.	AWG SIZE	STRANDING	O.D	COLORS						LENGTH	
422215	4	14	19	Ø.350	-	-	BN	G	-	W	Y	50 ft.
422216	4	14	19	Ø.350	-	-	BN	G	-	W	Y	100 ft.
422217	4	14	19	Ø.350	-	-	BN	G	-	W	Y	250 ft.
422218	4	14	19	Ø.350	-	-	BN	G	-	W	Y	500 ft.
422219	4	14	19	Ø.350	-	-	BN	G	-	W	Y	1000 ft.
422220	6	14	19	Ø.515	BK	-	BN	G	R	W	Y	50 ft.
422221	6	14	19	Ø.515	BK	-	BN	G	R	W	Y	100 ft.
422222	6	14	19	Ø.515	BK	-	BN	G	R	W	Y	250 ft.
422223	6	14	19	Ø.515	BK	-	BN	G	R	W	Y	500 ft.
422224	7	14	19	Ø.515	BK	-	BN	G	R	W	Y	1000 ft.
422471	6	14	19	Ø.450	BK	BL	BN	G	R	W	Y	100 ft.
422225	6	14	19	.525	BK	BL	BN	G	R	-	Y	50 ft.
	1	12			-	-	-	-	-	W	-	
422226	6	14	19	.525	BK	BL	BN	G	R	-	Y	100 ft.
	1	12			-	-	-	-	-	W	-	
422227	6	14	19	.525	BK	BL	BN	G	R	-	Y	250 ft.
	1	12			-	-	-	-	-	W	-	
422228	6	14	19	.525	BK	BL	BN	G	R	-	Y	500 ft.
	1	12			-	-	-	-	-	W	-	
422229	6	14	19	.525	BK	BL	BN	G	R	-	Y	1000 ft.
	1	12			-	-	-	-	-	W	-	
422230	6	12	19	Ø.600	BK	BL	BN	G	R	-	Y	50 ft.
	1	10			-	-	-	-	-	W	-	
422231	6	12	19	Ø.600	BK	BL	BN	G	R	-	Y	100 ft.
	1	10			-	-	-	-	-	W	-	
422232	6	12	19	Ø.600	BK	BL	BN	G	R	-	Y	250 ft.
	1	10			-	-	-	-	-	W	-	
422233	6	12	19	Ø.600	BK	BL	BN	G	R	-	Y	500 ft.
	1	10			-	-	-	-	-	W	-	
422234	6	12	19	Ø.600	BK	BL	BN	G	R	-	Y	1000 ft.
	1	10			-	-	-	-	-	W	-	
422477	2	14	-	-	BK	-	-	-	-	W	-	250 ft.
422479	3	14	-	-	BK	-	-	-	R	W	-	100 ft.
422481	7	14	-	-	BK	BL	BN	G	R	W	Y	50 ft.
422482	7	14	-	-	BK	BL	BN	G	R	W	Y	250 ft.
422483	7	14	-	-	BK	BL	BN	G	R	W	Y	500 ft.
422484	7	14	-	-	BK	BL	BN	G	R	W	Y	1000 ft.

TRAILER CABLE - ABS GREEN JACKET

- Jacket is Temperature Rated at -70°F to +185°F
- Resistant to Gasoline, Water Solvents, Abrasion, Cutting, Ozone, and Sunlight
- Exceeds SAE Standards



P/N	CONDUCT.	AWG SIZE	STRANDING	O.D	COLORS				LENGTH
					BK	BN	G	Y	
422310	4	12	65	.700"	BK	BN	G	Y	50 ft.
	2	10	104		R	BL			
	1	8	168			W			
422311	4	12	65	.700"	BK	BN	G	Y	100 ft.
	2	10	104		R	BL			
	1	8	168			W			
422312	4	12	65	.700"	BK	BN	G	Y	250 ft.
	2	10	104		R	BL			
	1	8	168			W			
422313	4	12	65	.700"	BK	BN	G	Y	500 ft.
	2	10	104		R	BL			
	1	8	168			W			
422314	4	12	65	.700"	BK	BN	G	Y	1000 ft.
	2	10	104		R	BL			
	1	8	168			W			

TRAILER CABLE - ISO YELLOW JACKET

- Jacket is Temperature Rated at -70°F to +185°F
- Resistant to Gasoline, Water Solvents, Abrasion, Cutting, Ozone, and Sunlight
- Exceeds SAE Standards



P/N	CONDUCT.	AWG SIZE	STRANDING	O.D	COLORS				LENGTH
					BK	BN	G	Y	
422472	4	12	65	.700"	BK	BN	G	Y	50 ft.
	2	10	104		R	BL			
	1	8	168			W			
422473	4	12	65	.700"	BK	BN	G	Y	100 ft.
	2	10	104		R	BL			
	1	8	168			W			
422474	4	12	65	.700"	BK	BN	G	Y	250 ft.
	2	10	104		R	BL			
	1	8	168			W			
422475	4	12	65	.700"	BK	BN	G	Y	500 ft.
	2	10	104		R	BL			
	1	8	168			W			

TRAILER CABLE - FLAT GRAY JACKET

- Jacket is Temperature Rated at -70°F to +185°F
- Resistant to Gasoline, Water Solvents, Abrasion, Cutting, Ozone, and Sunlight
- Exceeds SAE Standards

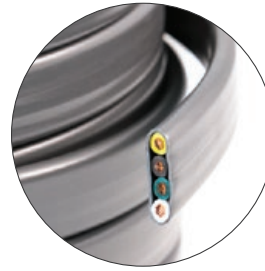

P/N	CONDUCTORS	AWG SIZE	COLORS			LENGTH	
422485	2	10	BK	W		100 ft.	
422486	2	12	BK	W		100 ft.	
422478	2	14	BK	W		1000 ft.	
422487	2	16	BK	W		100 ft.	
422488	3	14	Y	BN	G	100 ft.	
422489	3	16	Y	BN	G	100 ft.	
422480	3	14	BK	W	R	500 ft.	
422490	4	14	Y	BN	G	W	100 ft.
422491	4	16	Y	BN	G	W	100 ft.

PARALLEL WIRE

P/N	LENGTH	COND.	COLORS			
422494	100 ft.	3 / 14 GA	Y	BN	G	
422495	100 ft.	3 / 16 GA	Y	BN	G	
422496	100 ft.	4 / 12 GA	Y	BN	G	W
422497	100 ft.	4 / 14 GA	Y	BN	G	W
422498	100 ft.	6 / 16 GA	Y	BN	G	W



JACKETED PARALLEL PRIMARY WIRE

- Thermoplastic Insulated Wires are Jacketed with a Tough Grey PVC Jacket
- Parallel Construction is Common for Use with Trailers and Vehicles where Space is Limited
- Meets J1128 type GPT

P/N	COND.	AWG	STRAND	CABLE O.D	COLORS		LENGTH
422240	2	14	19	.163" x .286"	BK	W	250 ft.



300 VOLT PORTABLE POWER CABLE

- Type SJE00-WA
- Greater Mechanical Strength and Lighter Weight
- More Resistant to Low Temperatures, Heat, Aging, Abrasion, Chemicals, Oil, Ozone and Water
- Temperature Rating is from -70°C to +105°C
- Meets UL, CSA and OSHA Standards



P/N	COND.	AWG	STRAND	AMPS	O.D.	LENGTH
422271	2	14	41x30	18	.339"	250 ft.
422272	3	14	41x30	18	.360"	250 ft.

POLYETHYLENE SPLIT LOOM

- Split Seam Feature allows for Easy Wire Insertion and Service
- Excellent for High-Heat, High-Abrasion, and Flexible Applications
- UV stabilized
- Will Not Support Combustion

P/N	I.D.	LENGTH
422415	1/4"	100 ft.
422416	3/8"	100 ft.
422417	1/2"	100 ft.
422418	5/8"	100 ft.
422419	3/4"	100 ft.
422420	1"	100 ft.
422636	1-1/4"	50 ft.
422637	1-1/2"	50 ft.
422638	2"	50 ft.



FRAME CLIPS

P/N	DESCRIPTION
492200	3/16" Frame Clips
492201	1/4" Frame Clips
492202	3/8" Frame Clips



CIRCUIT IDENTIFICATION

COLOR	CIRCUIT
White	Ground Return
Black	Clearance, Side Marker & Indent Lamps
Yellow	Left Turn Signal & Hazard Signal
Red	Stop Lamp & Anti-Lock Devices
Green	Right Turn Signal & Hazard Signal
Brown	Tail & License Plate Lamps
Blue	Auxiliary Circuit / ABS Power



WIRE GAUGE SELECTION CHART

12-VOLT SYSTEM		TOTAL LENGTH OF CABLE IN CIRCUIT FROM BATTERY TO MOST DISTANT LAMP									
AMPS (App)	Candle Power	2.5 ft. GA.	5 ft. GA.	10 ft. GA.	20 ft. GA.	30 ft. GA.	40 ft. GA.	50 ft. GA.	60 ft. GA.	80 ft. GA.	100 ft. GA.
1	6	20	20	20	20	20	20	20	20	20	18
1.5	10	20	20	20	20	20	20	20	20	18	18
2	16	20	20	20	20	20	20	18	18	16	16
3	24	20	20	20	20	20	18	18	16	16	14
4	30	20	20	20	20	18	16	16	16	14	12
5	40	20	20	20	18	18	16	14	14	12	12
6	50	20	20	20	18	16	16	14	14	12	12
7	60	20	20	20	18	16	14	14	12	12	10
8	70	20	20	20	16	16	14	12	12	10	10
10	80	20	20	18	16	14	12	12	12	10	10
11	90	20	20	18	16	14	12	12	10	10	8
12	100	20	20	18	16	14	12	12	10	10	8
15	120	20	20	18	14	12	12	10	10	8	8
18	140	20	20	16	14	12	10	10	8	8	8
20	160	20	18	16	12	12	10	10	8	8	6
22	180	20	18	16	12	10	10	8	8	8	6
24	200	20	18	16	12	10	10	8	8	6	6
36	-	20	16	14	10	8	8	8	6	6	4
50	-	18	16	12	10	8	6	6	4	4	2
100	-	14	12	10	6	4	4	2	2	1	0
150	-	14	10	8	4	2	2	1	0	00	000
200	-	12	8	6	4	2	1	0	00	000	0000

NOTE: This Chart is based upon a 10% maximum voltage drop. For a 5% voltage drop, use double the measured wire length. When mechanical strength is a factor, use the next larger wire gauge.

REAR SILL HARNESS

P/N	DESCRIPTION
500304	24"-84" Rear Sill Harness
500305	50"-50" Rear Sill Harness



500304

PIGTAIL HARNESS

P/N	DESCRIPTION
500400	Incandescent (2)S/T/T, (1) Marker
500401	Incandescent (2)S/T/T, (8) Bullet Connectors
500402	Incandescent (3)S/TT, (1) Marker
500403	Incandescent (3)S/T/T, (8) Bullet Connectors
500500	LED (2)S/T/T, (1) Marker
500501	LED (2)S/TT, (8) Bullet Connectors
500502	LED (3)S/T/T, (1) Marker
500503	LED (3)S/T/T, (8) Bullet Connectors
500600	Male Pin (2)S/T/T, (1) Marker
500601	Male Pin (2)S/T/T, (8) Bullet Connectors
500602	Male Pin (3)S/T/T, (1) Marker
500603	Male Pin (3)S/T/T, (8) Bullet Connectors



500503

BAR LAMP HARNESS

P/N	DESCRIPTION
500700	3' Bar Lamp/License Harness
500701	3' Bar Lamp Harness
500702	19' Bar Lamp/License Harness
500703	19' Bar Lamp Harness



500700

MAIN HARNESS

P/N	DESCRIPTION
500130*	30' Main ABS Harness
500140	40' Main ABS Harness
500150	50' Main ABS Harness
500160	60' Main ABS Harness
500017	Socket Adapter with 30' Doubles



500140

* When purchasing for a double trailer, it is recommended that you purchase a socket adapter

MID-TURN HARNESS

P/N	DESCRIPTION
500204*	24"-84" Center Pigtail / Turn Harness
500205*	24"-84" Center Pigtail / Turn Harness with Bullet Connectors
500206*	60"-60" Center Pigtail / Turn Harness
500207	60"-60" Pigtail / Turn Harness with Bullet Connectors
500300	25' S/T/T Lead
500301	25' Pigtail / Turn Extension Harness

* When purchasing a 40', 50', 60' ABS Harness it is recommended that you purchase a center turn harness



JUMPER HARNESS

P/N	DESCRIPTION
500200	5' Pigtail / Clearance Lamp Adapter
500201	5' Pigtail Adapter Jumper
500202	16' Pigtail / Clearance Lamp Adapter
500203	16' Pigtail Adapter Jumper
500800	8" Pigtail / Clearance Lamp Adapter



ABS HARNESS

P/N	DESCRIPTION
500302	12" ABS Adapter
500303	11' ABS Adapter



LAMP PIGTAIL

P/N	DESCRIPTION
500801	Incandescent S/T/T Pigtail with (3) Bullet Connectors
500802	Truck-Lite LED Lamp S/T/T Pigtail with (3) Bullet Connectors
500803	Grote Male Pin S/T/T Pigtail with (3) Bullet Connectors



19 SERIES LAMP PIGTAIL

P/N	DESCRIPTION
500002	8" Male Pin Marker Pigtail with (2) Bullet Connectors



LED MARKER LAMP PIGTAIL

P/N	DESCRIPTION
500009	6" LED Marker Pigtail with (2) Bullet Connectors



10, 15, AND 30 SERIES LAMP PIGTAILS

P/N	DESCRIPTION
500001	8" Pigtail with (2) Bullet Connectors
500010	8" Pigtail (1) Ring, (1) Blunt Cut



MALE PIN THIN LINE PIGTAIL

P/N	DESCRIPTION
500003	8" Male Pin Thin Line with (2) Bullet Connectors



40 SERIES LAMP PIGTAIL

P/N	DESCRIPTION
500006	12" Incandescent Auxiliary Pigtail, (1) Bullet, and (1) Ring
500007	12" Incandescent S/T/T with (3) Bullet Connectors
500011	11" Incandescent Auxiliary Pigtail (1) Ring, and (1) Blunt Cut
500012	11" S/T/T Pigtail (1) Ring, (2) Blunt Cut



40 SERIES LAMP PIGTAIL

With Splash Guard

P/N	DESCRIPTION
500008	8" S/T/T Pigtail with 90° plug-in and (3) Bullet Connectors
500013	8" S/T/T Pigtail with 90° plug-in, (1) Ring, and (2) Blunt Cut



AMP STYLE CONNECTORS

P/N	DESCRIPTION
500014	8" AMP Style (2) Bullet Connectors
500015	8" AMP Style (3) Bullet Connectors
500016	8" AMP Style (1) Ring, (1) Bullet



MALE PIN MARKER LAMP PIGTAIL

P/N	DESCRIPTION
500004	12" Male pin Marker Pigtail with (1) Ring and (1) Bullet
500005	8" Male Pin Marker Pigtail with (2) Bullet



FORKS



Crimp 'N Seal
Non-Locking

Crimp 'N Seal
Locking

Nylon
Non-Locking

Nylon
Locking

Vinyl
Non-Locking

Vinyl
Locking

WIRE RANGE	STUD SIZE	CRIMP 'N SEAL (NON-LOCKING)	CRIMP 'N SEAL (LOCKING)	NYLON (NON-LOCKING)	NYLON (LOCKING)	VINYL (NON-LOCKING)	VINYL (LOCKING)
22-18	6	422363	-	-	422440	422577	422050
22-18	8	422364	422371	-	422441	-	422049
22-18	10	422365	422372	422542	422442	-	422048•
16-14	6	422366	-	-	422443	422565	422053•
16-14	8	422367	422373	-	422444	-	422052•
16-14	10	422368	422374	422548	422445	422564	422051•
12-10	8	422369	422375	-	422446	-	422055
12-10	10	422370	422376	422556	422447	-	422054•
12-10	1/4	-	422377	-	-	-	-

• Item is available packaged, order with suffix "P"

NOTE: Locking Crimp 'n Seal forks are not UL or CSA listed

CRIMP 'N SEAL®

Waterproof Heat Shrink Connectors

- Crimp 'N Seal® Waterproof Connectors Provide an Environmental Seal
- The Tough Polymer Jacket Shrinks while Simultaneously Activating the Adhesive in the Tubing to Completely Encapsulate the Connection
- Easy Installation Steps:



1. STRIP



2. CRIMP



3. HEAT



RINGS



WIRE	STUD	CRIMP 'N SEAL	NYLON	VINYL	BRAZED	HEAT SHRINK	SOLDER & SEAL
22 - 18	6	-	422421	422031•	-	422535	-
22 - 18	8	422018•	422422	422030•	-	-	-
22 - 18	10	422019•	422423	422029•	-	-	-
22 - 18	5/16	-	422576	-	-	-	-
22 - 18	1/4	-	422424	422028•	-	422536	-
16 - 14	6	422020•	422425	422037•	-	-	-
16 - 14	8	422000•	422426	422036•	-	-	422544
16 - 14	10	422001•	422427	422035•	-	-	422545
16 - 14	1/4	422002•	422428	422034•	-	-	422546
16 - 14	5/16	422003•	422429	422033•	-	-	-
16 - 14	3/8	422004•	422430	422032•	-	-	422547
12 - 10	6	-	422581	-	-	-	-
12 - 10	8	422005•	422431	422043	-	-	-
12 - 10	10	422006•	422432	422042•	-	-	422552
12 - 10	1/4	422007	422433	422041•	-	-	422553
12 - 10	5/16	422008•	422434	422040•	-	-	-
12 - 10	3/8	422009•*	422435	422039•	-	-	422554
12 - 10	1/2	422010•	422436	422038•	-	-	422555
8	10	-	-	422575	-	422537	-
8	1/4	-	422437	422025•	-	422538	-
8	3/8	-	422438	422026•	-	422539	-
8	1/2	-	422439	422027•	-	422540	-
6	1/4	-	-	422571	-	-	-
6	5/16	-	-	422572	-	-	-
6	1/2	-	-	422573	-	-	-
4	1/4	-	-	-	422517	-	-
4	3/8	-	-	-	422518	-	-
4	1/2	-	-	-	422519	-	-
2	3/8	-	-	-	422520	-	-
2	1/2	-	-	-	422521	-	-
1/0	3/8	-	-	-	422522	-	-
1/0	1/2	-	-	-	422523	-	-
2/0	3/8	-	-	-	422513	-	-
2/0	1/2	-	-	-	422514	-	-
3/0	3/8	-	-	-	422515	-	-
3/0	1/2	-	-	-	422516	-	-

• Item is available packaged, order with suffix "P"

* Not CSA listed

BUTT SPLICES



Crimp 'N Seal
Brazed



Nylon



Vinyl



Crimp, Heat
& Shrink



Crimp, Shrink
& Solder



Solder
& Seal

WIRE RANGE	CRIMP 'N SEAL (BRAZED)	NYLON	VINYL	CRIMP, HEAT & SHRINK	CRIMP, SHRINK & SOLDER	SOLDER & SEAL
22 - 18	422015•	422448	422047•	-	422559	422543
16 - 14	422016•	422449	422046•	-	422560	422549
12 - 10	422017•	422450	422045•	-	-	422557
8	-	422451	422044•	422541	-	-
6	-	422574	-	-	-	-

• Item is available packaged, order with suffix "P"

BULLET/SNAP PLUGS



Crimp 'N Seal



Nylon



Vinyl

WIRE RANGE	STYLE	STUD SIZE	CRIMP 'N SEAL	NYLON	VINYL
22 - 18	Male	.157	-	422464	422578
22 - 18	Female	.157	-	422465	-
22 - 18	Union	.157	-	-	422580
22 - 18	Female	.180	-	-	422579
16 - 14	Male	.157	422023•	422466	422062•
16 - 14	Female	.157	422024•	422467	422063•
16 - 14	Female	.176	-	422562	422568
16 - 14	Male	.176	-	422563	422567
12 - 10	Male	.157	-	-	422583

• Item is available packaged, order with suffix "P"

NOTE: Crimp 'n Seal plugs are not UL or CSA listed

QUICK-DISCONNECTS



Crimp 'N Seal
Insulated

Crimp 'N Seal
Standard

Nylon
Insulated

Nylon
Standard

Vinyl
Insulated

Vinyl
Standard

WIRE RANGE	STYLE	CRIMP 'N SEAL (INSULATED)	CRIMP 'N SEAL (STANDARD)	NYLON (INSULATED)	NYLON (STANDARD)	VINYL (INSULATED)	VINYL (STANDARD)
22-18	Male	422011•	422387	-	422458	-	422056
22-18	Female	422012•	422388	-	422459	-	422057
16-14	Male	422013•	422389	422454•	422460	-	422058•
16-14	Female	422014•	422390	422455•	422461	-	422059•
12-10	Male	422021•	422391	-	422462	422069	422060•
12-10	Female	422022•	422392	-	422463	422070	422061•

• Item is available packaged, order with suffix "P"

NOTE: Crimp 'n Seal is not UL or CSA listed

COOL-SEAL® CONNECTORS

- Connectors Seal Out Corrosion Causing Moisture
- No Heat Tools Required, Simply Strip & Crimp!
- Installs in a Fraction of the Time of Comparable Heat Shrink Terminals
- Nylon Insulation
- 99.9% ETP Copper Terminal



P/N	DESCRIPTION
422720	22-18 Ga. Cool-Seal Butt Splice
422721	16-14 Ga. Cool-Seal Butt Splice
422722	12-10 Ga. Cool-Seal Butt Splice

SOLDER & SEAL QUICK-CONNECTS

P/N	GAUGE	TYPE
422550	16 - 14	Male
422551	16 - 14	Female



ELECTRICAL CONNECTORS

WIRE END CAPS



P/N	DESCRIPTION
422569	12 Ga. Wire End Cap
422570	14 Ga. Wire End Cap

VINYL QUICK-LOCK CONNECTOR

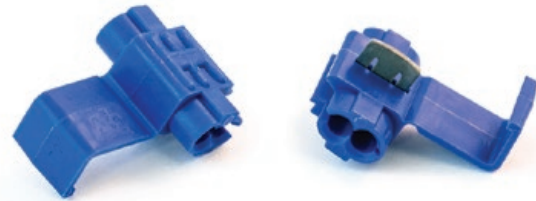

P/N	WIRE RANGE	STUD SIZE
422064	Tap	18 - 14

3 & 4-WAY SPLICES

WIRE	STYLE	CRIMP 'N SEAL	VINYL
22 - 18	3-Way	422378	-
22 - 18	4-Way	422379	-
16 - 14	3-Way	422380	422584
16 - 14	4-Way	422381	422586
12 - 10	3-Way	422382	422585
12 - 10	4-Way	422383	422587



NYLON CABLE TIES

P/N	LENGTH	TENSILE	DESCRIPTION
422071•	4 in	18 lbs	Natural
422072	5 in	30 lbs	Natural
422073•	8 in	50 lbs	Natural
422074	7 in	50 lbs	Natural-Mountable
422075•	14 in	50 lbs	Natural
422076•	14 in	120 lbs	Natural
422077•	4 in	18 lbs	UV Black
422078•	5 in	30 lbs	UV Black
422079•	8 in	50 lbs	UV Black
422080•	14 in	50 lbs	UV Black
422081•	14 in	120 lbs	UV Black
422588	11 in	50 lbs	Natural
422589	11 in	50 lbs	UV Black
422590	12 in	50 lbs	Natural-Releasable
422591	12 in	50 lbs	Black-Releasable



• Item is available packaged, order with suffix "P"

SILICONE SELF-FUSING TAPE

- Revolutionary Alternative to Heat Shrink Tubing
- Forms a Permanent, Moisture Tight Seal
- No Adhesive Residue Upon Removal
- Self-Fusing & Begins Curing Immediately
- Ideal for High Temperature Applications

- Perfect for Battery Terminals, Hose Systems, Color Coding, Garden Hoses, Outside Plant Cable Splices & Grip Enhancement



P/N	DESCRIPTION
421808	Silicone Self-Fusing Tape, Red , 1"x20'
421809	Silicone Self-Fusing Tape, Black , 1"x20'
421810	Silicone Self-Fusing Tape, Blue , 1"x20'

HEAVY-WALL HEAT SHRINK TUBING

- FR-Grade Tubing Meets MIL Spec. 23053/15 Rigid Requirements for Flame Retardancy. This Level of Performance is Now a Requirement in Many Areas of the Transportation Industry
- 3-to-1 Shrink Ratio: Application of Heat Causes an Adhesive Liner to Melt as the tubing shrinks, Forming Intimate Contact with All Underlying Surfaces & Voids to Yield a Watertight Seal
- Recommended for Insulating Splices & Terminations. It is UL listed under the 486 D standard & meets CSA certification requirements



P/N	LENGTH	I.D.	COLOR	WIRE RANGE	MAX. WALL THICKNESS
422166	1.5"	.750"	Black	8 - 1	.105"
422167	1.5"	.750"	Red	8 - 1	.105"
422168	1.5"	1.10"	Black	2 - 4/0	.120"
422169	1.5"	1.10"	Red	2 - 4/0	.120"
422170	6"	.300"	Black	18 - 14	.060"
422171	6"	.400"	Black	14 - 6	.060"
422172	6"	.750"	Black	8 - 1	.105"
422173	6"	.750"	Red	8 - 1	.105"
422174	6"	1.10"	Black	2 - 4/0	.120"
422175	6"	1.10"	Red	2 - 4/0	.120"
422595	48"	1.10"	Black	2 - 4/0	.080"
422596	48"	1.10"	Clear	2 - 4/0	.080"
422597	48"	1.10"	Red	2 - 4/0	.080"

THIN-WALL HEAT SHRINK TUBING

- Opaque Tubing with a 2-to-1 Shrink Ratio
- Easily Assembled Over Components, Connectors or Other Irregular Shapes
- Can be Used as Electrical Insulation Over Cable Splices & Terminations, for Wire Harness Covering, Bundling & Wire Marker Identification
- Tubing Meets or Exceeds the Requirements of MIL-1-23053D/5, Class I, II & III, AMS 3636C & AMS 3637B, and are UL Recognized & CSA Certified



P/N	LENGTH	I.D.	COLOR	WIRE RANGE	MAX. WALL THICKNESS
422159	6"	1/8"	Red	22 - 18	.020"
422160	6"	1/4"	Blue	16 - 14	.025"
422161	6"	5/16"	Yellow	12 - 10	.025"
422592	6"	.187"	Red	22 - 18	.047"
422593	6"	.250"	Blue	16 - 14	.047"
422594	6"	.312"	Yellow	12 - 10	.050"

DUAL-WALL HEAT SHRINK TUBING

- Polyolefin Tubing Can be Used for Sealing Splices & Terminals
- Weatherproofs Your Connections and Provides Strain Relief and Vibration Resistance
- Dual-Wall is an Economical Alternative to Heavy-Wall Tubing in Light-Duty Applications



P/N	LENGTH	I.D.	COLOR	WIRE RANGE	MAX. WALL THICKNESS
422598	6"	.187"	Black	20 - 14	.040"
422162	6"	3/8"	Black	12 - 6	.050"
422163	6"	1/2"	Black	8 - 4	.055"
422164	6"	1"	Black	2 - 4/0	.100"
422165	6"	1"	Red	2 - 4/0	.100"

POST-TOP BATTERY TERMINALS

- Copper Construction Provides a Low Resistance Connection
- Cable Size, Polarity, and Tool Die Codes are Raised Characters for Increased Legibility
- Tin Plated with Color Coding
- For Maximum Durability, Use with Heavy-Wall Heat Shrink Tubing in 1-1/2" Pieces

RIGHT ELBOW POST TOP



P/N	CABLE	POLARITY	TOOL DIE CODE
422089	1/0	Neg	Black E-A
422088	1/0	Pos	Black E-A
422091	2/0	Neg	Orange A-C
422090	2/0	Pos	Orange A-C
422093	3/0	Neg	Purple A-B
422092	3/0	Pos	Purple A-B
422506	4/0	Neg	Yellow A-A
422507	4/0	Pos	Yellow A-A

LEFT ELBOW POST TOP



P/N	CABLE	POLARITY	TOOL DIE CODE
422083	1/0	Neg	Black E-A
422082	1/0	Pos	Black E-A
422085	2/0	Neg	Orange A-C
422084	2/0	Pos	Orange A-C
422087	3/0	Neg	Purple A-B
422086	3/0	Pos	Purple A-B
422508	4/0	Neg	Yellow A-A
422509	4/0	Pos	Yellow A-A

FLAG POST TOP



P/N	CABLE	POLARITY	TOOL DIE CODE
422105	1/0	Neg	Black E-A
422106	1/0	Pos	Black E-A
422107•	2/0	Neg	Orange A-C
422108•	2/0	Pos	Orange A-C
422109•	3/0	Neg	Purple A-B
422110•	3/0	Pos	Purple A-B
422111	4/0	Neg	Yellow A-A
422112	4/0	Pos	Yellow A-A

STRAIGHT POST TOP



P/N	CABLE	POLARITY	TOOL DIE CODE
422504	6	Universal	Green J-H
422505	1-2	Universal	Green J-H
422094•	4	Universal	Green J-H
422096	1-2	Neg	Pink H-H
422095	1-2	Pos	Pink H-H
422098•	1/0	Neg	Black E-A
422097•	1/0	Pos	Black E-A
422100•	2/0	Neg	Orange A-C
422099•	2/0	Pos	Orange A-C
422102	3/0	Neg	Purple A-B
422101	3/0	Pos	Purple A-B
422104	4/0	Neg	Yellow A-A
422103	4/0	Pos	Yellow A-A

• Items are available packaged. Order with suffix "P"

BATTERY TERMINALS

SOLDER POST-TOP BATTERY TERMINALS

- Yellow Brass
- Lead Plated for Superior Corrosion Resistance
- Marine Terminals have 5/16"-18 Stud Thread

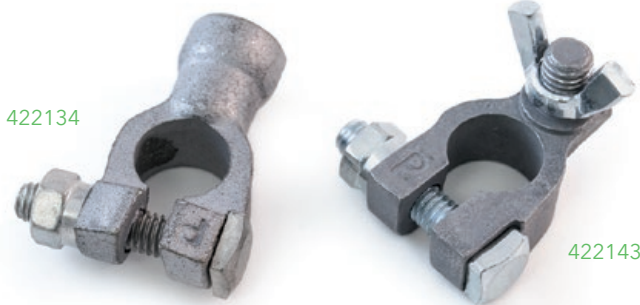

P/N	CABLE SIZE	POLARITY
422131	3-4	Universal
422133	1/0	Negative
422134	1/0	Positive
422135	2/0 - 3/0	Negative
422136	2/0 - 3/0	Positive
422143	Marine Terminal	Positive
422144	Marine Terminal	Negative

FLAG STUD TOP

- Split Barrels - Yellow Brass
- Lead Plated for Superior Corrosion Resistance



P/N	CABLE SIZE	POLARITY
422137	1-2	Universal
422138	1/0	Negative
422139	1/0	Positive
422140	2/0 - 3/0	Negative
422141	2/0 - 3/0	Positive

EMERGENCY STUD TOP



P/N	DESCRIPTION	CABLE	POLARITY
422128	Automotive, Cast Lead, No Plating	6-2/0	Universal
422142•	Heavy Duty, Yellow Brass, Lead Plated	6-3/0	Universal

• Item is available packaged. Order with suffix "P"

ANTI-CORROSION RINGS

- Felt Material Helps Protect Both Battery and Battery Terminal from Corrosion
- For Use with Post-Top, Stud-Top, and Side-Mount Batteries
- Comes in a Package of 100 Pieces with Pre-Applied Grease
- Color-Coded for Polarity



P/N	BATTERY TYPE	COLOR / POLARITY
422412	Post Top / Stud Top	Red / Positive
422413	Side Mount	Black / Negative
422414	Side Mount	Red / Positive

POWER TERMINALS

- Stamped from 99.9% ETP Copper and Tin-Plated
- Color Coded for Ease of Installation
- Anti-Rotational Indents Allow Stacking and Grips the Battery Securely

STUD TOP



P/N	CABLE	POLARITY	TOOL DIE CODE
422113	4	Universal	Grey J-H
422114	1-2	Universal	Pink H-H
422115	1/0	Universal	Black E-A
422116	2/0	Universal	Orange A-C
422120	3/0	Universal	Purple A-B
422117	4/0	Universal	Yellow A-A

STUD TOP

Cast Terminals



P/N	CABLE	POLARITY	TOOL DIE CODE
422393	4	Universal	Green J-H
422394	1-2	Universal	Pink H-H
422395	1/0	Universal	Black E-A
422396	2/0	Universal	Orange A-C
422397	3/0	Universal	Purple A-B
422398	4/0	Universal	Yellow A-A

STUD TOP FLAG SPLICE



P/N	CABLE	POLARITY	TOOL DIE CODE
422118	1/0	Universal	Black E-A
422119	2/0	Universal	Orange A-C
422121	3/0	Universal	Purple A-B
422122	4/0	Universal	Yellow A-A

STUD TOP FLAG SPLICE

Cast Terminals



P/N	CABLE	POLARITY	TOOL DIE CODE
422399	1/0	Universal	Black E-A
422400	2/0	Universal	Orange A-C
422401	3/0	Universal	Purple A-B
422402	4/0	Universal	Yellow A-A

SIDE MOUNT BATTERY TERMINALS

P/N	CABLE	POLARITY	TOOL DIE CODE
422403	4	Universal	Grey K-K
422404	2	Universal	Brown J-H
422405	1	Universal	Green J-H
422406	1/0	Universal	Pink H-H



SIDE TERMINAL CHARGING POST

P/N	POLARITY
422524	Negative
422525	Positive



SIDE MOUNT BOLTS

Zinc-Plated Steel

P/N	DESCRIPTION
422123	Long Side Mount Bolt with Screw
422130	Side Mount Bolt, OEM

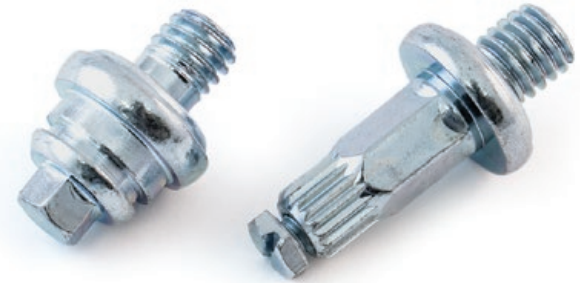

STEEL BOLT & SHOULDER NUT

P/N	SIZE	PLATED
422407	5/16"-18 x 1 1/4"	Lead
422408	5/16"-18 x 1 1/4"	Zinc
422409	5/16"-18 x 1 1/2"	Lead
422410	5/16"-18 x 1 1/2"	Zinc



STUD NUTS

- Group 31 Batteries - 3/8"-16 Thread

P/N	DESCRIPTION	POLARITY
422124	Black Amodel	Negative
422125	Red Amodel	Positive
422126•	Stainless Steel	Universal

• Item is available packaged. Order with suffix "P"

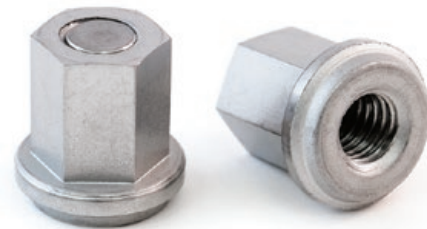

SOLID LEAD STUD TO POST CONVERTER

P/N	DESCRIPTION	POLARITY
422129•	Converter	Universal

• Item is available packaged. Order with suffix "P"



POWER LUGS & SPLICES

- Increased Wall Thickness Yields Greater Strength and Conductivity
- Tin Plated Copper Offers Corrosion Resistance
- Crimps with the Same Die Setting as Corresponding Size Battery Terminal

HEAVY DUTY POWER LUGS



P/N	CABLE	STUD SIZE	TOOL DIE CODE
422345	4	1/4	Green J-H
422346	4	5/16	Green J-H
422347	1-2	1/4	Pink H-H
422348	1-2	3/8	Pink H-H
422349	1/0	3/8	Black E-A
422350	1/0	1/2	Black E-A
422351	2/0	3/8	Orange A-C
422352	2/0	1/2	Orange A-C
422353	3/0	3/8	Purple A-B
422354	3/0	1/2	Purple A-B
422355	4/0	3/8	Yellow A-A
422356	4/0	1/2	Yellow A-A

HEAVY DUTY POWER SPLICES



P/N	CABLE SIZE	TOOL DIE CODE
422357	4	Green J-H
422358	1-2	Pink H-H
422359	1/0	Black E-A
422360	2/0	Orange A-C
422361	3/0	Purple A-B
422362	4/0	Yellow A-A

LIGHT DUTY STARTER LUGS

Unplated



LIGHT DUTY CABLE SPLICES



P/N	CABLE SIZE	TOOL DIE CODE
422145	6	Blue M-K
422146	4	Grey K-K
422147	2	Brown J-H
422148	1	Green J-H
422149	1/0	Pink H-H
422150	2/0	Black E-A
422151	3/0	Orange A-C
422152	4/0	Purple A-B

P/N	CABLE	STUD SIZE	TOOL DIE CODE
422176	6	1/4"	Blue M-K
422177	6	5/16"	Blue M-K
422178	4	1/4"	Grey K-K
422179	4	5/16"	Grey K-K
422180	2	5/16"	Brown J-H
422181	2	3/8"	Brown J-H
422182	1	5/16"	Green J-H
422183•	1	3/8"	Green J-H
422184	1/0	3/8"	Pink H-H
422185	1/0	1/2"	Pink H-H
422186•	2/0	3/8"	Black E-A
422187•	2/0	1/2"	Black E-A
422188•	3/0	3/8"	Orange A-C
422189	3/0	1/2"	Orange A-C
422190•	4/0	3/8"	Purple A-B
422191•	4/0	1/2"	Purple A-B

• Item is available packaged. Order with suffix "P"

HEAVY DUTY STARTER LUGS



P/N	STUD SIZE	GAUGE
422510	3/8"	4
422511	1/2"	4
422512	1/2"	1-2

SOLDER SLUGS



P/N	GAUGE	COLOR
422527	6	Grey
422528	4	Grey
422529	2	Green
422530	2	Pink
422531	1/0	Black
422532	2/0	Orange
422533	3/0	Purple
422534	4/0	Yellow

SOLDER FLUX



P/N	DESCRIPTION
422526	4 oz Solder Flux

GROUND STRAPS

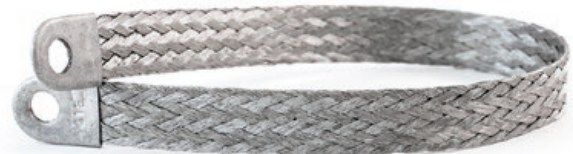

P/N	LENGTH	GAUGE
422639	12"	4
422640	18"	4

SAFE-MATE™ INDUSTRIAL BATTERY CONNECTORS

- High-Impact Polycarbonate Housing Prevents Breakage
- Silver-Plated Copper Contacts Deliver Maximum Current & Long Life
- Contact Marking Provides Step-by-Step Guide to Installation
- Universal Connector: Use as Male or Female End



P/N	DESCRIPTION	AMP RATING	COLOR	CABLE SIZE	I.D. CONTACT
422192	Battery Connector	50	Grey	6	.221
422193	Battery Connector	50	Grey	12-10	.136
422194	Battery Connector	175	Grey	1/0	.437
422195	Battery Connector	350	Grey	2/0	.484
422196	Dust Cover	50	Black	-	-
422197	Dust Cover	175	Black	-	-
422198	Dust Cover	350	Black	-	-

CROSS-OVER CABLE STUD TOP



P/N	LENGTH	CABLE SIZE	POLARITY
422153	8"	1/0	Negative
422154	8"	1/0	Positive
422155	16"	1/0	Negative
422156	16"	1/0	Positive

TOP STUD TO TOP STUD



P/N	LENGTH	GAUGE
422629	12"	2/0
422630	15"	2/0
422631	18"	2/0
422633	8"	2/0

CROSS-OVER CABLE POST TOP



P/N	LENGTH	CABLE SIZE	POLARITY
422157	8"	2/0	Universal
422158	12"	2/0	Universal

TOP POST TO TOP POST



P/N	LENGTH	GAUGE
422620	12"	1
422627	10"	2/0

SWITCH TO STARTER



P/N	LENGTH	GAUGE
422605	15"	4
422606	24"	4
422607	36"	4
422608	40"	4
422621	10"	1
422623	15"	1
422624	18"	1
422628	12"	2/0
422632	8"	2/0

TOP POST TO SOLENOID



P/N	LENGTH	GAUGE
422599	12"	4
422600	15"	4
422601	19"	4
422602	24"	4
422603	30"	4
422610	16"	1
422611	19"	1
422612	22"	1
422614	30"	1
422615	37"	1
422616	48"	1
422617	65"	1
422618	9"	1

CIRCUIT BREAKERS

SNAP-IN CIRCUIT BREAKERS

- Automatic Reset
- 12 Volt
- Meets SAE J553
- Type 1

P/N	AMPS	MOUNTING
422765	8A	Snap-In
422762	10A	Snap-In
422655	15A	Snap-In
422656	20A	Snap-In
422763	25A	Snap-In
422657	30A	Snap-In
422658	40A	Snap-In
422764	50A	Snap-In

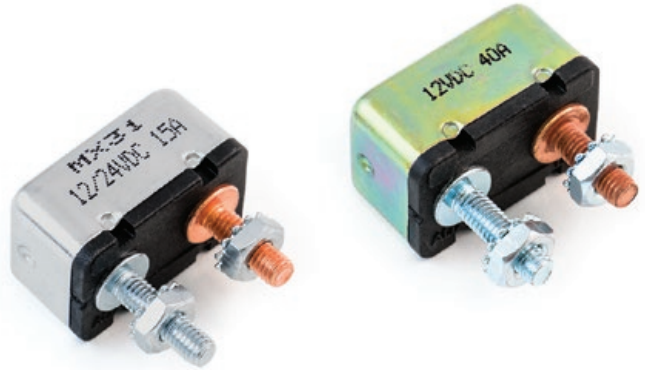

CIRCUIT BREAKERS WITH VERTICAL METAL BRACKET

- Automatic Reset
- 12 Volt
- Meets SAE J553
- Type 1

P/N	AMPS	MOUNTING
422767	10A	Vertical Metal Bracket
421141	15A	Vertical Metal Bracket
421142	20A	Vertical Metal Bracket
422770	25A	Vertical Metal Bracket
421143	30A	Vertical Metal Bracket
421144	40A	Vertical Metal Bracket
422773	50A	Vertical Metal Bracket

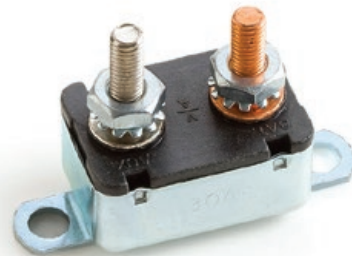

CIRCUIT BREAKERS WITH PLASTIC METAL BRACKET

- Automatic Reset
- 12 Volt
- Meets SAE J553
- Type 1

P/N	AMPS	MOUNTING
422780	5A	Vertical Plastic Bracket
422766	10A	Vertical Plastic Bracket
422774	15A	Vertical Plastic Bracket
422775	20A	Vertical Plastic Bracket
422776	25A	Vertical Plastic Bracket
422777	30A	Vertical Plastic Bracket
422778	35A	Vertical Plastic Bracket
422779	40A	Vertical Plastic Bracket
422781	50A	Vertical Plastic Bracket



SURFACE-MOUNT CIRCUIT BREAKERS

- Manual Reset Button
- Meets SAE J1625
- Automotive Type 3
- Waterproof

P/N	AMPS	MOUNTING
422699	150A	Surface Mount
422700	100A	Surface Mount
422701	120A	Surface Mount
422702	60A	Surface Mount
422703	80A	Surface Mount



FUSE CLIP CIRCUIT BREAKERS

- Type 1
- 12 Volt
- Plastic Body
- Meets SAE J553
- Must be Disconnected from Power Source to Reset

P/N	DESCRIPTION
422782	10A Type 2 Fuse Clip Circuit Breaker
422783	15A Type 2 Fuse Clip Circuit Breaker
422784	40A Type 2 Fuse Clip Circuit Breaker

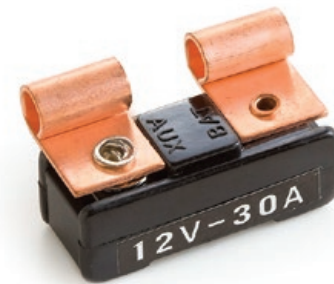

PLUG-IN CIRCUIT BREAKERS

- Type 1
- 12 Volt
- Terminals are Prescored in order to Accommodate Various Applications and Installations
- Must be Disconnected from Power Source to Reset
- Meets SAE J553

P/N	AMPS
422785	10A Plug-In Circuit Breaker
422786	15A Plug-In Circuit Breaker
422787	20A Plug-In Circuit Breaker
422788	25A Plug-In Circuit Breaker
422789	30A Plug-In Circuit Breaker

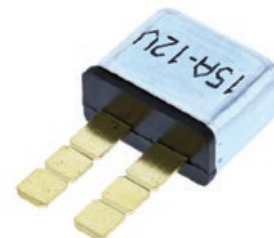

IN-LINE FUSE HOLDER For AGC Style Fuses

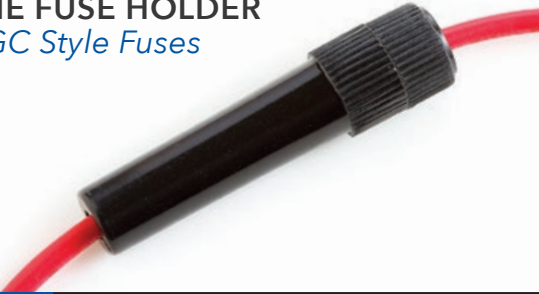

P/N	FUSE INCLUDED	GAUGE
422752	None	12 GA
422750	20 AMP	12 GA
422753	30 AMP	10 GA
422754	None	10 GA

IN-LINE FUSE HOLDER For Standard ATO Style Fuses



P/N	FUSE INCLUDED	GAUGE
422751	None	12 GA
422755	20 AMP	12 GA

AGC GLASS FUSE

- For Use with In-Line Holders and 1/4" Clips
- Rated for 250V or 32V
- 1/4" x 1-1/4" Long Body



P/N	AMPS	VOLTS
422790	1A	250V
422791	2A	250V
422792	3A	250V
422793	4A	250V
422794	5A	250V
422795	7.5A	250V
422796	10A	32V
422797	15A	32V
422798	20A	32V
422799	25A	32V
422800	30A	32V

SFE GLASS FUSE

- (SFE) Society of Fuse Engineers
- UL Listed
- For Use with In-Line Holders & 1/4" Clips
- Rated for 32V



P/N	AMPS	LENGTH
422803	4A	5/8"
422804	6A	3/4"
422805	7.5A	7/8"
422806	9A	7/8"
422807	14A	1-1/16"
422808	20A	1-1/4"
422810	30A	1-7/16"

AGX GLASS FUSE

- For Use with In-Line Holders and 1/4" Clips
- 1/4" x 1-1/4" Long Body

P/N	AMPS	VOLTS
422801	20A	125V/250V
422802	30A	250V



ATC/ATO® FUSE

- Meets J1284 and ISO 8820-3 Standards
- Rated for 32V

P/N	AMPS	COLOR
422811	3A	Violet
422812	4A	Pink
422813	5A	Tan
422814	7.5A	Brown
422815	10A	Red
422816	15A	Blue
422817	20A	Yellow
422818	25A	Clear
422819	30A	Green

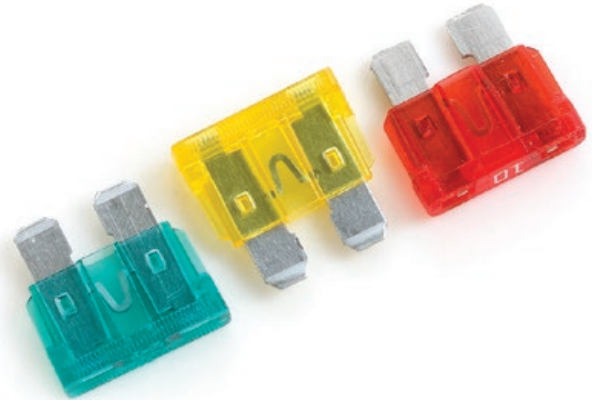

MINI™/ATM BLADE FUSE

- Meets J2077 and ISO 8820-3 Standards
- Rated for 32V

P/N	AMPS	COLOR
422820	2A	Gray
422821	3A	Violet
422822	4A	Pink
422823	5A	Tan
422824	7.5A	Brown
422825	10A	Red
422826	15A	Blue
422827	20A	Yellow
422828	25A	Clear
422829	30A	Green



MAXI™ FUSE

- Meets SAE J1888 and ISO 8820-3 Standards
- Rated for 32V

P/N	AMPS	COLOR
422830	20A	Yellow
422831	30A	Green
422832	40A	Amber
422833	50A	Red
422834	60A	Blue
422835	70A	Tan
422836	80A	Clear



CRIMPER, CUTTER, STRIPPER

P/N	LENGTH	WEIGHT
422199	9-3/8"	8.9 oz

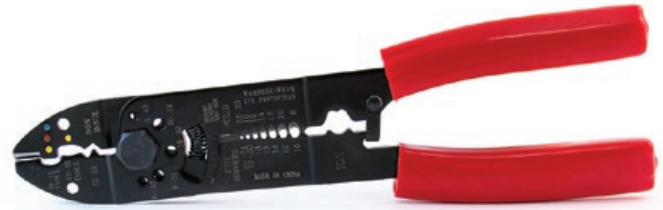

COMPOUND-ACTION CONTROLLED CYCLE TOOL

- Elliptical Shaped
- Nests for Crimping Insulated Terminals
- Blue Handles
- Wire Range: 22-10

P/N	LENGTH	WEIGHT
422200	9-1/8"	12.4 oz



ROTARY CABLE STRIPPER

- 8 AWG
- 400 MCM

P/N	LENGTH	WEIGHT
422202	5-3/8"	4.9 oz



HEAVY DUTY CABLE CUTTERS

- Machine Blade Surfaces Eliminate Nicking & Binding
- Precision Edge Design Provides Easy Cutting



P/N	DESCRIPTION	LENGTH	WEIGHT
422204	Cable Cutter, 350 MCM Maximum	16-1/2"	3.5 lbs
422209	Compact Cable Cutter, 2/0 Maximum	7-3/8"	12 oz

ELECTRIC HEAT GUN

- 2 Temperature Settings: 750°F and 1100°F
- Features a Fold-Down Stand for Hands Free Use
- No Cool-Down Time Required
- 115 Volt AC



P/N	LENGTH	WEIGHT
422205	9-3/4"	1.9 lbs

BUTANE POWER TORCH

- Includes a Stand for Hands Free Operation
- Self-Igniting Torch Uses Refillable Butane Fuel
- Tank Capacity Provides Approximately 70 Minutes of Usage



P/N	LENGTH	WEIGHT
422206	6"	14 oz

PROFESSIONAL CRIMPING TOOL

- Crimp Tool for Battery Terminals, Lugs & Connectors
- Cable Sizes 8 through 4/0
- Compound Action Exerts Maximum Force for Fast, Reliable Crimps
- One Screw Adjustment Provides Easy Calibration to Compensate for Die Wear
- Diamond Shape Crimp Compresses All Strands Together to Form a Solid Mass of Copper, Assuring a Low Resistance Connection
- The Quick Release Lever Allows Tool to Open at Any Time



P/N	LENGTH	WEIGHT
422207	25"	5.9 lbs

COMPACT CRIMPING TOOL

- Hammer Type
- Crimps Lugs & Terminals from 6 GA to 4/0 GA



P/N	HEIGHT	WEIGHT
422208	3-3/4"	1.5 lbs

CABLE TIE TOOL & KIT

- Kit Includes Tie Tool, 8" UV Black Ties (x50), 5-1/2" Natural Ties (x100), and Mounting Bases (x10)



P/N	DESCRIPTION
422210	Cable Tie Installation Tool
422211	Cable Tie Kit

SOLDER & SEAL KIT

- Includes Popular Styles & Sizes of Rings, Butt Connectors, Quick-Connects. Plus, 3 Sizes of Heat Shrink Tubing and a Heat Gun

- 422206 x1
- 422592 x1
- 422593 x1
- 422594 x1
- 422543 x10
- 422545 x10
- 422546 x10
- 422547 x10
- 422549 x10
- 422550 x10
- 422551 x10
- 422552 x10
- 422553 x10
- 422554 x10
- 422557 x10



P/N	DESCRIPTION
422561	Solder & Seal Kit

CRIMP 'N SEAL® SPLICE KIT

- Red 22-18 Butt Splices (x15)
- Blue 16-14 Butt Splices (x25)
- Yellow 12-10 Butt Splices (x10)
- Crimping Tool 422200



P/N	DESCRIPTION
422212	Crimp 'n Seal Splice Kit

CRIMP 'N SEAL® WATERPROOF WIRING KIT

- 80-Piece Assortment of the Most Popular Rings, Forks, and Quick-Disconnect Terminals
- Includes Multi-Purpose Tool 422199



P/N	DESCRIPTION
422213	Crimp 'n Seal Wiring Kit

DELUXE CRIMP 'N SEAL® WATERPROOF WIRING KIT

- 500-Piece Assortment of the Most Popular Rings, Forks, and Quick-Disconnect Terminals
- Includes Crimping Tool 422200, Portable Butane Torch 422206, Cable Tie Installation Tool 422210, and 8" UV Black Cable Ties (x100)



P/N	DESCRIPTION
422214	Deluxe Crimp 'n Seal Wiring Kit

ELECTRICAL TOWER RACK DISPLAY

- 3-Panel Display Rack on Wheels
- Assortment Includes a Mix of Various Popular Connector Types & Sizes
- Products are Packaged in Clear Bags for Easy Part Identification
- Includes 6" Peg Hooks and Plan-o-Gram for Arranging Products on Rack



P/N	DESCRIPTION
421998	Tower Rack ONLY
421999	Tower Rack with Electrical Assortment

ASSORTMENT INCLUDES:	
422001P x60	422052P x300
422002P x60	422053P x300
422003P x60	422054P x150
422004P x60	422058P x300
422006P x60	422059P x300
422007P x60	422060P x150
422008P x60	422061P x150
422009P x60	422062P x300
422014P x60	422063P x150
422015P x60	422064P x60
422016P x60	422094P x12
422017P x60	422097P x12
422025P x60	422098P x12
422026P x60	422099P x12
422027P x60	422100P x12
422028P x300	422107P x12
422029P x300	422108P x12
422030P x300	422109P x12
422031P x300	422110P x12
422032P x300	422126P x60
422033P x300	422129P x30
422034P x300	422142P x12
422035P x300	422183P x30
422036P x300	422186P x30
422037P x300	422187P x30
422038P x150	422188P x30
422039P x150	422190P x30
422040P x150	422191P x30
422041P x150	422071P x600
422042P x150	422073P x600
422044P x60	422075P x600
422045P x150	422076P x300
422046P x300	422077P x600
422047P x300	422078P x600
422048P x300	422079P x600
422051P x300	422080P x600
	422081P x300



STOP LIGHT SWITCH

- Meets the Requirements of DOT 121
- Brass Body Resists Corrosion
- Rated at a Full 24 Amp Load, 12 Volt
- Features Silver and Cadmium Contacts for Long Life and Low Voltage Drop
- Installs with a Deep Socket
- 1/4"-18 NPTF
- 3-5 PSI
- Add Prefix "P" for Pre-Coated Pipe Threads



P/N	DESCRIPTION
38013	Stop Light Switch
38053	Sealed Stop Light Switch

LOW PRESSURE WARNING

- Closes at 60 PSI Descending Pressure
- Brass Body Resists Corrosion
- Rated at 5 Amps, 12 volt
- Color Coded – Yellow
- Installs with a Deep Socket
- 1/8"-27 NPTF
- Add Prefix "P" for Pre-Coated Pipe Threads



P/N	DESCRIPTION
38033	Low Pressure Switch, Screw Terminals
38035	Low Pressure Switch, Blade Terminals

ABS ACCESSORY SWITCH

- Allows Sharing of the Blue Circuit
- Ensures Full Capacity of Blue Circuit is Delivered to ABS Unit When Vehicle is Rolling Down the Road
- Rated at 15 Amps, 12 Volt
- 1/8"-27 NPTF



P/N	DESCRIPTION
38042	Switch without Boot, 1/4" Slide Terminals
38046	Switch with Boot, 12 ga. x 24" Wire Leads
38043	Anchor Tee for Switch, 1/2" Tubing
38044	Anchor Tee for Switch, 3/8" Tubing

STOP LAMP SWITCHES

- Normally Off
- Operates at 60-120 PSI
- Single Pole, Single Throw
- Contact Closed at Rising Pressure

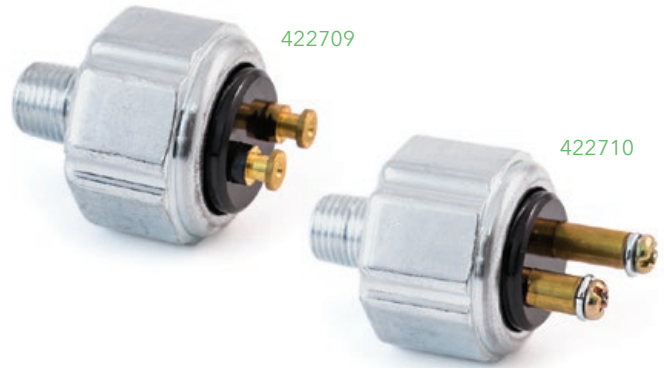

P/N	DESCRIPTION
422709	Stop Lamp Switch, Terminal Posts
422710	Stop Lamp Switch, 2 Screws

LOW PRESSURE SWITCH

- 12 or 24 Volt
- 1/8" NPT
- Circuit Normally Closed at 0 PSI



P/N	DESCRIPTION
401238	Actuates at 55 PSI
401239	Actuates at 66 PSI

SERVICE CIRCUIT STOP LIGHT SWITCH

- 12 or 24 Volt
- 1/4" NPT
- Actuates at 3-5 PSI
- Circuit Normally Open at 0 PSI



P/N	DESCRIPTION
401240	Service Circuit Stop Light Switch

TRAILER EMERGENCY STOP LIGHT SWITCH

- 12 or 24 Volt
- 5 AMPS
- 1/8" NPT
- Single Pole, Double Throw
- Actuates at 55 PSI
- Circuit Normally One Open & One Closed



P/N	DESCRIPTION
401241	Trailer Emergency Stop Light Switch

SL-4 STOP LIGHT SWITCH

- Normally Open at 0 PSI
- Normally Closed at 5 PSI
- 1/4" PT Supply

P/N	DESCRIPTION
401230	SI-4 Stop Light Switch

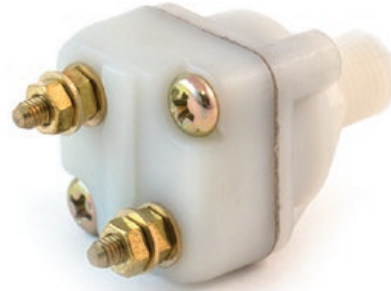

TOGGLE SWITCH, ON - OFF - ON

- 12 Volt
- 50 AMP
- 3 Screw Terminals
- Includes Face Plate

P/N	DESCRIPTION
422643	On-Off-On Toggle Switch



TOGGLE SWITCH, ON - ON

- 12 Volt
- 50 AMP
- 3 Screw Terminals
- 1-1/2" Handle

P/N	DESCRIPTION
422645	On-On Toggle Switch



TOGGLE SWITCH, PUSH-PULL

- 6-28 Volt
- 75 AMP
- 2 Screw Terminals

P/N	DESCRIPTION
422651	Push-Pull Toggle Switch

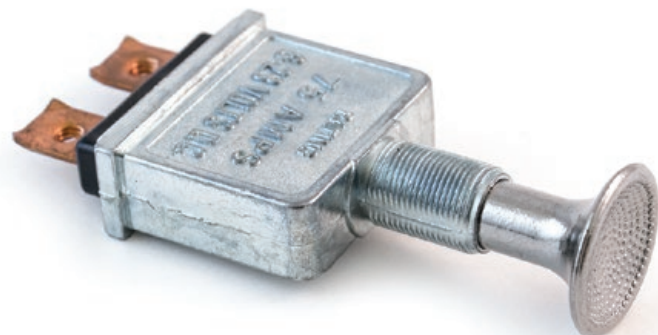

PRECISION BALL, SCREW TERMINAL

- Normally Open

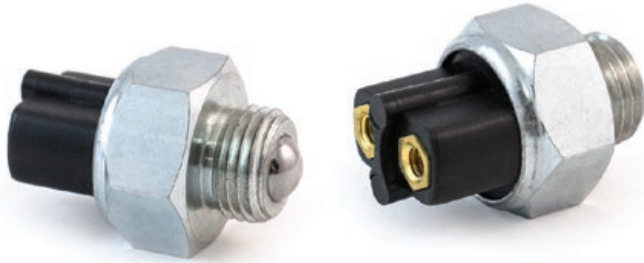

P/N	DESCRIPTION
422685	Precision Ball

NEUTRAL/BACK-UP SWITCH

- Normally Open

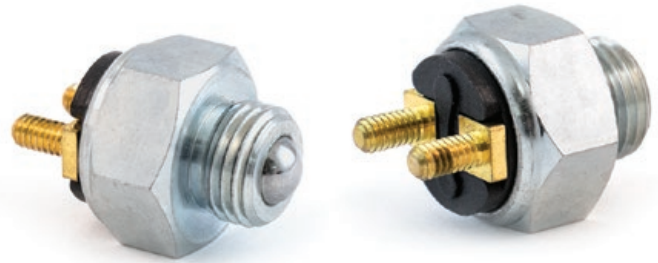

P/N	DESCRIPTION
422686	Neutral/Back-Up Switch

LOW AIR BUZZER

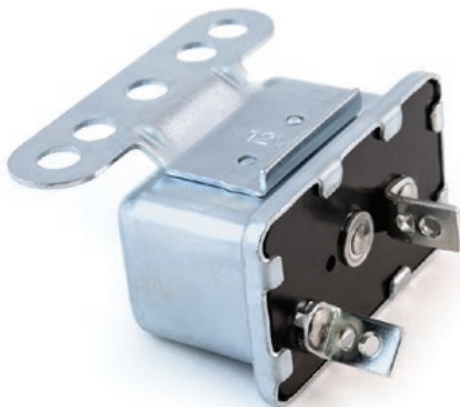

P/N	DESCRIPTION
422687	Low Air Buzzer

DIMMER SWITCH



P/N	DESCRIPTION
422690	Dimmer Switch

STARTER SOLENOIDS

- 12 Volt Continuous
- SPST
- No / Off / On
- Insulated
- 85 AMPS

P/N	DESCRIPTION
421140	Starter Solenoid - Continuous
422688	Starter Solenoid - Intermittent



421140

IGNITION SWITCHES



P/N	DESCRIPTION	FUNCTION	TERMINALS	SWITCH
422648	Ignition Switch	Acc/Off/On - Acc/Start	4 Studs	Key
422649	Universal Ignition Switch	Off/On	2 Screws	Key
422661	4-Position Ignition Switch	Acc/Off/On - Acc/Start	7 Blades	Key
422662	4-Position Ignition Switch	Acc/Off/On - Acc/Start	4 Studs	Lever
422663	Ignition Starter Switch	Acc/Off/On - Acc/Start	11 Blades	Key

TOGGLE SWITCHES

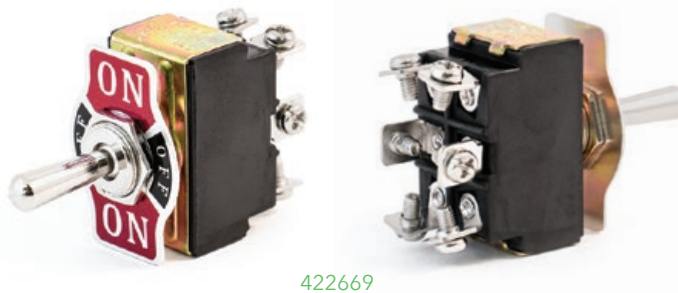

P/N	TYPE	FUNCTION	TERMINALS	AMPS	VOLTS
422664	Double Pole, Single Throw	On/Off	4 Screws	25	12
422665	Double Pole, Double Throw	On/On	6 Screws	25	12
422666	Double Pole, Double Throw	On/On	6 Blades	25	12
422667	Double Pole, Double Throw	On/Off/On	6 Screws	35 Inductive	25 Lamplload
422668	Double Pole, Double Throw	On/Off/On	6 Blades	25	12
422669	Double Pole, Double Throw	Mom. On/Off/Mom. On	6 Screws	25	12
422671	Double Pole, Double Throw	Mom. On/Off/Mom. On	6 Blades	25	12
422672	Single Pole, Single Throw	On/Off	5 Blades	50	-
422642	Single Pole, Single Throw	On/Off	5 Screws	50	12
422673	Single Pole, Single Throw	On/Off	2 Blades	50	12
422674	Single Pole, Double Throw	Mom. On/Off/Mom. On	3 Screws	50	12
422675	Single Pole, Single Throw	On/Off	2 Screws	20	12
422676	Single Pole, Single Throw	On/Off	2 Blades	25	12
422677	Single Pole, Double Throw	On/On	3 Screws	25	12
422678	Single Pole, Double Throw	Mom. On/Off/Mom. On	3 Screws	20	12
422679	Single Pole, Double Throw	On/Off/On	3 Screws	25	12
422680	Single Pole, Double Throw	On/Off/On	3 Blades	25	12

MOMENTARY PUSH SWITCHES

- 12 Volt
- 2 Screw Terminals
- Normally Off

P/N	DESCRIPTION
422681	Momentary Push Switch, 60A
422682	Momentary Push Switch, 60A
422684	Momentary Push Switch, 15A



2-SPEED HI/LO AXLE LIMIT SWITCH

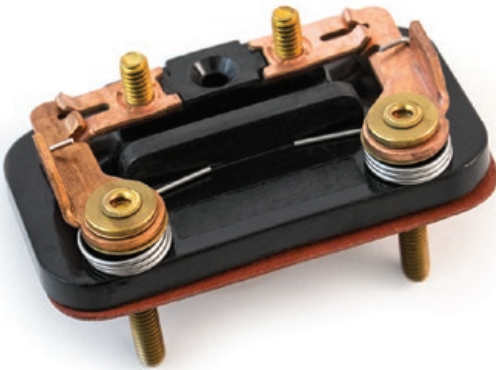

P/N	DESCRIPTION
422652	2-Speed Hi/Lo Axle Limit Switch

2-SPEED HI/LO AXLE SWITCH

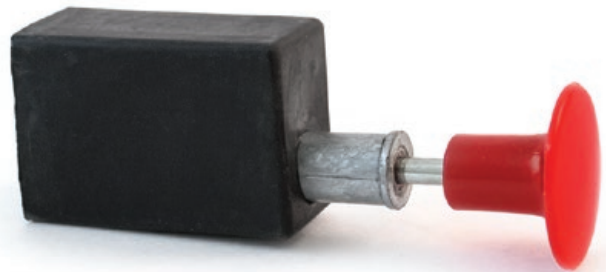

P/N	DESCRIPTION
422653	2-Speed Hi/Lo Axle Switch

PUSH-PULL SWITCHES

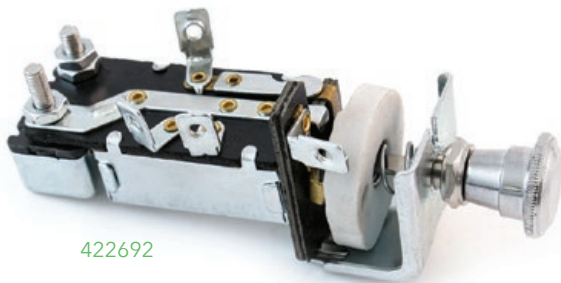

P/N	DESCRIPTION	FUNCTION	AMPS
422692	Push-Pull Switch	Off/On/On	20
422693	Push-Pull Switch with Fuse	Off/On/On	15
422694	Push-Pull Switch	Off/On/On	15
422695	Push-Pull Switch	Off/On	15

MASTER DISCONNECT SWITCHES

- Voltage Range 6-36 VDC



P/N	TYPE	FUNCTION	TERMINALS	AMPS
422696	Single Pole, Single Throw	Off/On	3/8"-16 Studs (x2)	180
422697	Double Pole, Single Throw	Off/On	3/8"-16 Studs (x2) and #10 Studs (x2)	180
422698	Master Disconnect Switch Face Plate, Off/On			

AIR PRESSURE SWITCH

- Normally Closed
- Opens at 60-70 PSI



P/N	DESCRIPTION
422705	Air Pressure Switch

OIL PRESSURE/ELECTRIC CHOKE SWITCH

- Normally Off
- On at 2-6 PSI
- 1/8"-27 NPTF
- Insulated
- SPST



P/N	DESCRIPTION
422707	Oil Pressure/Electric Choke Switch

LP-3 LOW PRESSURE INDICATOR

- Normally Closed at 0 PSI
- Normally Opens at 60 PSI

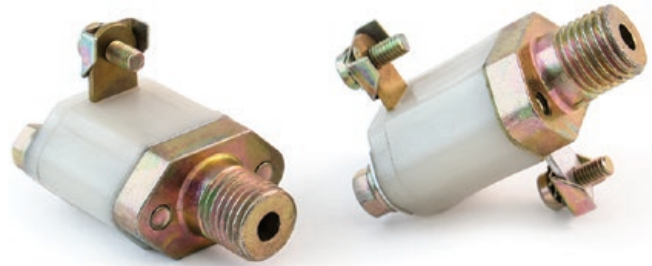

P/N	DESCRIPTION
401214	1/4" Single Terminal
401215	1/4" Double Terminal

PUSH/MOMENTARY SWITCHES



422711

P/N	DESCRIPTION	FUNCTION	TERMINALS
422711	Double Pole, Single Throw	Normally On	4 Screws
422712	Two Circuit	On/Mom - Off/On	4 Screws
422713	Four Circuit	On/Mom - Off/Mom - On	6 Screws
422714	Double Pole, Single Throw	Normally On	4 Blades

...AND SO MUCH MORE!

**FROM UNDER THE HOOD TO THE BACK OF THE TRAILER...
WE'VE GOT YOU COVERED.**

Over the years, Tramec Sloan has expanded our product offering outside of our 3 core areas as our customer needs have grown. Whether an OEM looking for us to manufacture a brass fuel cap for their production or a distributor looking for a MADE in the USA water pump, we have you covered.

Our commitment to deliver high quality at value is never compromised, ever. We appreciate the trust by our customers to provide them with an ever growing list of products and brand names.

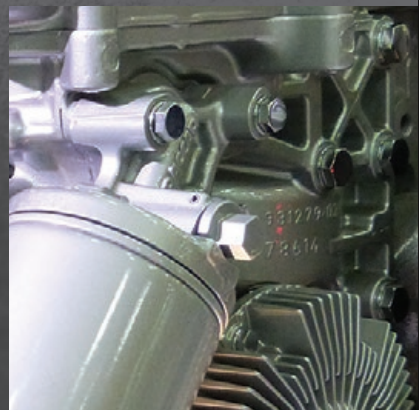



IN THIS SECTION:

PRODUCT	PAGE	PRODUCT	PAGE
MAXXValue Wiper Blades	286	Brass Fuel Caps.....	330
Michelin Wiper Blades.....	288	Aluminum Fuel Caps.....	332
Water Pumps.....	291	Wheel Nuts.....	334
Dipsticks	316	Hub Caps.....	336
Oil Caps.....	317	Document Holders	337
Engine Heaters	318	Tarp Straps	337
Hose Clamps.....	325	U-Bolt Kits.....	338
Diesel Anti-Siphon Devices	329	End Threaded Rod	339

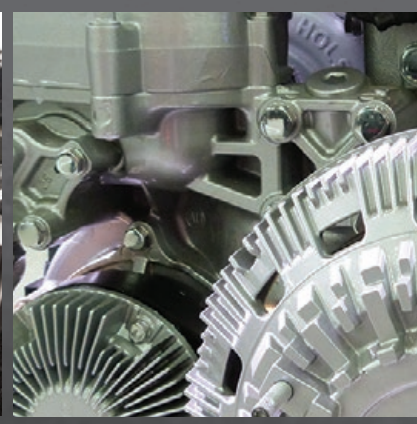

MAXXVALUE™ WIPER BLADES

Tramec Sloan's Own Line of Heavy Duty Wiper Blades

- Universal Connector to Fit All Hook, Pin, and Bayonet Arms
- Graphite Coated Rubber for Extra Life
- Polymer Joints for Quiet Operation
- Aerodynamic Frame to Prevent Wind-lift
- Attractive Retail Packaging
- Great for Heavy Duty Trucks, Recreational Vehicles, School & Transit Buses, Construction, Agriculture & More!

MAXXVALUE™ WIPER BLADE *Retail Blister Packs*

P/N	DESCRIPTION
MV31516	16" MAXXValue Wiper Blade
MV31517	17" MAXXValue Wiper Blade
MV31518	18" MAXXValue Wiper Blade
MV31519	19" MAXXValue Wiper Blade
MV31520	20" MAXXValue Wiper Blade
MV31522	22" MAXXValue Wiper Blade
MV31524	24" MAXXValue Wiper Blade

MAXXVALUE™ WIPER BLADE *Bulk Unpackaged, Std Pack of 10*

P/N	DESCRIPTION
MV31516B	16" MAXXValue Wiper Blade
MV31518B	18" MAXXValue Wiper Blade
MV31520B	20" MAXXValue Wiper Blade
MV31522B	22" MAXXValue Wiper Blade
MV31524B	24" MAXXValue Wiper Blade





MAXXVALUE™ WIPER BLADE FLOOR DISPLAY RACK

- Eye-Catching Retail Display
- Slim Profile Saves Floor Space
- Locking Wheels
- 20 Hooks Hold 5 Blades Each
- Fully Stocked with MAXXValue™ Wiper Blades:

16" Blades (x10)	20" Blades (x10)
17" Blades (x10)	22" Blades (x30)
18" Blades (x10)	24" Blades (x20)
19" Blades (x10)	

P/N	DESCRIPTION
9946	MAXXValue Wiper Floor Rack

MAXXVALUE™



WIPER BLADES

MICHELIN STEALTH® WIPER BLADES

- The Hybrid Design of the Stealth Blade Combines the Best of a Traditional & Beam Blade into One!
- All-Season Rated for Excellent Performance in Rain, Ice, and Snow
- Built Tough for Durable Wiping Performance
- Sleek Cover
- Natural Rubber Blade Eliminates Chattering and Delivers a Superior Wiping Performance
- Smart-Flex Design Fits Windshields Better for Superior Windshield Contact
- EZ Lok Connector
- Independent Suspension Adjusts to the Curve of Your Windshield for Optimal Windshield Contact All the Way to the Ends of the Wiper Blade



MICHELIN STEALTH® WIPER BLADES

Retail Blister Packs, Standard Pack of 5

P/N	DESCRIPTION
6716	16" Michelin Stealth Wiper Blade
6717	17" Michelin Stealth Wiper Blade
6718	18" Michelin Stealth Wiper Blade
6719	19" Michelin Stealth Wiper Blade
6720	20" Michelin Stealth Wiper Blade
6721	21" Michelin Stealth Wiper Blade
6722	22" Michelin Stealth Wiper Blade
6724	24" Michelin Stealth Wiper Blade
6726	26" Michelin Stealth Wiper Blade
6728	28" Michelin Stealth Wiper Blade



TRAMEC SLOAN IS YOUR EXCLUSIVE INDUSTRY SOURCE FOR MICHELIN HEAVY DUTY WIPER BLADES!



MICHELIN RAINFORCE™ WIPER BLADES

- Features a Heavy-Duty Frame with All-Metal Riveted Construction & Aero Vented Design
- The Aerodynamic Design & Durable Stainless Steel Flexors Help Hug the Glass in All Weather Conditions
- Compression-Molded, Graphite-Coated Natural Rubber Blade for an Improved Wipe Quality that's Smooth & Quiet
- Fast & Easy Pre-Installed Connector System

MICHELIN RAINFORCE™ WIPER BLADES

Retail Blister Packs, Standard Pack of 5

P/N	DESCRIPTION
6811	11" Michelin RainForce Wiper Blade
6812	12" Michelin RainForce Wiper Blade
6813	13" Michelin RainForce Wiper Blade
6814	14" Michelin RainForce Wiper Blade
6815	15" Michelin RainForce Wiper Blade
6816	16" Michelin RainForce Wiper Blade
6817	17" Michelin RainForce Wiper Blade
6818	18" Michelin RainForce Wiper Blade
6819	19" Michelin RainForce Wiper Blade
6820	20" Michelin RainForce Wiper Blade
6821	21" Michelin RainForce Wiper Blade
6822	22" Michelin RainForce Wiper Blade
6824	24" Michelin RainForce Wiper Blade
6826	26" Michelin RainForce Wiper Blade
6828	28" Michelin RainForce Wiper Blade

MICHELIN RAINFORCE™ WIPER BLADES

Bulk Unpackaged, Standard Pack of 10

P/N	DESCRIPTION
6811B	11" Michelin RainForce Wiper Blade
6812B	12" Michelin RainForce Wiper Blade
6813B	13" Michelin RainForce Wiper Blade
6814B	14" Michelin RainForce Wiper Blade
6815B	15" Michelin RainForce Wiper Blade
6816B	16" Michelin RainForce Wiper Blade
6817B	17" Michelin RainForce Wiper Blade
6818B	18" Michelin RainForce Wiper Blade
6819B	19" Michelin RainForce Wiper Blade
6820B	20" Michelin RainForce Wiper Blade
6821B	21" Michelin RainForce Wiper Blade
6822B	22" Michelin RainForce Wiper Blade
6824B	24" Michelin RainForce Wiper Blade
6826B	26" Michelin RainForce Wiper Blade
6828B	28" Michelin RainForce Wiper Blade



WIPER BLADES

MICHELIN HYDRO-EDGE™ SNOWBLADE™ WIPERS

Retail Blister Packs, Standard Pack of 5

- Durable Rubber Boot that Resists Exposure to Salt, Snow, Sleet, and Ice
- Inner Frame Parts are Made of Heavy-Duty 304 Stainless Steel
- Features a Compression-Molded Natural Rubber Wiping Element



P/N	DESCRIPTION
2616	16" Michelin Stealth Wiper Blade
2618	18" Michelin Stealth Wiper Blade
2620	20" Michelin Stealth Wiper Blade
2622	22" Michelin Stealth Wiper Blade
2624	24" Michelin Stealth Wiper Blade

FLAT WIPER BLADES

Bulk Unpackaged, Standard Pack of 10

- Designed for Flat Windshields Typically Found on Heavy Duty Trucks, School Buses, Step Vans, and Recreational Vehicles



P/N	DESCRIPTION
6811F	11" Flat Wiper Blade
6812F	12" Flat Wiper Blade
6813F	13" Flat Wiper Blade
6814F	14" Flat Wiper Blade
6815F	15" Flat Wiper Blade
6816F	16" Flat Wiper Blade
6817F	17" Flat Wiper Blade
6818F	18" Flat Wiper Blade
6819F	19" Flat Wiper Blade
6820F	20" Flat Wiper Blade
6821F	21" Flat Wiper Blade
6822F	22" Flat Wiper Blade

FLEX WIPER BLADES

Bulk Unpackaged, Standard Pack of 10

- Flex Blades are Designed for Wiper Arms that Have Less than 48oz of Load
- The Flex Blades May be Used with Both Flat and Curved Windshields



P/N	DESCRIPTION
6812FX	12" Flex Wiper Blade
6814FX	14" Flex Wiper Blade
6815FX	15" Flex Wiper Blade
6816FX	16" Flex Wiper Blade
6818FX	18" Flex Wiper Blade
6820FX	20" Flex Wiper Blade
6822FX	22" Flex Wiper Blade
6824FX	24" Flex Wiper Blade
6826FX	26" Flex Wiper Blade
6828FX	28" Flex Wiper Blade
6832FX	32" Flex Wiper Blade



WATER PUMPS

COVERAGE ACROSS ALL MAKES & MODELS!

As the heart of the engine's cooling system, water pumps are a vital part of overall engine health. With the implementation of more strict emission standards over the years, under hood engine temperatures will continue to increase. That's why it's more important than ever to have a reliable water pump you can count on.

Tramec Sloan's water pumps are brand new, 100% vacuum-leak tested, American made, and carry a 2-Year/200,000-Mile warranty.

- CASE
- DETROIT DIESEL
- MACK / VOLVO
- CATERPILLAR
- FORD
- MERCEDES
- CUMMINS
- GM / GMC
- NAVISTAR
- CHEVROLET
- INTERNATIONAL
- THERMO KING



MANUFACTURED
IN THE U.S.A.

CASE - 188D

- Includes Hub & Mounting Gasket
- Impeller Diameter: 3-1/8"
- OEM Pump #: A146584, A48363, A36979, A37758, G11939
- OEM Casting #: A37751



P/N	DESCRIPTION
6360	Case 188D

CATERPILLAR - 3208 ENGINE

- 10.4L (636 In³)
- Bolt-On Pulley (Not Provided)
- 4-1/4" Impeller
- OEM Pump #: 2W1225, 9N6147, OR0781
- OEM Casting #: 9N3076, 9L3076, 9N1249



P/N	DESCRIPTION
6001	CAT 3208 10.4L Bolt on Pulley (Not Provided)

CATERPILLAR - 3208 ENGINE

- 10.4L (636 In³)
- Bolt-On 3-Groove 5.62" Diameter Pulley (Provided)
- 4-1/4" Impeller
- OEM Pump #: 2W1225, 9N6147, OR0781
- OEM Casting #: 9N3076, 9L3076, 9N1249



P/N	DESCRIPTION
6002	CAT 3208 10.4L Bolt on 3 Groove Pulley

CATERPILLAR - 3208 ENGINE

- 10.4L (636 In³)
- Threaded Bolt-On Pulley for Fan Clutch
- 4-1/4" Impeller
- OEM Pump #: 2W1227
- OEM Casting #: 9N3076, 9L3076



P/N	DESCRIPTION
6004	CAT 3208 10.4L Threaded Bolt On Pulley

CATERPILLAR - 3406B/C ENGINE

- 14.6L (893 In³)
- Flat Gear, Not Interchangeable with the 3406 E 5-3/4" Impeller
- 74 Tooth Gear, 7-7/8" Diameter Flat Gear
- OEM Pump #: 1354926, 7W7019, 7C4957, OR8217
- OEM Casting #: 9N5034



P/N	DESCRIPTION
6006	CAT 3406B/C 14.6L Flat Gear

CATERPILLAR - BACKING PLATE FOR 3406B/C ENGINE

- Water Pump Backing Plate
- Fits Several 3406B Models: 1N2959, 2W3277, 9N5035, 1025939, 1341340, 1341341, 3520203, OR8217, and 10R0482
- OEM Pump #: 7C9222, 4PL2383



P/N	DESCRIPTION
6010	CAT 3406B/C 14.6L Backing Plate

CATERPILLAR - 3406E ENGINE

- Not Interchangeable with the 3406B/C
- 5-3/4" Impeller
- 74 Tooth, 7-7/8" Diameter Dished Gear with Helical Cut Teeth
- OEM Pump #: 6I3890, OR4120, OR8330, OR8218, 10R0483
- OEM Casting #: 100-7479, 135-4918



P/N	DESCRIPTION
6012	CAT 3406E

CATERPILLAR - 3306 ENGINE

- This Pump Differs from Other 3306 Models in that it Has a Bolt Holding the Gear in Place and Lacks a Spline Drive
- Gear has Angled Teeth
- OEM Pump #: 2W8001, OR9785, OR1002
- OEM Casting #: 1W4619, 7N196, 172-7827, 154-3945



P/N	DESCRIPTION
6013	CAT 3306

CATERPILLAR - 3116 ENGINE

- 3.75" Pulley
- Includes 2 O-Rings & 3 Pipe Plugs
- OEM Pump #: 4W7589



P/N	DESCRIPTION
6014	CAT 3116 3.75" Pulley

CATERPILLAR - 3406B/C/E ENGINE

- Same as the 6012, but with Straight Tooth on the Gear
- 5-3/4" Impeller
- 74 Tooth, 7-7/8" Diameter Dished Gear with Straight Teeth
- OEM Pump #: 6I3890, OR4120, OR8330, OR8218
- OEM Casting #: 161-5718, 153-9023 (Gear Number)



P/N	DESCRIPTION
6015	CAT 3406B/C/E Straight Tooth

CATERPILLAR - 3116/3126

- 3.75" Pulley
- Comes with Installed Plugs
- OEM Casting #: 4P3681 (Body), 7W3780 (Pulley)
- OEM Pump #: 1208402, 4P3682, OR1011, OR1013, 1593141, 4P3682, 2OR0586



P/N	DESCRIPTION
6016	CAT 3116 / 3126 3.75" Pulley Dual Spout

CATERPILLAR - 3116/3126

- 4.37" Pulley
- Comes with Installed Plugs
- OEM Pump #: 4P3683, 9Y5249, OR1015, OR3007, 9V4879
- OEM Casting #: 4P3681 (Body), 7C7890 (Pulley)



P/N	DESCRIPTION
6017	CAT 3116 / 3126 4.37" Pulley

CATERPILLAR - 3116/3126

- 3.75" Pulley
- This Pump has One Spout. The Casting May have an Additional Port in Place of the Missing Spout and May be Factory Plugged
- OEM Pump #: 1268277
- OEM Casting #: 285121



P/N	DESCRIPTION
6018	CAT 3116 / 3126 3.75" Pulley One Spout

CATERPILLAR - C15

- Bolt-On Dome Gear with Straight Teeth
- 5.9" Impeller Opening
- OEM Pump #: 1615719, 10R0484, OR9869
- OEM Casting #: 161-5718, 161-5719



P/N	DESCRIPTION
6019	CAT C15 Straight Teeth

CATERPILLAR - C12

- OEM Pump #: 1767000, 1006944, 1358053, 1766999



P/N	DESCRIPTION
6020	CAT C12

CATERPILLAR - C15/C18 ACERT

- OEM #: 2807374, 3145155, 3362213, 2243229, 10R8660



P/N	DESCRIPTION
6021	CAT C15 ACERT

CATERPILLAR - C9, 3126E

- OEM #: 352-2080, 10R5406, 227-4298, 200-1212 260-1546, 227-4300



P/N	DESCRIPTION
6022	CAT C9, 3126E

CATERPILLAR - C7, 3126B

- OEM #: 352-2109, 10R5407, 227-8843, 227-4299

P/N	DESCRIPTION
6023	CAT C7, 3126B



CUMMINS - SMALL CAM FFC

- 2-Groove Pulley
- 7-Hole Mount
- NTC-270-CT, NT855-C280, NTC-290-R, NT855-C310, NT-310, NTC-355, NT855-C335, NTC350, NTA855-C360, NTC290
- OEM Pump #: AR45090, 3801784, 3000886
- OEM Casting #: 219040, 210238
- No Vent
- 5.0" Impeller

P/N	DESCRIPTION
6051	Cummins Small Cam FFC 2 Groove Pulley



CUMMINS - BIG CAM

- Multi-Groove, 4-5/8" Diameter Pulley
- Vented
- 4-1/2" Impeller
- Includes 1 O-Ring, 2 Pipe Plugs and 2 Gaskets
- NTC290, NTC350, NTC400
- Formula 290, 350 - *Non-Vented
- 7-Hole Mount
- OEM Pump #: 3801788, 3022474, AR45184, 3036876
- OEM Casting #: 218274, 3045163

P/N	DESCRIPTION
6052	Cummins Big Cam



CUMMINS - PANCAKE

- 5-1/2" Bore
- Short Shaft with Pulley (Non-FFC)
- NH230, NH250, NHC270, NHE225 Diesel, NT280, NT300, NT310, NT335, NT380, NTA380, NTC280, NTC335, NTC350 Diesel
- OEM Pump #: AR4284, AR4283, BM78372, 4919813
- OEM Casting #: 196845

P/N	DESCRIPTION
6053	Cummins Pancake 5 1/2" Bore Short Shaft



CUMMINS - SMALL CAM FCC IDLER

- 4.0" Diameter 2-Groove Pulley
- OEM Pump #: 3064920, AR8851
- OEM Casting #: 208118



P/N	DESCRIPTION
6058	Cummins Small Cam FCC Idler 2 Groove Pulley

CUMMINS - BIG CAM IDLER

- 6-Groove Pulley
- OEM Pump #: 3064919, AR45189
- OEM Casting #: 215397



P/N	DESCRIPTION
6059	Cummins Big Cam Idler 6 Groove Pulley

CUMMINS - BIG CAM III

- 4-2/3" Multi-Groove Pulley
- 4" Impeller
- Vented
- NTC300, NTC350, and NTC400
- Formula 300, 350, 400, and 475
- OEM Pump #: 3004923
- OEM Casting #: 218274



P/N	DESCRIPTION
6061	Cummins Big Cam III

CUMMINS - BIG CAM IV, 855

- 4.275" Multi-Groove Pulley
- 4-1/2" Impeller
- 1/4" Vented Hole
- Applications: 300, 350, 400, Fleet 300, NTC-Formula 300, 350, 400, NTC-475
- OEM Pump #: 3801708, 3045943, 3049543, AR45217
- OEM Casting #: 3036877, 3045163



P/N	DESCRIPTION
6064	Cummins Big Cam IV

CUMMINS - LTA 10 SERIES

- Engines Before 1991
- 4-Hole Mount
- 4.090" Impeller
- Covered Gear
- Applications: LTA10-240, 270, and 300 Engines
- OEM Pump #: 3803402, 3801840
- OEM Casting #: 3039182, 3035157



P/N	DESCRIPTION
6068	Cummins LTA 10 Series

CUMMINS - 88 BIG CAM IV

- 4.275" Multi-Groove Pulley
- 4-1/2" Impeller
- NTC-300, 315, 350, 365, 400
- OEM Pump #: 3803138, 3803030
- OEM Casting #: 3062899, 3053538



P/N	DESCRIPTION
6069	Cummins 88 Big Cam IV

CUMMINS - 88 BIG CAM IV IDLER

- Smooth Pulley
- OEM Pump #: 3065000



P/N	DESCRIPTION
6070	Cummins 88 Big Cam IV Idler Smooth Pulley

CUMMINS - 88 BIG CAM IV IDLER

- 4-Groove Pulley
- OEM Pump #: 3081234, 3062931, 3064201
- OEM Casting #: 3064201, 3062693, 3064201R



P/N	DESCRIPTION
6071	Cummins 88 Big Cam IV Idler 4 Groove Pulley

CUMMINS - N14

- 4.275" Multi-Groove Pulley
- 4-1/2" Impeller
- Modified Suitcase Style
- 6-Bolt Mounting
- OEM Pump #: 3803605, 3803361
- OEM Casting #: 3069644, 3076523

P/N	DESCRIPTION
6073	Cummins N14



CUMMINS - N14 IDLER

- Multi-Groove Pulley (6 Grooves)
- Press-On Bearing Cover
- OEM Pump #: 3066330
- OEM Casting #: 3072355

P/N	DESCRIPTION
6074	Cummins N14 Idler 6 Groove Pulley



CUMMINS - B SERIES

- 4 Cylinder (3.9L) & 6 Cylinder (5.9L)
- 2-Hole Mount
- OEM Pump #: 3286277, 3802358, 3802004, 3913432, R4723690, 3903749, 3802790, F3AZ-8501ARM (Ford Application)
- OEM Casting #: 3913132, 3913432, 3920310, 3928395, 3903357
- 5 Vane Stamped Impeller
- Hardened Pulley - No Belt Lip

P/N	DESCRIPTION
6075	Cummins B Series Hardened Pulley No Belt Lip



CUMMINS - L10-E SERIES

- 10L (64 Cu. In.)
- Engines: 1991 & After
- 3-Hole Mount
- 4.09" Impeller
- Exposed Gear
- Longer Shaft than 3800745RX, L10-310E, L10-330E, and M11 Series
- OEM Pump #: 3803403, 4955705, 4003929, 3800737, 3803403RX
- OEM Casting #: 3882615

P/N	DESCRIPTION
6076	Cummins L10-E 10L



CUMMINS - C SERIES, 8.3L

- Hardened Pulley with Belt Lip, Short Nose
- 4-1/3" Flat-Pulley
- OEM Pump #: 3804883, 3806180, 3802081, 3905357, 3913430, F3HZ-8501B (Ford Application)
- OEM Casting #: 3903357, 3913430, 3802051, 3913439



P/N	DESCRIPTION
6077	Cummins C Series 8.3L Short Nose Hardened Pulley with Belt Lip

CUMMINS - L-10 SERIES IDLER

- Engines Before 1991
- Fan Drive Idler Assembly
- 3.9" Multi-Groove Pulley (8 Grooves)
- Press-On Bearing Cover
- OEM Pump #: 3062602
- OEM Casting #: 3060884, 3064201R, 3062602



P/N	DESCRIPTION
6078	Cummins L10 Series Idler 8 Groove Pulley

CUMMINS - ISB

- 3.47" Diameter Hardened Pulley
- 3.095" Diameter Stamped Impeller
- OEM Pump #: 3286278, R4723690, 3285410, 3285414
- OEM Casting #: 3920310



P/N	DESCRIPTION
6081	Cummins ISB Hardened Pulley

CUMMINS - ISC

- 4.33" Diameter Long Nose/ Hardened Pulley
- 8.3L
- OEM Pump #: 3286293, 4089647, 3973114
- OEM Casting #: 2370-10C



P/N	DESCRIPTION
6082	Cummins ISC 8.3L Long Nose Hardened Pulley

CUMMINS - DINA

- 6-Cylinder, 8-Cylinder
- V-6 (155 Cu. In.) Engines
- V-8 (210 Cu. In.) Engines
- OEM Pump #: AR61788, A34079A05, 4919812
- OEM Casting #: 555260



P/N	DESCRIPTION
6083	Cummins DINA

CUMMINS - C ENCORE

- Water Pump Kit - Hard
- OEM Pump #: 4089647



P/N	DESCRIPTION
6084	Cummins C Encore

CUMMINS - ISC & ISL

- ISC (8.3L) & ISL (8.9L)
- Dome Pulley
- OEM Pump #: 3804927, 3940052, 4089647(NX)
- OEM Casting #: 2370-10L, 2369-10, 1926-10



P/N	DESCRIPTION
6086	Cummins ISC / ISL Dome Pulley

CUMMINS - ISX 10GR

- 15.0L (912 Cu. In.)
- Equipped with 10-Ribbed Serpentine Belt Pulley
- OEM Pump #: 4089908



P/N	DESCRIPTION
6088	Cummins ISX 10GR 15.0L 10 Ribbed Pulley

CUMMINS - ISX 12GR

- 15.0L (912 Cu. In.)
- Equipped with 12-Ribbed Serpentine Belt Pulley
- OEM Pump #: 4089910



P/N	DESCRIPTION
6089	Cummins ISX 12GR 15.0L 12 Ribbed Pulley

CUMMINS - L10 & M11 E SERIES

- Short Shaft
- 3-Hole Mount
- OEM Pump #: 4955706, 3800745, 3800479, 4003929, 3401009, 2882145, 4955708

P/N	DESCRIPTION
6090	Cummins L10 / M11 E Series 3 Hole Mount Short Shaft



CUMMINS - C SERIES LONG NOSE

- Dome Style Nose
- Hardened Pulley
- OEM Pump #: 3800974, 3926912, 3923568, 3285323, 3800976

P/N	DESCRIPTION
6091	Cummins C Series Long Nose Dome Style



CUMMINS - B SERIES, NEW STYLE

- Open Faced, 5 Vane Stamped Impeller
- 2-Hole Mount
- OEM Pump #: 3286275

P/N	DESCRIPTION
6092	Cummins B Series New Style 5 Vane Impeller



CUMMINS - ISB SERIES

- 5.9L & 6.7L
- 3.25" Diameter Cast 7 Vane Impeller
- 3.46" Diameter Pulley
- OEM Pump #: 3800984, 4891252, 24955394, 2881804

P/N	DESCRIPTION
6093	Cummins ISB Series



CUMMINS - ISX & ISZ

- 12-Groove Pulley, Pump Only
- OEM #: 3684450 & 3683651

P/N	DESCRIPTION
6094	Cummins ISX & ISZ, 12-Groove Pulley, Pump Only



CUMMINS - ISM M11

- For Engine Models: ISM CM875, QSM11 CM570, ISM CM570, and M11 MECHANICAL, ISM CM876, ISM CM570/870
- CELECT PLUS, ISM CM876 E, M11 CELECT, ISM11 CM876 SN, - OEM #: 4955708

P/N	DESCRIPTION
6095	Cummins ISM M11



CUMMINS - ISX/QSX

- OEM #: 4089909

P/N	DESCRIPTION
6096	Cummins ISX/QSX



CUMMINS - ISM/QSM

- OEM #: 4955709, 4089455 & 4972851

P/N	DESCRIPTION
6097	Cummins ISM/QSM



DETROIT DIESEL - 53 SERIES

- Left Hand - 2-Belt Pulley
- OEM Pump #: 23506003, 5144685, 5109551
- OEM Casting #: 5144688, 5119280

P/N	DESCRIPTION
6101	Detroit Diesel 53 Series Left Hand



DETROIT DIESEL - 53 SERIES

- Right Hand - 2-Belt Pulley
- OEM Pump #: 23506007, 5144686, 5178658, 5144687, 5109046
- OEM Casting #: 5144689, 5178318, 5119281, 5144889

P/N	DESCRIPTION
6102	Detroit Diesel 53 Series Right Hand



DETROIT DIESEL - 71 SERIES IN-LINE

- Left Hand - Standard Capacity
- OEM Pump #: 23506723, 5149706, 5150439, 5159059, 5186575, 5135595
- OEM Casting #: 5135601, 5186573, 8920924, 5178317

P/N	DESCRIPTION
6103	Detroit Diesel 71 Series In-Line Left Hand Standard Capacity



DETROIT DIESEL - 71 SERIES IN-LINE

- Right Hand - Standard Capacity
- OEM Pump #: 23506735, 5149707, 5135596, 5186576, 5159060
- OEM Casting #: 5135602, 5186574, 8920925, 517318

P/N	DESCRIPTION
6104	Detroit Diesel 71 Series In-Line Right Hand Standard Capacity



DETROIT DIESEL - 71 SERIES IN-LINE

- Left Hand - High Capacity
- OEM Pump #: 23506704, 5149710, 8920915, 23506204
- OEM Casting #: 5182069, 8920915, 8920917

P/N	DESCRIPTION
6113	Detroit Diesel 71 Series In-Line Left Hand High Capacity



DETROIT DIESEL - 71 SERIES IN-LINE

- Right Hand - High Capacity
- OEM Pump #: 23506711, 5149708, 8920916
- OEM Casting #: 5135611, 5182070, 8920916, 8920918

P/N	DESCRIPTION
6114	Detroit Diesel 71 Series In-Line Right Hand High Capacity



DETROIT DIESEL - 8.2L LATE STYLE

- With Heater Bypass
- No Pulley
- OEM Pump #: 8928672, 8927158
- OEM Casting #: 8924657, 8828804, and 8926904
- Aftermarket Casting #: 40-181



P/N	DESCRIPTION
6119	Detroit Diesel 8.2L Late Style with Heater Bypass (No Pulley)

DETROIT DIESEL - 50/60 SERIES

- After 12/90
- 61-Tooth Gear
- Rear Mount
- OEM Pump #: 23505895, 23505895, 23520136, R3518216, 23522707
- OEM Casting #: 23505894, 23517027
- Premium Seal
- Metal Back Plate/Seal
- Gear Driven
- Standard Flow Capacity
- 7-Vane Impeller



P/N	DESCRIPTION
6122	Detroit Diesel 50 / 60 Series 7 Vane Impeller

DETROIT DIESEL - 50/60 SERIES

- After 12/90
- High Capacity with Reservoir/Pouch
- Second Series
- Gear Driven with 2 Outlets
- High Horsepower (470 & Up)
- 3/8" Pipe Ports
- 6-Vane Impeller
- OEM Pump #: 23522721, 23526039, 23517025, 23518215, 23522707, 23539602
- OEM Casting #: 23517027, 23522721



P/N	DESCRIPTION
6131	Detroit Diesel 50 / 60 Series Pocket Style 6 Vane Impeller

DETROIT DIESEL - 60 SERIES EGR

- EGR = Exhaust Gas Recirculation
- OEM Pump #: 23532542, 23535017, 23531257
- OEM Casting #: 23530427
- 12.7L Water Pump



P/N	DESCRIPTION
6132	Detroit Diesel Series 60 EGR 12.7L

DETROIT DIESEL - 60 SERIES EGR

- EGR = Exhaust Gas Recirculation - 14.0L Water Pump
- OEM Pump #: 23532543, 23535018, 23531258, R23538636
- OEM Casting #: 23530429



P/N	DESCRIPTION
6133	Detroit Diesel Series 60 EGR 14.0L

DETROIT DIESEL - DD13/DD15

- OEM #: EA 472 200 04 01



P/N	DESCRIPTION
6134	Detroit Diesel DD13 / DD15

DETROIT DIESEL - 60 SERIES EGR

- EGR = Exhaust Gas Recirculation - Small Gear, 49 Teeth
- 14.0L Water Pump - OEM #: 23538636



P/N	DESCRIPTION
6135	Detroit Diesel 60 Series 14.0L EGR Small Gear

FORD - 6.0 DIESEL POWERSTROKE 2003-2005

- OEM Pump #: 3C3Z8501, PW480, 3C3Z-8501-BA, 3C3Z-8501-ABRM



P/N	DESCRIPTION
6125	Ford 6.0 Powerstroke 2003-2005

FORD - 6.0 DIESEL POWERSTROKE 2005-2010

- OEM Pump #: 4C3Z8501AC, PW491, 4C3Z-8501-AB, 4C3Z-8501-ABRM, F81Z8501-ABRM



P/N	DESCRIPTION
6126	Ford 6.0 Powerstroke 2005-2010

FORD - 6.0 DIESEL POWERSTROKE 2004-2006

- OEM Pump #: 18-1784, 4C3Z-8501ABRM, F8128501ABRM



P/N	DESCRIPTION
6128	Ford 6.0 Powerstroke 2004-2006

FORD - 6.0 DIESEL POWERSTROKE 2003

- OEM Pump #: 18-1785, 3C3Z-8501ABRM



P/N	DESCRIPTION
6129	Ford 6.0 Powerstroke 2003

FORD - 6.0 DIESEL POWERSTROKE 2003-2006 HEAVY DUTY

- OEM Pump #: 18-1786



P/N	DESCRIPTION
6130	Ford 6.0 Powerstroke 2003-2006 Heavy Duty

FORD - 6.9/7.3 LITER DIESEL

- 1983-94 (Non-Power Stroke) - Threaded Hub
- Belt Driven - OEM Pump #: E4TZ-8501C, E4TZ-8501B
- 4-1/2" Hub Outside Diameter - OEM Casting #: 446430C1, 446430C2, 446430C3, 446430C4
- Pulley Not Supplied



P/N	DESCRIPTION
6304	Ford 6.9 L / 7.3L 1983-1994 Non Powerstroke

FORD - 6.9/7.3 LITER DIESEL

- 1983-94 (non Power Stroke), - OEM Pump #: F1HZ-8501CRM
- 1991-93, 1994 F600 Only without - OEM Casting #: F0HN8505AA, F0HZ-8508-AA
- Pump Mounted Fan



P/N	DESCRIPTION
6309	Ford 6.9L / 7.3L 1983-1994 Non Powerstroke

WATER PUMPS

FORD - 7.3 LITER TURBO DIESEL, 94-95 DIRECT INJECTION

- OEM Pump #: F4TZ-8501ARM, F5TZ-8501BRM, F5TZ-8501B, F5TZ-8501C
- OEM Casting #: 1822823C1, 1823611C2



P/N	DESCRIPTION
6310	Ford 7.3L 1994-1995

FORD - 7.3 LITER TURBO DIESEL, 96-02 DIRECT INJECTION

- Application: 2000-2002 E150/E350, 2000-2002 Excursion, 1996-2002 F250, F350, F450, F550 Super Duty, 1996-1997 F53/59 Stripped Chassis
- OEM Pump #: F6TZ-8501AA, F7TZ-8501BRM, F81Z-8501ARM,
- OEM Casting #: 1831005C2
- F81Z-8501A, F81Z-8501B, F81Z-8501CRM, F81Z-8501FA, F7TZ-8501B, F7TZ-8501C, F6TZ-8505ARM, F6TZ-8505BRM



P/N	DESCRIPTION
6311	Ford 7.3L 1996-2002

FORD - 6.6/7.8 LITER

- 401 & 476 Diesel
- 1987-1991
- OEM Pump #: E8HZ8501B, E7HZ8501A, E9TZ8501B
- OEM Casting #: E7HN8508AA, E6HN8508AA, E7HN8508AA
- Auxiliary Mount
- 3/4" Outlet
- Cab Over



P/N	DESCRIPTION
6314	Ford 6.6/7.8L

GM - 6.2/6.5 LITER DIESEL

- 1982-96, 1986-90 Chevy & GMC
- Belt Driven
- Conventional Cab
- OEM Casting #: 14024206
- OEM Pump #: 12514269, 15633465, 15633466, 12633466, 14082745, 23500133, 14061698



P/N	DESCRIPTION
6117	GM 6.2/6.5L 1982-1996 Belt Driven (Pulley Not Supplied)

GM - 6.6 LITER DURAMAX, 2001-2004

- OEM Pump #: 97216136, 19113733, 252723, 251674, 252383



P/N	DESCRIPTION
6123	GM 6.6L Duramax 2001-2004

GM - 6.5 LITER DIESEL

- 1996-1999
- OEM Pump #: 12530176, 19168610, 88894036, 251-590, 5744662, 12534772
- OEM Casting #: 12553486, 12557071



P/N	DESCRIPTION
6124	GM 6.5L 1996-1999

GM - CHEVROLET DURAMAX 6.6L DIESEL

- 2001 - 2006
- OEM Pump #: 97372515, 98031233



P/N	DESCRIPTION
6127	GM 6.6L Duramax 2001-2006

MERCEDES BENZ - OM366, OM366A, OM366LA

- OEM Pump #: 366-200-5901, 366-200-0901, 366-200-0401, 366-200-4601, 355-200-5901



P/N	DESCRIPTION
6355	Mercedes Benz OM366 / OM366A / OM366LA

MERCEDES BENZ - OM366LA EURO II

- OEM Pump #: 366-200-6001, 366-200-1501



P/N	DESCRIPTION
6356	Mercedes Benz OM366LA Euro II

MERCEDES BENZ - OM364, OM364A

- 112 x 15mm Impeller
- OEM Pump #: 364-200-2001, 364-200-0101, 364-200-0901



P/N	DESCRIPTION
6357	Mercedes Benz OM364 / OM364A

MERCEDES BENZ - OM904

- 112 x 15mm Impeller
- OEM Pump #: 904-200-0401, 904-200-0801, 904-200-2601, 904-200-5101, 904-200-2001, 904-200-4901, 904-200-2661, 904-200-0601



P/N	DESCRIPTION
6358	Mercedes Benz OM904

MERCEDES BENZ - SPRINTER VAN, L5, 2.7L

- For 2500, 3500 2.7L Diesel - 2004-2007
- OEM Pump #: A6472000101, A642-200-1301, 5138057AA, 647-2000-0101



P/N	DESCRIPTION
6359	Mercedes Benz Sprinter Van L5 2.7L 2004-2007

NAVISTAR - DT466 ENGINE

- Conventional Cab Models - 1.12" Hex Nut x 6" Thick Right Hand Thread
- Belt Driven - Pulley Not Supplied
- 1.54" Thick Hub
- OEM Pump #: 685155C94, 685155C92
- OEM Casting #: 677856C1, 677856C2



P/N	DESCRIPTION
6301	Navistar DT466 Belt Driven Conventional Cab (Pulley Not Supplied)

NAVISTAR - DT466 ENGINE

- Cab Over Engine Models - OEM Pump #: 680899C92
- Belt Driven - OEM Casting #: 677137C1
- Pulley Not Supplied



P/N	DESCRIPTION
6302	Navistar DT466 Belt Driven Cab Over (Pulley Not Supplied)

NAVISTAR - 6.9/7.3 LITER DIESEL

- MV-404 and 446 Gas Engine - 2-5/8" Hub O.D.
- Belt Driven - Pulley Not Supplied
- OEM Pump #: 1809374C91, E4T2-8501C, 1805951C91, 1805952C91
- OEM Casting #: 446430C1, 446430C2, 446430C3



P/N	DESCRIPTION
6305	Navistar 6.9L / 7.3L MV-404/446 Gas Engine (Pulley Not Supplied)

NAVISTAR - 9.0 LITER ENGINE

- 1976-83 Cargostar, S Series with 9.0L Diesel Engine,
- Belt Driven
- Press On Hub
- OEM Pump #: 1700594C91, 1700594C92
- OEM Casting #: 489173C1



P/N	DESCRIPTION
6306	Navistar 9.0L 1976-1983

NAVISTAR - DTA360 ENGINE

- 5.9L (360 Cu. In.)
- Left Hand Thread with Bolt-On 1" Thick Hub
- Belt Driven
- Pulley Not Supplied
- OEM Pump #: 1815538C91, ZGA735327, 735445C91
- OEM Casting #: 677856C3



P/N	DESCRIPTION
6307	Navistar DTA 360 5.9L Left Hand Thread (Pulley Not Supplied)

NAVISTAR - 7.6L 466, 8.6L 530, 6.7L 408

- 1994-97
- Various Applications with 6-Cylinder DT360/466 New Generation Diesel Engines
- Stamped Steel Impeller
- OEM Pump #: 1817687C92, 1817687C94, 1817687C95, 1817687C96
- OEM Casting #: 1821935C91, 1821935C1, 1821935C3



P/N	DESCRIPTION
6313	Navistar 6.7L / 7.6L / 8.6L DT408 / DT466 / DT530 1994-1997

NAVISTAR - DT444E & T444E 7.3L

- 1994-2004
- Right Hand
- OEM Pump #: 1831676C92, 1823669C92, 1831676C31, YC3Z-8501AARM, YC3Z8501CA, 183167691
- OEM Casting #: 1822851C1, 1823669C92
- Direct Injection
- Screw-In Filter



P/N	DESCRIPTION
6315	Navistar 7.3L DT444E / T444E 1994-2004

WATER PUMPS

NAVISTAR - T444E 7.3L

- OEM #: 1823669C92

P/N	DESCRIPTION
6316	Navistar 7.3L T444E



NAVISTAR - DT444E & T444E 7.3L

- 2003 - 2007
- 5-Bolt Pump
- Bolt-On Pulley
- OEM Pump #: 1842664C92, 1842665C93
- OEM Casting #: 1841765C1

P/N	DESCRIPTION
6317	Navistar 7.6L DT466 / 530E 2003-2007 5 Bolt



NAVISTAR - MAXXFORCE 7.6, 4L

- OEM #: 1832498C91, 7081213C92

P/N	DESCRIPTION
6319	Navistar MaxxForce 7.6, 4L



NAVISTAR - MAXXFORCE DT9 & DT10

- OEM #: 1889116C92

P/N	DESCRIPTION
6320	Navistar MaxxForce DT9 & DT10



THERMOKING - ISUZU C201

- Refrigeration Units
- 207CC Diesel Engine
- OEM Pump #: 11-4576, 977696
- OEM Casting #: BTK, PH374

P/N	DESCRIPTION
6350	Thermo King Isuzu C201



THERMO KING - ISUZU

- Refrigeration Units
- 2.2 Liter Direct-Injection
- Threaded Auxiliary Port
- OEM Pump #: 11-5858
- OEM Casting #: M1, M2, M3



P/N	DESCRIPTION
6352	Thermo King Isuzu 2.2L Direct Injection Threated Auxiliary Port

THERMO KING - 2.2L ISUZU

- Refrigeration Units
- OEM Pump #: 11-5252, 11-9356



P/N	DESCRIPTION
6361	Thermo King 2.2L Isuzu

THERMO KING - YANMAR 482/486

- Refrigeration Units
- OEM Pump #: 18-1910



P/N	DESCRIPTION
6362	Thermo King Yanmar 482 / 486

VOLVO/MACK - MAXIDYNE

- 1.57" Long Shaft
- Mack End 675, 676 Engines
- OEM Pump #: 316GB443, 316GC1184, 316GC1211A, 316GC1211B
- OEM Casting #: 360GB443, 360GB343
- No Pulley
- Iron Impeller



P/N	DESCRIPTION
6205	Volvo/Mack END-T 675 / 676 Maxidyne

VOLVO/MACK - CHARGED AIR ECONODYNE

- .94" Long Shaft
- Mack E6, EM6 & EMS-6 Engines
- No Pulley
- OEM Pump #: 316GC1210A
- OEM Casting #: 360GB443



P/N	DESCRIPTION
6208	Volvo/Mack E6 / EM6 / EMS-6 .94" Shaft (No Pulley)

VOLVO/MACK - CHARGED AIR ECONODYNE

- 6-5/8" Diameter 3-Groove Pulley (Included)
- Mack E6, EM6 & EMS-6 Engine
- OEM Pump #: 316GC1210AX, 316GC1210A
- OEM Casting #: 360GB443

P/N	DESCRIPTION
6217	Volvo/Mack E6 / EM6 / EMS-6 3 Groove Pulley



VOLVO/MACK - ASET WITH 5.3" PULLEY

- OEM Pump #: 315GC3193
- OEM Casting #: 2739-17

P/N	DESCRIPTION
6219	Volvo/Mack ASET 5.3" Pulley



VOLVO/MACK - ASET WITH 5.9" PULLEY

- OEM Pump #: 315GC3196
- OEM Casting #: 2738-17

P/N	DESCRIPTION
6220	Volvo/Mack ASET 5.9" Pulley



VOLVO/MACK - D11, D13, D15

- OEM #: 85142304, 85124621

P/N	DESCRIPTION
6221	Volvo/Mack D11, D13, D15



VOLVO/MACK - E7 E-TECH WITHOUT PULLEY

- OEM #: 316GC284BX, 316GC3194

P/N	DESCRIPTION
6222	Volvo/Mack E7 E-Tech without Pulley



WATER PUMP TROUBLESHOOTING:

Water Pump Bearing & Shaft Failures are Predominately Caused by One or More of the Following Circumstances:

SHAFT AND FAN ARE OUT OF SQUARE:

It is extremely important that the fan is mounted square to the center line of the shaft. If it is not square, the fan will wobble, causing vibrations to develop. This is particularly important where shaft spacers are used to move the fan closer to the radiator. The mounting bolts, if not properly torqued, will cause the fan to be tilted and may result in permanent deformation of the spacer.

DEFECTIVE FAN UNIT:

Relatively minor fan defects can magnify strain on the water pump shaft at 3000 to 5000 RPM. A small piece of missing fan blade can result in tremendous undesirable centrifugal force. Fatigue cracks near the rivets can cause blade shift or vibration. Bent fan blades can cause severe load problems.

FATIGUED PULLEYS:

Damaging vibration can result from bent or cracked pulleys. This usually occurs when a pulley is improperly handled or installed.

OVERTIGHTENING OF FAN BELT:

An overtightened fan belt can overload the bearing, resulting in shorter than ordinary fatigue life. It also causes bending of the shaft. Sudden acceleration cause large unbalanced loads, excessive shaft bending and early shaft failure.

EXCESSIVE ACCELERATION:

Rapid engine acceleration, particularly in low gear during quick get-aways, place heavy overloads in the bearing. Any minor imbalance can be amplified during rapid acceleration and high speeds, which can result in severe whipping action and sudden fractures.

SHAFT FAILURE:

Examination of a failed water pump shaft will reveal the possible cause of failure. Discoloration around the fracture indicates high temperatures most likely caused by centrifugal forces due to shaft imbalance. A small amount of imbalance can result in tremendous strain on the shaft at operating RPM's. The overload is focused at one section of the shaft and ultimately the shaft will snap. Lack of discoloration at the break indicates minimal heat build up occurred before a catastrophic vibratory overload of the shaft causes a clean fracture. Rapid acceleration of the engine combined with imbalance in the shaft is the cause. Small vibrations are amplified during rapid acceleration and combined with other engine vibrations can result in a shaft fracture.

UNIVERSAL ADJUSTABLE OIL DIPSTICKS

- Fits Most Makes and Models
- Spring Steel Blade
- Easy to use: Simply Cut to Proper Length, Insert in Engine Filled with Oil, and then Mark

P/N	SIZE	BLADE SIZE
431116	31/32" x 48"	.032"x.25"
431117	31/32" x 48"	.020"x.187"
431118	31/32" x 84"	.032"x.25"
431119	31/32" x 84"	.020"x.187"
431120	1-1/32" x 48"	.032"x.25"
431121	1-1/32" x 84"	.032"x.25"



CANE HANDLE DIPSTICKS

- Pre-Phosphate Coated Spring Steel Blade
- 60" Blade Length
- .035" x .187" Blade Size

P/N	HANDLE	COLOR
431130	Cane Handle	Yellow
431131	Cane Handle	Black



T-STYLE HANDLE DIPSTICKS

- Pre-Phosphate Coated Spring Steel Blade
- 60" Blade Length
- .035" x .187" Blade Size

P/N	HANDLE	COLOR
431132	T-Style Handle	Yellow
431133	T-Style Handle	Black



ADJUSTABLE FILLER CAPS

- Creates a Positive Seal that Cannot be Bounced or Jarred Loose
- Tight Seal Virtually Locks Out Dirt, Rust and Other Engine Damaging Matter
- Available in a Variety of Standard Sizes
- Special Optional Features Include Chain, Plastic Low Clearance Handles, and Shrouded Caps

HOW IT WORKS

As the handle is turned clockwise, the bottom plate moves upward. This action causes the grooved rubber body to expand, completing a firm, positive, airtight seal. Release with a simple, counter-clockwise turn of the handle.

ADJUSTABLE FILLER CAPS

Standard Design

P/N	FILLER I.D.
431093	1"
431096	1-1/4"
431099	1-3/8"
431094	1-1/2"
431101	1-5/8"
431098	1-3/4"
431103	2"
431107	2-1/4"
431106	2-1/2"
431137	3"
431136	4-1/4"

ADJUSTABLE FILLER CAPS

With Special Features

P/N	FILLER I.D.	FEATURE
431100	1-3/8"	Protective Shroud
431095	1-1/2"	5" Chain
431102	1-7/8"	5" Chain
431104	2"	5" Chain
431105	2"	Low-Profile Plastic Knob
431108	2-3/8"	5" Chain
431135	3"	10" Chain
431134	3-7/8"	10" Chain



ENGINE HEATERS

HOTSTART® IN-BLOCK ENGINE HEATERS

In-block heaters mount directly into the water jacket of the engine. These direct immersion block heaters reduce engine wear due to cold starts by up to 50%. Warming the engine to the proper temperature also reduces idling and cranking time which saves fuel and increases battery life.

All engine heaters come with a 6ft grounded power cord.



CATERPILLAR C11, C13 ACERT ENGINE HEATER

P/N	DESCRIPTION
2905	1500W, 1-5/16" STOR Engine Heater



CATERPILLAR C15 ACERT ENGINE HEATER

P/N	DESCRIPTION
2907	1500W, 1-3/16" STOR Engine Heater



CATERPILLAR 3406E ENGINE HEATER

P/N	DESCRIPTION
2908	1500W, 1" NPT Engine Heater



CATERPILLAR & DETROIT DIESEL ENGINE HEATER

- Cat C9, 15, and 16 (Non-Acert) - Detroit Diesel 60 Series (Pre-2007)

P/N	DESCRIPTION
2915	1500W, 1" NPT Engine Heater
2937	1500W, 1" NPT Engine Heater with 11' Cord



CATERPILLAR C10, C12 ENGINE HEATER

P/N	DESCRIPTION
2917	1250W, 1" NPT Engine Heater



CATERPILLAR ENGINE HEATER

- Cat 3304, 3306, 3176 10.3L

P/N	DESCRIPTION
2918	1500W, 3/4" NPT Engine Heater



CATERPILLAR ENGINE HEATER

- Cat C7 Acert, Engine Model 3114, 3116, 3126

P/N	DESCRIPTION
2920	1500W, 44 MM FP Engine Heater
2932	1000W, 44 MM FP Engine Heater



CATERPILLAR & DETROIT DIESEL ENGINE HEATER

- Cat 3406C, 3406E, and 3408 - Detroit Diesel 50/60 Series (Pre '07)

P/N	DESCRIPTION
2944	1000W, 1" NPT Engine Heater



CATERPILLAR ENGINE HEATER

- Cat 3304, 3306, 3176

P/N	DESCRIPTION
2945	1250W, 3/4" NPT Engine Heater



CATERPILLAR 3208 ENGINE HEATER

P/N	DESCRIPTION
2954	1500W Engine Heater with 1" Plug



CUMMINS N14 (855) ENGINE HEATER

P/N	DESCRIPTION
2902	1500W Engine Heater with Flat Plate for 1/2" NPT Opening
2904	1500W Engine Heater with Flat Plate Design
2911	1500W Engine Heater with Flat Plate Design and Rotating Elbow



ENGINE HEATERS

CUMMINS ENGINE HEATER

- Cummins ISX, Signature 600 & QSX - 120 Volt

P/N	DESCRIPTION
2903	1500W Engine Heater with Plate



CUMMINS 6CT 8.3L ENGINE HEATER

P/N	DESCRIPTION
2906	1500W, FP Engine Heater



CUMMINS ISM 11L ENGINE HEATER

P/N	DESCRIPTION
2909	1500W Engine Heater with Plate



CUMMINS BT6 5.9L ENGINE HEATER

P/N	DESCRIPTION
2912	1000W, FP Engine Heater



CUMMINS ISB 5.9L ENGINE HEATER

P/N	DESCRIPTION
2913	750W, 3/4" NPT Engine Heater



CUMMINS & MACK ENGINE HEATER

- Cummins ISC & ISL - Mack E9, ENDT 865, and ENDT 866

P/N	DESCRIPTION
2916	1000W, 3/4" NPT Engine Heater



CUMMINS ISM, L10 ENGINE HEATER

P/N	DESCRIPTION
2919	1500W, 38 MM Engine Heater



CUMMINS 6BT 5.9L ENGINE HEATER

P/N	DESCRIPTION
2929	750W, FP Engine Heater



CUMMINS L10, M11 ISM ENGINE HEATER

- Inserts in the Forward Opening of the Heater Casting on the Right Rear Block
- Oil Heater Thread Size 1" NPT

P/N	DESCRIPTION
2956	240V, 1500W Engine Heater



DETROIT DIESEL ENGINE HEATER

- Detroit Diesel 6V-71, 8V-71, 6V-92 & 8V-92 (Except GMC General Models)

P/N	DESCRIPTION
2951	120V, 1500W Engine Heater



MACK E7 ENGINE HEATER

P/N	DESCRIPTION
2910	1500W Engine Heater with Plate



MACK ENGINE HEATER

- Mack Mid-Liner E3 MS200 & MS250
- Mounts in Rear Face of Block

P/N	DESCRIPTION
2947	120V, 1000W Engine Heater



ENGINE HEATERS

MASSEY FERGUSON ENGINE HEATER

- 3, 4, and 6-Cylinder
- Mounts in any of the 1-1/4" Freeze Plug Openings in the Engine

P/N	DESCRIPTION
2949	120V, 1000W, 3054B, 4023L Engine Heater



MBE 900 ENGINE HEATER

P/N	DESCRIPTION
2942	1000W Engine Heater with Plate



NAVISTAR DT-466 ENGINE HEATER

- 120 Volt

P/N	DESCRIPTION
2914	1250W, FP Engine Heater



NAVISTAR & FORD 6.9/7.3L ENGINE HEATER

P/N	DESCRIPTION
2933	1000W, FP Engine Heater



NAVISTAR & INTERNATIONAL ENGINE HEATER

- Navistar/International In-Line 6-Cylinder All Series: 312, 360, 414, 436, 466, DT466, and 530
- Mounts in the Frost Plug on the Left Side of the Engine

P/N	DESCRIPTION
2946	120V, 1500W Engine Heater



OIL PAN HEATER

P/N	DESCRIPTION
2924	300W, 1" NPT Oil Pan Heater



FLUSH MOUNTING KIT FOR TANK HEATERS

- For Heaters with Wattage of 500-1800

P/N	DESCRIPTION
2948	120V, 15A Flush Mounting Kit



TANK HEATER

- Tank Type for All Engines
- 5/8" Inlet and Outlet

P/N	DESCRIPTION
2927	1500W Tank Type Tank Heater



TANK HEATER

- 1.0 NPTF Inlet and Outlet

P/N	DESCRIPTION
2943	1500W Tank Heater



SILICONE HOT PAD

- Ideal for Oil Pans, Hydraulic Reservoirs, Engine Blocks, Hydraulic Cylinders, and Diesel Fuel Tanks
- Etched Foil Heating Element Provides Optimal Heat Transfer & Extended Life
- Durable Silicone/Fiberglass Cover Resists Abrasion
- Peel & Stick for Easy Application
- Comes Fully Assembled with Standard 6ft HPN Cord and Plug

P/N	DESCRIPTION
2923	400W, 6"x8" Silicone Hot Pad



ENGINE HEATERS

BATTERY PADS & WRAPS

- A Fully Charged Battery Has Only 40% Cranking Power at 0°F when Compared to 100% Cranking Power at 80°F. Battery Pads & Wraps Keep Your Battery at 80°F and Full Cranking Power!
- Made of a Durable, Fire-Retardant Vinyl Cover that Resists Oils & Acids
- The Standard Pads and Wraps come with 6" Grounded Cord and Plug
- 120 Volts



P/N	DESCRIPTION	WATTAGE
2930	Standard Pad for One Battery	50 W
2900	Standard Pad for One Battery	75 W
2939	Special Pads for Single Batteries	50 W
2941	Special Pads for Single Batteries	75 W
2938	Dual Battery Pad for Multiple Batteries	50 W
2940	Dual Battery Pad for Multiple Batteries	75 W
2952	28" Battery Wrap	50 W
2928	36" Battery Wrap	80 W
2953	72" Battery Wrap	160 W

POWER CORDS



P/N	DESCRIPTION
2925	11' Power Cord with Flip Cover
2926	6' Power Cord with Flip Cover
2931	6' Power Cord
2936	6' Dual Battery Pad Cord

POWER CORD ACCESSORIES



P/N	DESCRIPTION
2901	Cord Heat Shield
2922	Chrome Flip Cover
2935	Plug Housing for use with Flip Cover

GENERAL PURPOSE HOSE CLAMPS

- Made in the USA of 300 Series Stainless Steel with Slotted Hex-Head Screws

P/N	SAE SIZE	CLAMPING RANGE
491006	6	7/32" – 25/32"
491008	8	1/2" – 29/32"
491010	10	9/16" – 1-1/16"
491012	12	1-1/16" – 1-1/4"
491016	16	13/16" – 1-1/2"
491020	20	13/16" – 1-3/4"
491024	24	1-1/16" – 2"
491028	28	1-5/16" – 2-1/4"
491032	32	1-9/16" – 2-1/2"
491036	36	1-13/16" – 2-3/4"
491040	40	2-1/16" – 3"
491044	44	2-5/16" – 3-1/4"
491048	48	2-9/16" – 3-1/2"
491052	52	2-13/16" – 3-3/4"
491056	56	3-1/16" – 4"
491060	60	3-5/16" – 4-1/4"
491064	64	3-9/16" – 4-1/2"
491072	72	4-1/16" – 5"
491080	80	4-9/16" – 5-1/2"
491088	88	5-1/16" – 6"
491096	96	5-9/16" – 6-1/2"
491104	104	6-1/16" – 7"



HOSE CLAMP DISPLAY RACK

- Display Can be Wall-Mounted or Free Standing
- 23"W x 18"H
- Rack Features Space for 9 Hose Clamp Sizes
- Assortment Includes a Mix of General Purpose Clamps in Popular Sizes:

490404	x30	491024	x20
490406	x30	491028	x20
491010	x20	491032	x20
491012	x20	491036	x20
491020	x20		

P/N	DESCRIPTION
491700	Display Rack with Clamp Assortment
491701	Hose Clamp Display Rack ONLY



HOSE CLAMPS

LINER HOSE CLAMPS

- Extension of the Band as an Inner Liner Covers the Band Slots to Prevent Damage to Soft Hoses
- Made in the USA of 300 Series Stainless Steel with Slotted Hex-Head Screws



P/N	SAE SIZE	CLAMPING RANGE
491206	6	7/32" – 25/32"
491208	8	1/2" – 29/32"
491210	10	9/16" – 1-1/16"
491212	12	1-1/16" – 1-1/4"
491216	16	13/16" – 1-1/2"
491220	20	13/16" – 1-3/4"
491224	24	1-1/16" – 2"
491228	28	1-5/16" – 2-1/4"
491232	32	1-9/16" – 2-1/2"
491236	36	1-13/16" – 2-3/4"
491240	40	2-1/16" – 3"
491244	44	2-5/16" – 3-1/4"
491248	48	2-9/16" – 3-1/2"

EURO SEAL HOSE CLAMPS

- Made in the USA of 300 Series Stainless Steel with Slotted Hex-Head Screws



P/N	SAE SIZE	CLAMPING RANGE
491708	8	1/2" – 29/32"
491712	12	1-1/16" – 1-1/4"
491716	16	13/16" – 1-1/2"
491720	20	13/16" – 1-3/4"
491724	24	1-1/16" – 2"
491728	28	1-5/16" – 2-1/4"
491736	36	1-13/16" – 2-3/4"
491740	40	2-1/16" – 3"
491744	44	2-5/16" – 3-1/4"
491748	48	2-9/16" – 3-1/2"
491752	52	2-13/16" – 3-3/4"
491760	60	3-5/16" – 4-1/4"
491772	72	4-1/16" – 5"
491780	80	4-9/16" – 5-1/2"
4917104	104	6-1/16" – 7"

MINIATURE HOSE CLAMPS

- Generally Used in Small Diameter Applications Such as Air & Fuel Lines
- Allows for Installation in Tight Fitting or Difficult to Reach Areas
- Made in the USA of 300 Series Stainless Steel with Slotted Hex-Head Screws

P/N	SAE SIZE	CLAMPING RANGE
490404	4	7/32" - 5/8"
490406	6	7/32" - 25/32"



STANDARD T-BOLT HOSE CLAMPS

- Designed for Use on Engine Air-Intake
- Constructed to Endure High Engine and Turbo Temperatures
- Made in the USA



P/N	CLAMPING RANGE
491450	2-1/2" – 2-13/16"
491451	2-3/4" – 3-1/16"
491452	3" – 3-5/16"
491453	3-1/4" – 3-9/16"
491454	3-7/16" – 3-7/8"
491455	3-3/4" – 4-1/16"
491456	4-1/4" – 4-9/16"
491457	4-3/4" – 5-1/16"
491458	5-1/4" – 5-9/16"
491459	5-3/4" – 6-1/16"
491460	6-1/4" – 6-9/16"
491461	4-1/4" – 7-9/16"
491462	8-1/2" – 8-13/16"

CONSTANT TORQUE HOSE CLAMPS

- Designed to Eliminate Cold Flow Hose Leaks
- Self-Adjusting Clamp Diameter Reacts to Changes in Operational or Environmental Temperatures
- Made in the USA

P/N	CLAMPING RANGE
491310	9/16" – 1-1/16"
491312	1-1/16" – 1-1/4"
491316	13/16" – 1-1/2"
491320	13/16" – 1-3/4"
491324	1-1/16" – 2"
491300	1-1/4" – 2-1/8"
491325	1-3/4" – 2-5/8"
491330	2-1/4" – 3-1/8"
491335	2-3/4" – 3-5/8"
491340	3-1/4" – 4-1/8"
491345	3-3/4" – 4-5/8"
491350	4-1/4" – 5-1/8"
491355	4-3/4" – 5-5/8"
491360	5-1/4" – 6-1/8"

HOSE CLAMPS

STANDARD & HEAVY DUTY SPRING-LOADED T-BOLT HOSE CLAMPS

- For Use on Charged-Air-Cooling or Air-to-Air Aftercooled Applications
- Made in the USA!

P/N	TYPE	CLAMPING RANGE
491503	Standard	3.0625" – 3.375"
491504	Standard	4.0625" – 4.375"
491505	Heavy Duty	3.0625" – 3.375"
491506	Heavy Duty	4.0625" – 4.375"
491507	Heavy Duty	2.06" - 2.37"
491508	Heavy Duty	2.13" - 2.44"
491509	Heavy Duty	2.19" - 2.50"
491510	Heavy Duty	2.25" - 2.50"
491511	Heavy Duty	2.75" - 3.06"
491512	Heavy Duty	3.44" - 3.75"
491513	Heavy Duty	3.56" - 3.88"
491514	Heavy Duty	3.88" - 3.19"
491515	Heavy Duty	4.19" - 4.50"
491516	Heavy Duty	4.56" - 4.88"



TURBO V-BAND HOSE CLAMPS

- Designed to Connect Exhaust Pipe Flange to Turbo or Engine Manifold
- Provides Fast, Secure Couplings
- Features High Strength & Positive Sealing Integrity
- Constructed to Endure High Engine & Turbo Temps

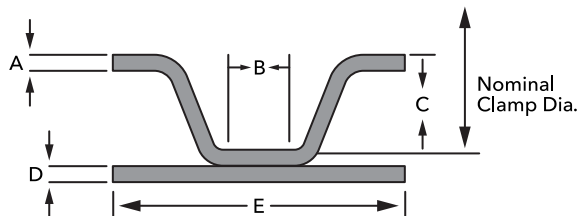

P/N	NOMINAL	A	B	C	D	E	APPLICATIONS
491620	3.21"	.050	.262	.141	.035	.750	Cummins, Freightliner, Bluebird Bus, Ford, Oshkosk
491621	3.82"	.077	.207	.281	.040	.875	CAT, GMC, Ford, DDC, Navistar
491622	3.88"	.050	.400	.281	.040	.875	Volvo, Cummins, Ford
491623	4.50"	.077	.207	.281	.040	.875	GMC, DDC, Navistar
491624	4.61"	.050	.156	.218	.035	.750	Mack, Switzer
491625	4.75"	.077	.158	.310	.040	.875	CAT, Cummins, Freightliner, GMC, Volvo, Western Star
491626	5.25"	.050	.262	.141	.035	.750	Freightliner, Navistar, DDC
491627	5.88"	.050	.400	.281	.040	.875	Cummins, DDC, CAT
491628*	5.88"	.050	.400	.281	.040	.875	Cummins, DDC, CAT

* 1-Piece Economy Version of the 491627

DIESEL FUEL TANK ANTI-SIPHON DEVICES

- Anti-Siphons are Guaranteed for the Life of the Fuel Tank they are Installed in
- Made in the USA!
- Light Weight and Easy to Install
- Extremely Secure – Stops Fuel Theft at the Source!
- Does Not Restrict the Flow of Fuel into the Tank
- Measurements are from the I.D. of the Filler Neck



P/N	APPLICATIONS	I.D.	LENGTH
431145	Volvo, Mack, and International	3.0"	7.0"
431146	Volvo, Mack, and International	2.5"	6.75"
431147	Kenworth	2.5"	9.5"
431148	Kenworth	2.0"	7.5"
431149	Freightliner	2.25"	9.5"
431150	Freightliner	2.0"	7.5"
431151	Volvo, Mack, and International*	1.875"	7.5"
431152	4" Fuel Filler Necks	4.0"	9.0"

* Fits Reefer and Medium Duty Models



431151

BRASS FUEL CAPS

- Made By Tramec Sloan in Holland, Michigan!
- All-Brass Castings for Years of Corrosion-Free Performance
- Quality Locking Feature Maintains Secure Fastening of Fuel Cap to Tank
- Fusible Elements, in Case of Fire, Melt at 190°F
- All Locking Caps Provided with Two Keys and Utilize the Same Key
- Available Vented or Non-Vented
- 8.5" Chain and Cross-Bar Combination Prevent Loss of Cap While Refueling

NOTE: Most vehicles built before October 1985 have non-vented fuel tanks. Because of the possibility of vapor lock, non-vented fuel caps should not be installed on them.



2" DIAMETER BRASS FUEL CAPS WITH FEMALE THREADS

- Threads: 2.3"-11.5 NPSM
- 3.5" Cross Bar

P/N	LOCK	VENTING
431008	No	Vented
431009	No	Non-Vented
431012	Yes	Vented
431124*	Yes	Non-Vented
431715	Replacement Brass Fuel Cap Gasket	

* Features an External Cable without Cross-Bar instead of a Chain

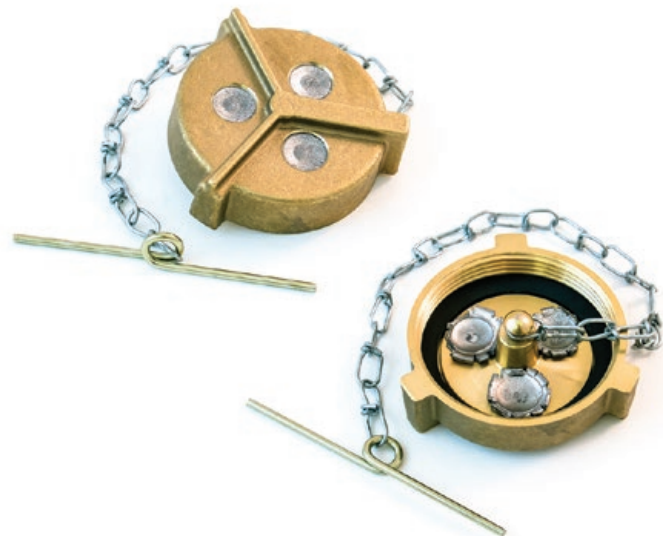

2-1/8" DIAMETER BRASS FUEL CAPS WITH MALE THREADS

- Threads: 2.125"-12 UN Male
- 3.5" Cross Bar

P/N	LOCK	VENTING
431010	No	Vented
431011	No	Non-Vented
431015	Yes	Vented
431717	Replacement Brass Fuel Cap Gasket	



2-1/2" DIAMETER BRASS FUEL CAPS WITH FEMALE THREADS

- Threads: 2.5"-8 UN
- 3.5" Cross Bar

P/N	LOCK	VENTING
431013	Yes	Non-Vented
431014	No	Non-Vented
431718	Replacement Brass Fuel Cap Gasket	



4" DIAMETER BRASS FUEL CAPS WITH FEMALE THREADS

- Threads: 4.3"-8 NPSM
- 8" Cross Bar

P/N	LOCK	VENTING
431005	No	Non-Vented
431006	Yes	Non-Vented
431731	Replacement Brass Fuel Cap Gasket	

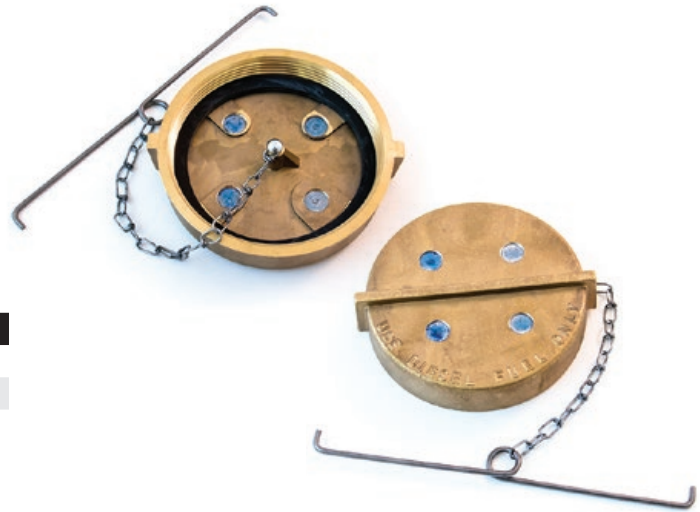

4-1/4" DIAMETER BRASS FUEL CAPS WITH MALE THREADS

- Threads: 3.7"-8 UN
- 8" Cross Bar

P/N	LOCK	VENTING
431002	No	Non-Vented
431003	Yes	Non-Vented
431702	Replacement Brass Fuel Cap Gasket	



ALUMINUM FUEL CAPS

- Attractive & Durable Aluminum Castings
- Special Compound Gasket for Tight Seal
- 12" Chain and Cross-Bar Combination Prevent Loss of Cap While Refueling
- Safety Venting Features:
 - High Capacity Pressure Relief (5-10 PSI)
 - High Capacity Thermal Relief (225°-235°F)

NOTE: Most vehicles built before October 1985 have non-vented fuel tanks. Because of the possibility of vapor lock, non-vented fuel caps should not be installed on them.



2" DIAMETER ALUMINUM FUEL CAPS WITH FEMALE THREAD

P/N	THREADS	CROSS BAR	VENTING	LOCK
431084	2.25"-11.5 NPSM	3.25"	Vented	No
431154	2.30"-11.5 NPSM	4.50"	Non-Vented	No

2-1/2" DIAMETER ALUMINUM FUEL CAP WITH FEMALE THREAD

- Threads: 2.37"-8 UN
- 3.25" Cross Bar

P/N	LOCK	VENTING
431085	No	Vented



3" DIAMETER ALUMINUM FUEL CAPS WITH FEMALE THREAD

- 7.5" Cross Bar
- Vented

P/N	THREAD	LOCK
431086	3.37"-8 NPSL	No
431087	3.37"-8 NPSL	Yes
431088	3.43"-5-1/2 Special*	No
431089	3.43"-5-1/2 Special*	Yes

* Indicates 5-1/2 Thread Count/Inch



4" DIAMETER ALUMINUM FUEL CAPS WITH FEMALE THREAD

- Threads: 4.37"-8 NPSM
- 7.5" Cross Bar

P/N	LOCK	VENTING
431090	No	Vented
431091	Yes	Vented



FREIGHTLINER STYLE FUEL CAPS

- 8" Chain and 6.5" Cross Bar
- 220°F Thermal Relief
- M2 Fuel Caps have 2.5"-8 UN Triple Lead Thread

P/N	DESCRIPTION	LOCK
431156	M2 Fuel Cap	No
431157	M2 Fuel Cap	Yes
431158	Freightliner Quarter-Turn	No
431159	Freightliner Quarter-Turn	Yes



THE ORIGINAL AXILOK® AXLE NUT

Unitized Wheel Bearing Nut System for Longer Bearing, Wheel & Tire Life

- Eliminates the Traditional Three or Four-Piece Nut Systems
- Easily Adjustable, One-Piece Assembly for Increased Speed, Accuracy, and Repeatability
- Unitized Part Consisting of Nut Body, Two Locking Clips, and a Retainer Cage
- Uses Locking Clips to Maintain Joint Security and Ensure Proper End-Play
- Axilok® Size and Socket Size Markings are Forged Into the Nut Body

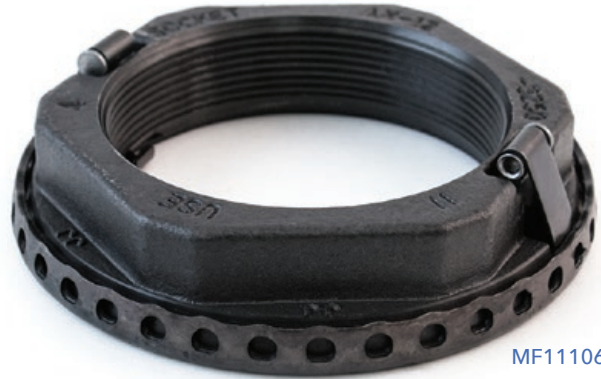

MF111062

- Significantly Reduces the Time Required for Wheel Bearing Adjustment
- Delivers Accurate Results in the Process
- Installs with Standard, Six-Sided Socket
- Saves Installation Time

AXILOK® AXLE NUTS

P/N	APPLICATION	THREAD	HEX	MVS NO.
MF111051	Trailer & Drive Axle Nut	2.625"-16	3-1/4"	AX-16-2625
MF111077	Trailer Axle Nut	3.480"-12	4-1/8"	AX-12-3480
MF111062	Drive Axle Nut	3.250"-12	4"	AX-12-3250
MF111099	Steer Axle Nut	1.500"-12	2-1/8"	AX-12-1500
MF111010	Steer Axle Nut	1.500"-18	2-1/8"	AX-18-1500

MF111051



MF111077



MF111010



MF111099



THE INDUSTRY'S BEST: SECUREX® WHEEL NUT

The Original Two-Piece Nut for Hub-Piloted Wheels



With 3-5 times more clamping force than conventional ball-seat fasteners, Securex® means **longer wheel life**, **reduced maintenance** & **greater safety**.

The Securex® design generates a bearing-type action which allows more torque to be transmitted into clamping force. This also offers a more precise torque-to-clamp force relationship, allowing the entire fastening system to be used at the optimum end of the load range.

- The Securex® Name is Forged into Each Washer to Assure Product Integrity
- The Nut Body is Made of Through-Hardened Carbon Steel
- Free-Spinning Washer is Made of Through-Hardened & Tempered Chrome Moly Steel
- Meets SAE J1965 Requirements for Torque Tension
- PTFE Coating Reduces Friction & Enhances Corrosion Protection
- Heat Lot Traceability Code on Every Fastener

P/N	THREAD	DESCRIPTION
MF110343	M22 X 1.5	33mm Flangette Hex (31mm Hi), Flat Washer, PTFE
MF111026	M22 X 1.5	33mm Hex, Flat Washer, PTFE
MF137182	M22 X 1.5	33mm Flangette Hex, Flat Washer, PTFE



HUB CAPS

HUB CAPS



P/N	SIDE FILL PLUG	BOLT CIRCLE	BOLT SIZE	# OF BOLTS	HEIGHT	INSIDE DEPTH	FLANGE I.D.	FLANGE O.D.	INCLUDES	REPLACES STEMCO
H340-4095	-	5-1/2"	5/16"	6	1-13/16"	1-1/16"	4-9/16"	6-3/16"	Gasket	340-4095
H4020	-	6-1/4" x 8 UN (M)			2-5/16"	1-9/16"	5-3/4"	6-7/8"	O-Ring	340-4020 & 340-4975
H4042	✓	5-1/8"	5/16"	6	1-9/20"	1-1/8"	4"	5-11/16"	Gasket	343-4042
H4249	-	5-1/2"	5/16"	6	1-13/16"	1-11/16"	4-7/16"	6-3/16"	Gasket	340-4249
H74009	-	5-1/2"	5/16"	6	2-11/16"	1-15/16"	4-3/8"	6-1/4"	Gasket	340-4009
H74024	-	4-1/2"	5/16"	6	2-5/8"	1-7/8"	3-1/2"	5-1/4"	Gasket	340-4024
H74075	-	6-1/4" x 8 UN (M)			2-5/16"	1-9/16"	5-3/4"	6-7/8"	O-Ring	340-4075
H74195	-	6-3/4"	5/16"	6	3-11/16"	2-15/16"	5-7/16"	7-1/2"	Gasket	340-4195
H84009H*	✓	5-1/2"	5/16"	6	3-12/25"	1-15/16"	4-3/8"	6-1/4"	Gasket	347-4009
H84024	✓	4-1/2"	5/16"	6	2-5/8"	1-7/8"	3-1/2"	5-1/4"	Gasket	343-4024
H84075	✓	6-1/4" x 8 UN (M)			2-5/16"	1-9/16"	5-3/4"	6-7/8"	O-Ring	343-4075
H84195	✓	6-3/4"	5/16"	6	3-11/16"	2-15/16"	5-7/16"	7-1/2"	Gasket	343-4195

* Includes Hubodometer

DOCUMENT HOLDERS

Durable and Designed to Keep Your Documents Safe – No Matter the Conditions!



P/N	STYLE
422324	9" Aluminum Tube-Style Document Holder
422325	4" Round Plastic Document Holder with Twist-Lock

RUBBER TARP STRAPS

- 98.8% Stretch Recovery after Being Stretched 150% of Original Length
- Packaged with "S" Hooks Attached

P/N	RELAXED LENGTH
490000	9"
490001	15"
490002	21"
490003	31"
490004	41"
490005	"S" Hooks



U-BOLT KITS & END THREADED ROD

- Proprietary Material Ensures No Cracks, No Surface Scaling, and No Warped or Twisted Legs
- Threads are Precisely Rolled to Ensure Integrity
- Excellent Corrosion Resistance and Torque Tension Properties
- No Hydrogen Embrittlement or Stress / Corrosion Cracking
- Low Temperature Cure to Maintain Part Dimensional Integrity
- **End Threaded Rod** with Center Line Mark
- **U-Bolt Kits** Contain 2 U-Bolts, 4 Washers, and 4 Nuts



ROUND U-BOLT KITS - GRADE 8

P/N	DIAMETER	WIDTH	LENGTH
TS8145-076	5/8"	5-1/16"	7-3/4"
TS8151-10	3/4"	3-1/16"	10"
TS8151-12	3/4"	3-1/16"	12"
TS8151-14	3/4"	3-1/16"	14"
TS8151-16	3/4"	3-1/16"	16"
TS8151-18	3/4"	3-1/16"	18"
TS8154-10	3/4"	4-1/16"	10"
TS8154-12	3/4"	4-1/16"	12"
TS8155-073	3/4"	5-1/16"	7-1/2"
TS8161-11	7/8"	3-1/16"	11"
TS8161-12	7/8"	3-1/16"	12"
TS8161-122	7/8"	3-1/16"	12-1/4"
TS8161-13	7/8"	3-1/16"	13"
TS8161-14	7/8"	3-1/16"	14"
TS8161-15	7/8"	3-1/16"	15"
TS8161-18	7/8"	3-1/16"	18"
TS8163-14	7/8"	3-9/16"	14"
TS8164-10	7/8"	4-1/16"	10"
TS8165-12	7/8"	5-1/16"	12"
TS8165-14	7/8"	5-1/16"	14"
TS8168-082	7/8"	6-1/16"	8-1/4"
TS8175-104	1"	5-3/16"	10-1/2"
TS8178-126	1"	5-1/16"	12-3/4"
TS8187-154	1-1/8"	5-13/16"	16"

ROUND U-BOLT KITS - GRADE 5

P/N	DIAMETER	WIDTH	LENGTH
TS5161-12	7/8"	3-1/16"	12"
TS5161-13	7/8"	3-1/16"	13"
TS5161-14	7/8"	3-1/16"	14"
TS5161-16	7/8"	3-1/16"	16"
TS5163-14	7/8"	3-9/16"	14"
TS5165-12	7/8"	5-1/16"	12"
TS5165-14	7/8"	5-1/16"	14"
TS5165-15	7/8"	5-1/16"	15"
TS5165-16	7/8"	5-1/16"	16"
TS5165-18	7/8"	5-1/16"	18"

SEMI-ROUND U-BOLT KITS - GRADE 8

P/N	DIAMETER	WIDTH	LENGTH
TS8353-15	3/4"	3-9/16"	15"
TS8354-10	3/4"	4-1/16"	10"
TS8362-19F	7/8"	3-1/16"	19"
TS8363-15N	7/8"	3-9/16"	15-3/16"
TS8375-154	1"	4-3/16"	15-1/2"
TS8394-192S	1-1/4"	4-1/16"	19-1/4"

SQUARE BEND U-BOLT KITS - GRADE 8

P/N	DIAMETER	WIDTH	LENGTH
TS8253-05	3/4"	3-9/16"	5"
TS8254-10	3/4"	4-1/16"	10"
TS8255-05	3/4"	4-1/16"	5"
TS82586-154	1-1/8"	5-3/16"	15-1/2"
TS8267-153	7/8"	5-3/16"	15-3/8"
TS8286-134	1-1/8"	5-3/16"	13-1/2"
TS8287-11	1-1/8"	5-13/16"	11"
TS8287-14	1-1/8"	5-13/16"	14"

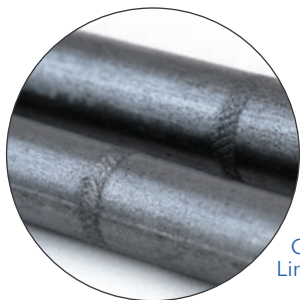

Center
Line Mark



END THREADED ROD - GRADE 5

P/N	DIAMETER	LENGTH
TR081400G5CL	1/2"	14"
TR081500G5CL	1/2"	15"
TR081600G5CL	1/2"	16"
TR081800G5CL	1/2"	18"
TR082000G5CL	1/2"	20"
TR082200G5CL	1/2"	22"
TR082400G5CL	1/2"	24"
TR083000G5CL	1/2"	30"
TR091400G5CL	9/16"	14"
TR091600G5CL	9/16"	16"
TR091800G5CL	9/16"	18"
TR092000G5CL	9/16"	20"
TR092200G5CL	9/16"	22"
TR092400G5CL	9/16"	24"
TR092600G5CL	9/16"	26"
TR092800G5CL	9/16"	28"
TR093000G5CL	9/16"	30"
TR093200G5CL	9/16"	32"
TR093400G5CL	9/16"	34"

END THREADED ROD - GRADE 8

P/N	DIAMETER	LENGTH
TR101600G8CL	5/8"	16"
TR101800G8CL	5/8"	18"
TR102000G8CL	5/8"	20"
TR102200G8CL	5/8"	22"
TR102400G8CL	5/8"	24"
TR102600G8CL	5/8"	26"
TR102800G8CL	5/8"	28"
TR103000G8CL	5/8"	30"
TR103200G8CL	5/8"	32"
TR103400G8CL	5/8"	34"
TR103600G8CL	5/8"	36"
TR103800G8CL	5/8"	38"
TR104000G8CL	5/8"	40"
TR104200G8CL	5/8"	42"
TR104800G8CL	5/8"	48"

END THREADED ROD - GRADE 8

P/N	DIAMETER	LENGTH
TR121200G8CL	3/4"	12"
TR121400G8CL	3/4"	14"
TR121600G8CL	3/4"	16"
TR121800G8CL	3/4"	18"
TR122000G8CL	3/4"	20"
TR122200G8CL	3/4"	22"
TR122400G8CL	3/4"	24"
TR122600G8CL	3/4"	26"
TR122800G8CL	3/4"	28"
TR123000G8CL	3/4"	30"
TR123200G8CL	3/4"	32"
TR123400G8CL	3/4"	34"
TR123600G8CL	3/4"	36"
TR123800G8CL	3/4"	38"
TR124000G8CL	3/4"	40"
TR124200G8CL	3/4"	42"
TR124400G8CL	3/4"	44"
TR141800G8CL	7/8"	18"
TR142000G8CL	7/8"	20"
TR142400G8CL	7/8"	24"
TR142600G8CL	7/8"	26"
TR142800G8CL	7/8"	28"
TR143000G8CL	7/8"	30"
TR143200G8CL	7/8"	32"
TR143400G8CL	7/8"	34"
TR143600G8CL	7/8"	36"
TR143800G8CL	7/8"	38"
TR144000G8CL	7/8"	40"
TR144200G8CL	7/8"	42"
TR144400G8CL	7/8"	44"
TR144800G8CL	7/8"	48"
TR145400G8CL	7/8"	54"
TR162800G8CL	1"	28"
TR163000G8CL	1"	30"
TR163200G8CL	1"	32"
TR163600G8CL	1"	36"
TR163800G8CL	1"	38"
TR183800G8CL	1-1/8"	38"
TR184200G8CL	1-1/8"	42"

#	4DA15	213	369SP-6-6.....	138	2907.....	318
4A012.....	4DA16	213	369SP-6-8.....	138	2908.....	318
4A015.....	4DA17	213	369SP-8-8.....	138	2909.....	320
4A016.....	4DC12	209	371SP-4-4.....	138	2910.....	321
4A017.....	4DC15	209	371SP-4-6.....	138	2911.....	319
4A112.....	4DC16	209	371SP-6-4-6	138	2912.....	320
4A115.....	4DC17	209	371SP-6-6.....	138	2913.....	320
4A116.....	4DD12	209	371SP-8-4-8	138	2914.....	322
4A117.....	4DD15	209	563C64-24.....	43	2915.....	318
4AA12	4DD16	209	563C64-28.5.....	43	2916.....	320
4AA15	4DD17	209	563C64-30.....	43	2917.....	318
4AA16	4X661212	78	563C64-34.5.....	43	2918.....	319
4AA17	4X663814	78	563C64-36.....	43	2919.....	321
4AC12	4X663838	78	563C64-48.....	43	2920.....	319
4AC15	35HD	184	563C64-60.....	43	2922.....	324
4AC16	37SP-4-6.....	138	563C64-72.....	43	2923.....	323
4AC17	37SP-6-4.....	138	563C64-84.....	43	2924.....	322
4AD12	45A12	218	563C64-96.....	43	2925.....	324
4AD15	45A15	218	563C64-108.....	43	2926.....	324
4AD16	45A16	218	563C64-120.....	43	2927.....	323
4AD17	45A17	218	563C64-132.....	43	2928.....	324
4B012	46A12	219	563C64-144.....	43	2929.....	321
4B015	46A15	219	563C64-156.....	43	2930.....	324
4B020	46A20	219	883-66	183	2931.....	324
4B112	47A12	218	883-86	183	2932.....	319
4B115	47A15	218	883-88	183	2933.....	322
4B120	47A16	218	883-108.....	183	2935.....	324
4BA12.....	47A17	218	886-88	183	2936.....	324
4BA15.....	48A12	219	887-88	183	2937.....	318
4BA20.....	48A15	219	887-810.....	183	2938.....	324
4BC12.....	48A20	219	889-88	183	2939.....	324
4BC15.....	61CA-2	170	984-4W.....	128	2940.....	324
4BC20.....	61CA-3	170	984-6W.....	128	2941.....	324
4BD12.....	61CA-4	170	984-8W.....	128	2942.....	322
4BD15.....	61CA-5	170	984-10W	128	2943.....	323
4BD20.....	61CA-6	170	984-12W	128	2944.....	319
4C012.....	61CA-8	170	1551A.....	172	2945.....	319
4C015.....	61CA-10.....	170	1555.....	172	2946.....	322
4C020.....	61CA-12.....	170	1556.....	174	2947.....	321
4C112.....	61CA-14.....	170	1557.....	174	2948.....	323
4C115.....	62CA-2	171	1564.....	172	2949.....	322
4C120.....	62CA-3	171	1571.....	174	2951.....	321
4CA12	62CA-4	171	1572.....	174	2952.....	324
4CA15	62CA-5	171	1582.....	174	2953.....	324
4CA20	62CA-5-4	171	1668-10.....	172	2954.....	319
4CC12	62CA-6	171	1668-10-6	172	2956.....	321
4CC15	62CA-6-4.....	171	1668-12.....	172	6001.....	292
4CC20	62CA-8	171	1669-6-6.....	174	6002.....	292
4CD12.....	62CA-8-6	171	1669-10-6	174	6004.....	292
4CD15.....	62CA-10.....	171	2616.....	290	6006.....	293
4CD20.....	62CA-12.....	171	2618.....	290	6010.....	293
4D012.....	62H-4-12.....	179	2620.....	290	6012.....	293
4D015.....	207-4	148	2622.....	290	6013.....	293
4D016.....	207-5	148	2624.....	290	6014.....	294
4D017.....	207-6	148	2900.....	324	6015.....	294
4D112.....	207-6HDSTL.....	148	2901.....	324	6016.....	294
4D115.....	207-6STL	148	2902.....	319	6017.....	294
4D116.....	207-8	148	2903.....	320	6018.....	295
4D117.....	369SP-4-4.....	138	2904.....	319	6019.....	295
4DA12	369SP-4-6.....	138	2905.....	318	6020.....	295
	369SP-6-4.....	138	2906.....	320	6021.....	295

6022.....	295	6221.....	314	6816FX.....	290	31002-054.....	36
6023.....	296	6222.....	314	6817.....	289	31002-056.....	36
6051.....	296	6301.....	310	6817B.....	289	31002-058.....	36
6052.....	296	6302.....	310	6817F.....	290	31002-060.....	36
6053.....	296	6304.....	307	6818.....	289	31002-062.....	36
6058.....	297	6305.....	310	6818B.....	289	31002-064.....	36
6059.....	297	6306.....	311	6818F.....	290	31002-066.....	36
6061.....	297	6307.....	311	6818FX.....	290	31002-068.....	36
6064.....	297	6309.....	307	6819.....	289	31002-070.....	36
6068.....	298	6310.....	308	6819B.....	289	31002-072.....	36
6069.....	298	6311.....	308	6819F.....	290	31002-084.....	36
6070.....	298	6313.....	311	6820.....	289	31002B.....	28
6071.....	298	6314.....	308	6820B.....	289	31002R.....	28
6073.....	299	6315.....	311	6820F.....	290	31003-012.....	36
6074.....	299	6316.....	312	6820FX.....	290	31003-014.....	36
6075.....	299	6317.....	312	6821.....	289	31003-016.....	36
6076.....	299	6319.....	312	6821B.....	289	31003-018.....	36
6077.....	300	6320.....	312	6821F.....	290	31003-020.....	36
6078.....	300	6350.....	312	6822.....	289	31003-022.....	36
6081.....	300	6352.....	313	6822B.....	289	31003-024.....	36
6082.....	300	6355.....	309	6822F.....	290	31003-026.....	36
6083.....	301	6356.....	309	6822FX.....	290	31003-028.....	36
6084.....	301	6357.....	309	6824.....	289	31003-030.....	36
6086.....	301	6358.....	310	6824B.....	289	31003-032.....	36
6088.....	301	6359.....	310	6824FX.....	290	31003-034.....	36
6089.....	301	6360.....	292	6826.....	289	31003-036.....	36
6090.....	302	6361.....	313	6826B.....	289	31003-038.....	36
6091.....	302	6362.....	313	6826FX.....	290	31003-040.....	36
6092.....	302	6716.....	288	6828.....	289	31003-042.....	36
6093.....	302	6717.....	288	6828B.....	289	31003-044.....	36
6094.....	302	6718.....	288	6828FX.....	290	31003-046.....	36
6095.....	303	6719.....	288	6832FX.....	290	31003-048.....	36
6096.....	303	6720.....	288	7818.....	165	31003-050.....	36
6097.....	303	6721.....	288	7828.....	165	31003-052.....	36
6101.....	303	6722.....	288	7829.....	165	31003-054.....	36
6102.....	303	6724.....	288	7896-3.....	163	31003-056.....	36
6103.....	304	6726.....	288	7896-4.....	163	31003-058.....	36
6104.....	304	6728.....	288	7897.....	165	31003-060.....	36
6113.....	304	6800.....	184	9946.....	287	31003-062.....	36
6114.....	304	6805.....	184	14250.....	28	31003-064.....	36
6117.....	308	6811.....	289	31002-012.....	36	31003-066.....	36
6119.....	305	6811B.....	289	31002-014.....	36	31003-068.....	36
6122.....	305	6811F.....	290	31002-016.....	36	31003-070.....	36
6123.....	308	6812.....	289	31002-018.....	36	31003-072.....	36
6124.....	309	6812B.....	289	31002-020.....	36	31003-084.....	36
6125.....	306	6812F.....	290	31002-022.....	36	31005-012.....	37
6126.....	306	6812FX.....	290	31002-024.....	36	31005-014.....	37
6127.....	309	6813.....	289	31002-026.....	36	31005-016.....	37
6128.....	307	6813B.....	289	31002-028.....	36	31005-018.....	37
6129.....	307	6813F.....	290	31002-030.....	36	31005-020.....	37
6130.....	307	6814.....	289	31002-032.....	36	31005-022.....	37
6131.....	305	6814B.....	289	31002-034.....	36	31005-024.....	37
6132.....	305	6814F.....	290	31002-036.....	36	31005-026.....	37
6133.....	306	6814FX.....	290	31002-038.....	36	31005-028.....	37
6134.....	306	6815.....	289	31002-040.....	36	31005-030.....	37
6135.....	306	6815B.....	289	31002-042.....	36	31005-032.....	37
6205.....	313	6815F.....	290	31002-044.....	36	31005-034.....	37
6208.....	313	6815FX.....	290	31002-046.....	36	31005-036.....	37
6217.....	314	6816.....	289	31002-048.....	36	31005-038.....	37
6219.....	314	6816B.....	289	31002-050.....	36	31005-040.....	37
6220.....	314	6816F.....	290	31002-052.....	36	31005-042.....	37

31005-044	37	31009-038	36	31408	123	34268	78
31005-046	37	31009-040	36	31410	123	34269	78
31005-048	37	31009-042	36	32205-60.....	42	34270	78
31005-050	37	31009-044	36	32205-72.....	42	34271	78
31005-052	37	31009-046	36	32205-78.....	42	34275	73
31005-054	37	31009-048	36	32205-84.....	42	34287	73
31005-056	37	31009-050	36	32205-90.....	42	35000	87
31005-058	37	31009-052	36	32205-96.....	42	35001-064	87
31005-060	37	31009-054	36	32205-102.....	42	35002-048	87
31005-062	37	31009-056	36	32205-108.....	42	35002-060	87
31005-064	37	31009-058	36	32205-114.....	42	35006-048	87
31005-066	37	31009-060	36	32205-120.....	42	35006-060	87
31005-068	37	31009-062	36	32205-126.....	42	35007	87
31005-070	37	31009-064	36	32205-132.....	42	35007-048	87
31005-072	37	31009-066	36	32205-138.....	42	35007-060	87
31005-084	37	31009-068	36	32205-144.....	42	35007U060.....	87
31006-012	37	31009-070	36	32205-160.....	42	35008	87
31006-014	37	31009-072	36	32206-60.....	42	35013	87
31006-016	37	31009-084	36	32206-72.....	42	35017	87
31006-018	37	31012-012	37	32206-78.....	42	35901	88
31006-020	37	31012-014	37	32206-84.....	42	35903	88
31006-022	37	31012-016	37	32206-90.....	42	35905	88
31006-024	37	31012-018	37	32206-96.....	42	35907	88
31006-026	37	31012-020	37	32206-102.....	42	35909	88
31006-028	37	31012-022	37	32206-108.....	42	36002	70
31006-030	37	31012-024	37	32206-114.....	42	36010	70
31006-032	37	31012-026	37	32206-120.....	42	36011	70
31006-034	37	31012-028	37	32206-126.....	42	36012	70
31006-036	37	31012-030	37	32206-132.....	42	36101	49
31006-038	37	31012-032	37	32206-138.....	42	36101U.....	49
31006-040	37	31012-034	37	32206-144.....	42	36131	58
31006-042	37	31012-036	37	32206-160.....	42	36131P.....	58
31006-044	37	31012-038	37	34015	77	36131U.....	58
31006-046	37	31012-040	37	34017	77	36131UP.....	58
31006-048	37	31012-042	37	34022	78	36153	50
31006-050	37	31012-044	37	34051	77	36153U.....	50
31006-052	37	31012-046	37	34056	77	36154	50
31006-054	37	31012-048	37	34058	77	36154U.....	50
31006-056	37	31012-050	37	34060	77	36156	50
31006-058	37	31012-052	37	34061	77	36156U.....	50
31006-060	37	31012-054	37	34063	77	36159	50
31006-062	37	31012-056	37	34118	78	36161	49
31006-064	37	31012-058	37	34150	78	36161P.....	61
31006-066	37	31012-060	37	34160	78	36161U.....	49
31006-068	37	31012-062	37	34161	78	36161UP.....	61
31006-070	37	31012-064	37	34170	79	36181	51
31006-072	37	31012-066	37	34171	79	36181P.....	57
31006-084	37	31012-068	37	34200	72	36181U.....	51
31009-012	36	31012-070	37	34211	73	36181UP.....	57
31009-014	36	31012-072	37	34212	73	36182	57
31009-016	36	31012-084	37	34213	73	36191	51
31009-018	36	31102B	28	34220	73	36191P.....	57
31009-020	36	31102R	28	34228	79	36191U.....	51
31009-022	36	31302	124	34229	79	36191UP.....	57
31009-024	36	31303	124	34241	73	36192	57
31009-026	36	31305	124	34246	79	36201	49
31009-028	36	31306	124	34247	79	36201U.....	49
31009-030	36	31402	123	34250	73	36231	58
31009-032	36	31402POP.....	124	34251	73	36231P.....	58
31009-034	36	31403	123	34259	72	36231U.....	58
31009-036	36	31407	123	34260	72	36231UP.....	58

36253	50	38282	235	38520	229	45116	216
36253U	50	38283	235	38521	229	45117	216
36254	50	38290	235	38523	229	46012	217
36254U	50	38292	235	38526	229	46015	217
36256	50	38296	235	38527	229	46020	217
36256U	50	38298	235	38540	230	46112	217
36261	49	38304	232	38541	230	46115	217
36261P	61	38305	232	38550-15	230	46120	217
36261U	49	38306	232	38550-20	230	47012	216
36261UP	61	38307	232	38550-30	230	47015	216
36281	51	38310	233	38551-15	230	47016	216
36281P	57	38312	233	38551-20	230	47017	216
36281U	51	38340	234	38551-30	230	47112	216
36281UP	57	38341	234	38560	230	47115	216
36282	57	38342	234	38561	230	47116	216
36291	51	38343	234	38570	229	47117	216
36291P	57	38344	234	38571	229	48012	217
36291U	51	38345	234	38705	235	48015	217
36291UP	57	38350	234	38706	235	48020	217
36292	57	38351	234	38707	229	48112	217
36301	49	38360	233	38714	236	48115	217
36301U	49	38361	233	38720	229	48120	217
36380	56	38394	235	38800	237	50008	147
36385	56	38395	235	38801	237	50009	147
36390	56	38396	235	38802	238	51100	98
36395	56	38397	235	38803	238	51101	98
36401	69	38402-04	236	38804	238	51102	98
36406	69	38403-04	236	38805	238	51103	98
36407	69	38407-04	236	38810	237	51104	98
36413	69	38408-04	236	38811	237	51106	99
36416	69	38410-04	236	38812	237	51107	99
36420	69	38412-04	236	38813	237	51110	98
38013	276	38421	238	38814	237	51140	98
38033	276	38422	238	38815	237	51142	98
38035	276	38423	238	38820	238	51143	98
38042	276	38424	236	38821	238	51301	106
38043	276	38440	234	38822	238	51302	106
38044	276	38441	234	38823	238	51305	106
38046	276	38442	234	38824	238	51321	107
38053	276	38443	234	38825	238	51322	107
38183-12	222	38444	234	38830	238	51325	107
38183-15	222	38445	234	38831	238	51350	96
38183-17	222	38450	234	38832	238	51351	96
38183S12	222	38451	234	38833	238	55207	145
38183S15	222	38452	234	38834	238	55243	58
38184	222	38453	234	38835	238	55244	58
38200	233	38460	234	38844	232	55286	58
38202	233	38461	234	38845	232	55287	58
38204	240	38462	234	38848	232	55290	58
38210	233	38463	234	38849	232	55291	58
38211	233	38464	234	38860	237	55404	146
38212	233	38465	234	38861	237	55600	146
38213	233	38492	235	41023-30	46	55600-BN	146
38214	233	38493	236	41023-42	46	55600STL	146
38215	233	38501	229	41023-65	46	55607	145
38216	233	38502	229	45012	216	55607-BN	145
38217	233	38503	229	45015	216	55607STL	145
38260	235	38505	229	45016	216	55608	147
38260B	235	38506	229	45017	216	55609	147
38265	235	38509	231	45112	216	55611	145
38265B	235	38510	231	45115	216	55611-SN	145

55611STL.....	145	63300-6.....	151	366600-78.....	40	401136.....	90
55612STL.....	147	63300-6-4.....	151	366600-84.....	40	401137.....	90
55613.....	146	63300-8.....	151	366600-90.....	40	401138.....	109
55613-BN.....	146	63300-8-2.....	151	366600-96.....	40	401139.....	109
55615.....	146	63300-8-4.....	151	366600-102.....	40	401140.....	109
55615-BN.....	146	63300-8-6.....	151	366600-108.....	40	401141.....	109
55616.....	145	63300-12.....	151	366600-114.....	40	401142.....	100
55620.....	146	63325-2.....	155	366600-120.....	40	401143.....	99
55620-SN6.....	146	63325-4.....	155	366600-126.....	40	401144.....	99
55620STL.....	146	63325-4-2.....	155	366600-132.....	40	401145.....	99
55629.....	146	63325-6.....	155	366600-138.....	40	401146.....	99
55629-BN.....	146	63325-6-4.....	155	366600-144.....	40	401147.....	116
55646.....	146	63325-8.....	155	366600-160.....	40	401148.....	114
55646-BN.....	146	63325-8-4.....	155	368800-60.....	40	401148GT.....	114
55646STL.....	146	63325-8-6.....	155	368800-72.....	40	401149.....	116
55661.....	145	63325-12.....	155	368800-78.....	40	401150.....	116
55661-BN.....	145	63325-12-8.....	155	368800-84.....	40	401151.....	116
55661STL.....	145	63400-2.....	153	368800-90.....	40	401153.....	97
55664.....	146	63400-4.....	153	368800-96.....	40	401154.....	97
55689STL.....	147	63400-4-2.....	153	368800-102.....	40	401155.....	97
55807.....	145	63400-6.....	153	368800-108.....	40	401156.....	97
55816.....	146	63400-8.....	153	368800-114.....	40	401157.....	115
55818.....	146	63400-12.....	153	368800-120.....	40	401158.....	115
56101.....	54	73151-12STLV.....	151	368800-126.....	40	401159.....	115
56101U.....	54	73220-12-8STLV.....	151	368800-132.....	40	401160.....	115
56161.....	61	73326R-02.....	154	368800-138.....	40	401161.....	115
56161U.....	61	73326R-04.....	154	368800-144.....	40	401162.....	115
56181.....	57	73326R-06.....	154	368800-160.....	40	401163.....	115
56181U.....	57	73326R-08.....	154	388800-60.....	41	401164.....	116
56191.....	57	73326R-12.....	154	388800-72.....	41	401165.....	116
56191U.....	57	73326R-16.....	154	388800-78.....	41	401168.....	103
56201.....	54	73326R-20.....	154	388800-84.....	41	401169.....	103
56201U.....	54	73326R-24.....	154	388800-90.....	41	401170.....	103
56261.....	61	73326R-36.....	154	388800-96.....	41	401171.....	95
56261U.....	61	73355-2.....	153	388800-102.....	41	401180.....	90
56281.....	57	73355-4.....	153	388800-108.....	41	401181.....	96
56281U.....	57	73355-6.....	153	388800-114.....	41	401182.....	104
56291.....	57	73355-8.....	153	388800-120.....	41	401188.....	108
56291U.....	57	73355-12.....	153	388800-126.....	41	401189.....	108
56301.....	54	73455-2.....	153	388800-132.....	41	401190.....	117
56301U.....	54	73455-4.....	153	388800-138.....	41	401201.....	104
59001-MA141.....	68	73455-6.....	153	388800-144.....	41	401202.....	104
59001-MA145.....	68	73455-6-4.....	153	388800-160.....	41	401206.....	97
59001-MA150.....	68	73455-8.....	153	401008.....	95	401207.....	97
59001-MA160.....	68	346600-60.....	41	401009.....	95	401209.....	90
63200-2.....	152	346600-72.....	41	401012.....	95	401210.....	102
63200-4.....	152	346600-78.....	41	401017.....	95	401211.....	101
63200-4-2.....	152	346600-84.....	41	401018.....	95	401212.....	98
63200-6.....	152	346600-90.....	41	401019.....	95	401213.....	100
63200-6-2.....	152	346600-96.....	41	401029.....	91	401214.....	283
63200-6-4.....	152	346600-102.....	41	401032.....	91	401215.....	283
63200-8.....	152	346600-108.....	41	401035.....	91	401216.....	88
63200-8-4.....	152	346600-114.....	41	401039.....	92	401217.....	118
63200-8-6.....	152	346600-120.....	41	401040.....	92	401218.....	118
63200-12-8.....	152	346600-126.....	41	401084.....	91	401219.....	118
63220-8-2.....	152	346600-132.....	41	401130.....	101	401220.....	102
63220-12-8.....	152	346600-138.....	41	401131.....	101	401221.....	108
63220-16-12.....	152	346600-144.....	41	401132.....	102	401223.....	108
63300-2.....	151	346600-160.....	41	401133.....	101	401226.....	104
63300-4.....	151	366600-60.....	40	401134.....	90	401227.....	104
63300-4-2.....	151	366600-72.....	40	401135.....	90	401228.....	97

401229	105	401748	110	421144	268	421331	221
401230	278	401749	110	421145	221	421332	221
401232	92	401777	109	421146	221	421333	221
401233	92	401778	109	421147	224	421334	221
401234	105	401796	111	421148	224	421335	221
401235	105	401797	114	421149	235	421336	221
401236	105	401798	111	421151	224	421337	221
401237	100	401799	111	421156	214	421338	221
401238	277	401800	111	421157	214	421758	226
401239	277	401801	111	421159	215	421808	259
401240	277	401802	111	421160	215	421809	259
401241	277	401803	111	421162	224	421810	259
401244	93	401804	113	421170	225	421998	275
401245	93	401805	113	421171	238	421999	275
401246	93	401806	113	421172	221	422000	255
401247	93	401807	112	421173	221	422001	255
401248	93	401808	112	421174	225	422002	255
401250	93	401809	113	421175	225	422003	255
401253	116	401810	114	421176	239	422004	255
401254	116	401811	111	421177	224	422005	255
401255	116	401812	182	421178	215	422006	255
401256	116	401814	182	421179	215	422007	255
401257	116	401815	182	421181	223	422008	255
401261	110	401816	117	421182	223	422009	255
401262	110	401817	117	421183	223	422010	255
401263	110	401818	97	421184	223	422011	257
401270	88	401819	92	421187	223	422012	257
401274	102	401824	92	421188	223	422013	257
401275	100	401825	92	421189	223	422014	257
401279	98	401826	92	421190	223	422015	256
401280	99	401827	92	421191	223	422016	256
401281	108	401828	92	421192	223	422017	256
401283	108	401829	92	421193	223	422018	255
401284	108	401830	92	421194	223	422019	255
401286	96	401831	92	421195	223	422020	255
401289	94	401832	92	421196	223	422021	257
401290	94	401833	92	421197	223	422022	257
401291	94	421000	224	421198	223	422023	256
401292	94	421001	224	421200	214	422024	256
401293	94	421015	239	421201	214	422025	255
401297	94	421119	239	421202	214	422026	255
401299	94	421121	239	421203	214	422027	255
401301	94	421122	225	421213	215	422028	255
401303	94	421123	239	421214	215	422029	255
401304	117	421124	239	421215	215	422030	255
401305	117	421126	238	421236	221	422031	255
401306	118	421127	225	421246	241	422032	255
401307	118	421128	241	421296	221	422033	255
401308	116	421131	225	421297	221	422034	255
401311	115	421132	239	421298	221	422035	255
401315	88	421133	225	421300	221	422036	255
401349	109	421134	239	421301	221	422037	255
401705	93	421135	225	421302	221	422038	255
401708	93	421136	239	421309	221	422039	255
401710	93	421137	225	421324	225	422040	255
401712	93	421138	239	421325	225	422041	255
401714	93	421139	226	421326	238	422042	255
401716	93	421140	279	421327	221	422043	255
401725	93	421141	268	421328	221	422044	256
401727	93	421142	268	421329	221	422045	256
401747	110	421143	268	421330	221	422046	256

422047	256	422112	261	422175	259	422243	242
422048	254	422113	263	422176	265	422244	242
422049	254	422114	263	422177	265	422245	242
422050	254	422115	263	422178	265	422246	242
422051	254	422116	263	422179	265	422247	242
422052	254	422117	263	422180	265	422248	242
422053	254	422118	263	422181	265	422249	242
422054	254	422119	263	422182	265	422250	242
422055	254	422120	263	422183	265	422251	242
422056	257	422121	263	422184	265	422252	242
422057	257	422122	263	422185	265	422253	242
422058	257	422123	264	422186	265	422254	242
422059	257	422124	264	422187	265	422255	242
422060	257	422125	264	422188	265	422256	242
422061	257	422126	264	422189	265	422257	242
422062	256	422128	262	422190	265	422258	242
422063	256	422129	264	422191	265	422259	242
422064	258	422130	264	422192	266	422260	242
422069	257	422131	262	422193	266	422261	242
422070	257	422133	262	422194	266	422262	242
422071	258	422134	262	422195	266	422263	242
422072	258	422135	262	422196	266	422264	242
422073	258	422136	262	422197	266	422265	242
422074	258	422137	262	422198	266	422266	242
422075	258	422138	262	422199	272	422267	242
422076	258	422139	262	422200	272	422268	242
422077	258	422140	262	422202	272	422269	242
422078	258	422141	262	422204	272	422270	242
422079	258	422142	262	422205	273	422271	248
422080	258	422143	262	422206	273	422272	248
422081	258	422144	262	422207	273	422273	243
422082	261	422145	265	422208	273	422274	243
422083	261	422146	265	422209	272	422275	243
422084	261	422147	265	422210	273	422276	243
422085	261	422148	265	422211	273	422277	243
422086	261	422149	265	422212	274	422278	243
422087	261	422150	265	422213	274	422279	243
422088	261	422151	265	422214	274	422280	243
422089	261	422152	265	422215	245	422280-1000	243
422090	261	422153	267	422216	245	422281	243
422091	261	422154	267	422217	245	422281-1000	243
422092	261	422155	267	422218	245	422282	243
422093	261	422156	267	422219	245	422282-1000	243
422094	261	422157	267	422220	245	422283	243
422095	261	422158	267	422221	245	422283-1000	243
422096	261	422159	260	422222	245	422284	243
422097	261	422160	260	422223	245	422284-1000	243
422098	261	422161	260	422224	245	422285	243
422099	261	422162	260	422225	245	422285-1000	243
422100	261	422163	260	422226	245	422286	243
422101	261	422164	260	422227	245	422286-1000	243
422102	261	422165	260	422228	245	422287	243
422103	261	422166	259	422229	245	422287-1000	243
422104	261	422167	259	422230	245	422288	243
422105	261	422168	259	422231	245	422288-1000	243
422106	261	422169	259	422232	245	422289	243
422107	261	422170	259	422233	245	422289-1000	243
422108	261	422171	259	422234	245	422290	243
422109	261	422172	259	422240	247	422290-1000	243
422110	261	422173	259	422241	242	422291	243
422111	261	422174	259	422242	242	422291-1000	243

422292	243	422368	254	422433	255	422502	244
422292-1000	243	422369	254	422434	255	422503	244
422293	243	422370	254	422435	255	422504	261
422293-1000	243	422371	254	422436	255	422505	261
422294	244	422372	254	422437	255	422506	261
422294-1000	244	422373	254	422438	255	422507	261
422295	244	422374	254	422439	255	422508	261
422295-1000	244	422375	254	422440	254	422509	261
422296	244	422376	254	422441	254	422510	266
422296-1000	244	422377	254	422442	254	422511	266
422297	244	422378	258	422443	254	422512	266
422297-1000	244	422379	258	422444	254	422513	255
422298	244	422380	258	422445	254	422514	255
422298-1000	244	422381	258	422446	254	422515	255
422299	244	422382	258	422447	254	422516	255
422299-1000	244	422383	258	422448	256	422517	255
422300	244	422387	257	422449	256	422518	255
422300-1000	244	422388	257	422450	256	422519	255
422301	244	422389	257	422451	256	422520	255
422302	244	422390	257	422454	257	422521	255
422303	244	422391	257	422455	257	422522	255
422304	244	422392	257	422458	257	422523	255
422305	244	422393	263	422459	257	422524	264
422306	244	422394	263	422460	257	422525	264
422307	244	422395	263	422461	257	422526	266
422308	244	422396	263	422462	257	422527	266
422309	244	422397	263	422463	257	422528	266
422310	246	422398	263	422464	256	422529	266
422311	246	422399	263	422465	256	422530	266
422312	246	422400	263	422466	256	422531	266
422313	246	422401	263	422467	256	422532	266
422314	246	422402	263	422471	245	422533	266
422317	226	422403	263	422472	246	422534	266
422324	337	422404	263	422473	246	422535	255
422325	337	422405	263	422474	246	422536	255
422327	241	422406	263	422475	246	422537	255
422328	241	422407	264	422477	245	422538	255
422329	241	422408	264	422478	247	422539	255
422345	265	422409	264	422479	245	422540	255
422346	265	422410	264	422480	247	422541	256
422347	265	422412	262	422481	245	422542	254
422348	265	422413	262	422482	245	422543	256
422349	265	422414	262	422483	245	422544	255
422350	265	422415	248	422484	245	422545	255
422351	265	422416	248	422485	247	422546	255
422352	265	422417	248	422486	247	422547	255
422353	265	422418	248	422487	247	422548	254
422354	265	422419	248	422488	247	422549	256
422355	265	422420	248	422489	247	422550	257
422356	265	422421	255	422490	247	422551	257
422357	265	422422	255	422491	247	422552	255
422358	265	422423	255	422492	244	422553	255
422359	265	422424	255	422493	244	422554	255
422360	265	422425	255	422494	247	422555	255
422361	265	422426	255	422495	247	422556	254
422362	265	422427	255	422496	247	422557	256
422363	254	422428	255	422497	247	422559	256
422364	254	422429	255	422498	247	422560	256
422365	254	422430	255	422499	244	422561	274
422366	254	422431	255	422500	244	422562	256
422367	254	422432	255	422501	244	422563	256

422564.....	254	422634.....	241	422711.....	283	422815.....	271
422565.....	254	422635.....	241	422712.....	283	422816.....	271
422567.....	256	422636.....	248	422713.....	283	422817.....	271
422568.....	256	422637.....	248	422714.....	283	422818.....	271
422569.....	258	422638.....	248	422720.....	257	422819.....	271
422570.....	258	422639.....	266	422721.....	257	422820.....	271
422571.....	255	422640.....	266	422722.....	257	422821.....	271
422572.....	255	422642.....	280	422750.....	270	422822.....	271
422573.....	255	422643.....	278	422751.....	270	422823.....	271
422574.....	256	422645.....	278	422752.....	270	422824.....	271
422575.....	255	422648.....	280	422753.....	270	422825.....	271
422576.....	255	422649.....	280	422754.....	270	422826.....	271
422577.....	254	422651.....	278	422755.....	270	422827.....	271
422578.....	256	422652.....	281	422762.....	268	422828.....	271
422579.....	256	422653.....	281	422763.....	268	422829.....	271
422580.....	256	422655.....	268	422764.....	268	422830.....	271
422581.....	255	422656.....	268	422765.....	268	422831.....	271
422583.....	256	422657.....	268	422766.....	268	422832.....	271
422584.....	258	422658.....	268	422767.....	268	422833.....	271
422585.....	258	422661.....	280	422770.....	268	422834.....	271
422586.....	258	422662.....	280	422773.....	268	422835.....	271
422587.....	258	422663.....	280	422774.....	268	422836.....	271
422588.....	258	422664.....	280	422775.....	268	422837.....	81
422589.....	258	422665.....	280	422776.....	268	422838.....	81
422590.....	258	422666.....	280	422777.....	268	423000P.....	196
422591.....	258	422667.....	280	422778.....	268	423001P.....	196
422592.....	260	422668.....	280	422779.....	268	423002P.....	196
422593.....	260	422669.....	280	422780.....	268	423003P.....	196
422594.....	260	422671.....	280	422781.....	268	423004P.....	196
422595.....	259	422672.....	280	422782.....	269	423005P.....	196
422596.....	259	422673.....	280	422783.....	269	423006P.....	196
422597.....	259	422674.....	280	422784.....	269	423007P.....	196
422598.....	260	422675.....	280	422785.....	269	423008P.....	196
422599.....	267	422676.....	280	422786.....	269	423009P.....	196
422600.....	267	422677.....	280	422787.....	269	423010P.....	196
422601.....	267	422679.....	280	422788.....	269	423011P.....	196
422602.....	267	422680.....	280	422789.....	269	423012P.....	196
422603.....	267	422681.....	281	422790.....	270	423013P.....	196
422605.....	267	422682.....	281	422791.....	270	423014P.....	196
422606.....	267	422684.....	281	422792.....	270	423015P.....	196
422607.....	267	422685.....	279	422793.....	270	423016P.....	196
422608.....	267	422686.....	279	422794.....	270	423017P.....	196
422610.....	267	422687.....	279	422795.....	270	423018P.....	196
422611.....	267	422688.....	279	422796.....	270	423019P.....	196
422612.....	267	422690.....	279	422797.....	270	423020P.....	196
422614.....	267	422692.....	281	422798.....	270	423021P.....	197
422615.....	267	422693.....	281	422799.....	270	423022P.....	197
422616.....	267	422694.....	281	422800.....	270	423023P.....	197
422617.....	267	422695.....	281	422801.....	270	423024P.....	197
422618.....	267	422696.....	282	422802.....	270	423025P.....	197
422620.....	267	422697.....	282	422803.....	270	423026P.....	197
422621.....	267	422698.....	282	422804.....	270	423027P.....	197
422623.....	267	422699.....	269	422805.....	270	423028P.....	197
422624.....	267	422700.....	269	422806.....	270	423029P.....	197
422627.....	267	422701.....	269	422807.....	270	423030P.....	197
422628.....	267	422702.....	269	422808.....	270	423031P.....	197
422629.....	267	422703.....	269	422810.....	270	423032P.....	197
422630.....	267	422705.....	282	422811.....	271	423033P.....	197
422631.....	267	422707.....	282	422812.....	271	423034P.....	197
422632.....	267	422709.....	277	422813.....	271	423035P.....	197
422633.....	267	422710.....	277	422814.....	271	423036P.....	197

424083P.....	197	424144P.....	198	431012.....	330	431405.....	124
424084P.....	197	424145P.....	198	431013.....	331	431405D.....	124
424085P.....	197	424146P.....	198	431014.....	331	431406.....	124
424086P.....	197	424147P.....	198	431015.....	330	431408.....	125
424087P.....	197	424148P.....	198	431084.....	332	431408-100.....	125
424088P.....	197	424149P.....	198	431085.....	332	431410.....	125
424089P.....	197	424150P.....	198	431086.....	333	431410-100.....	125
424090P.....	197	424176.....	195	431087.....	333	441000.....	63
424091P.....	197	424177.....	195	431088.....	333	441001.....	63
424092P.....	197	424200P.....	200	431089.....	333	441003.....	63
424093P.....	197	424201P.....	200	431090.....	333	441004.....	63
424094P.....	197	424202P.....	200	431091.....	333	441005.....	63
424095P.....	197	424203P.....	200	431093.....	317	441007.....	63
424096P.....	197	424204P.....	200	431094.....	317	441008.....	63
424097P.....	197	424205P.....	200	431095.....	317	441012.....	63
424098P.....	197	424206P.....	200	431096.....	317	441014.....	63
424099P.....	197	424207P.....	200	431098.....	317	441015.....	53
424100P.....	198	424220P.....	198	431099.....	317	441016.....	53
424101P.....	198	424221P.....	198	431100.....	317	441017.....	53
424102P.....	198	424222P.....	198	431101.....	317	441018.....	60
424103P.....	198	424223P.....	198	431102.....	317	441019.....	60
424104P.....	198	424224P.....	198	431103.....	317	441022.....	60
424105P.....	198	424225P.....	198	431104.....	317	441023.....	60
424106P.....	198	424226P.....	198	431105.....	317	441024.....	60
424107P.....	198	424227P.....	198	431106.....	317	441025.....	60
424108P.....	198	424238P.....	199	431107.....	317	441026.....	60
424109P.....	198	424239P.....	199	431108.....	317	441027.....	60
424110P.....	198	424240P.....	199	431116.....	316	441047.....	69
424111P.....	198	424241P.....	199	431117.....	316	441050.....	53
424112P.....	198	424242P.....	199	431118.....	316	441051.....	53
424113P.....	198	424243P.....	199	431119.....	316	441052.....	53
424114P.....	198	424244P.....	199	431120.....	316	441056.....	53
424115P.....	198	424245P.....	199	431121.....	316	441057.....	53
424116P.....	198	424247P.....	199	431124.....	330	441058.....	53
424117P.....	198	424248P.....	199	431130.....	316	441059.....	53
424118P.....	198	424249P.....	199	431131.....	316	441060.....	53
424119P.....	198	424250P.....	199	431132.....	316	441062.....	59
424120P.....	198	424251P.....	199	431133.....	316	441063.....	59
424121P.....	198	424252P.....	199	431134.....	317	441064.....	59
424122P.....	198	424253P.....	199	431135.....	317	441065.....	60
424123P.....	198	424254P.....	199	431136.....	317	441066.....	60
424124P.....	198	424302.....	192	431137.....	317	441067.....	60
424125P.....	198	424303.....	192	431145.....	329	441068.....	60
424126P.....	198	424304.....	193	431146.....	329	441069.....	59
424127P.....	198	424305.....	195	431147.....	329	441070.....	59
424128P.....	198	424306.....	195	431148.....	329	441071.....	63
424129P.....	198	424307.....	193	431149.....	329	441072.....	63
424130P.....	198	424314.....	126	431150.....	329	441074.....	60
424131P.....	198	424315.....	126	431151.....	329	441075.....	60
424132P.....	198	424316.....	127	431152.....	329	441078.....	53
424133P.....	198	424317.....	127	431154.....	332	441079.....	53
424134P.....	198	424318.....	194	431156.....	333	441080.....	63
424135P.....	198	424319.....	194	431157.....	333	441081.....	63
424136P.....	198	431002.....	331	431158.....	333	441088.....	55
424137P.....	198	431003.....	331	431159.....	333	441089.....	55
424138P.....	198	431005.....	331	431402.....	123	441089F.....	55
424139P.....	198	431006.....	331	431402-12.....	124	441090.....	55
424140P.....	198	431008.....	330	431402-100.....	124	441091.....	55
424141P.....	198	431009.....	330	431403.....	123	441091F.....	55
424142P.....	198	431010.....	330	431403-12.....	124	441092.....	55
424143P.....	198	431011.....	330	431403-100.....	124	441093.....	53

441094.....	53	441223.....	65	441832.....	71	451032NG-500.....	27
441095.....	71	441224.....	63	441833.....	71	451032R.....	27
441095D.....	71	441225.....	63	441834.....	71	451032R-500.....	27
441095P.....	71	441226.....	65	441835.....	71	451032Y.....	27
441098.....	60	441227.....	65	441841.....	71	451032Y-500.....	27
441099.....	60	441228.....	66	441843.....	70	451033.....	27
441102.....	59	441228-10.....	66	441844.....	70	451033-100.....	27
441103.....	59	441229.....	66	451001.....	78	451033-250.....	27
441104.....	59	441229-10.....	66	451009.....	79	451033B.....	27
441105.....	59	441233.....	52	451027.....	28	451033B-250.....	27
441106.....	59	441234.....	62	451027A.....	28	451033G.....	27
441114.....	53	441235.....	62	451028.....	28	451033G-250.....	27
441115.....	53	441240.....	65	451028A.....	28	451033NG.....	27
441129.....	67	441241.....	65	451029.....	26	451033NG-250.....	27
441130.....	67	441242.....	65	451029-50.....	26	451033R.....	27
441131.....	55	441243.....	65	451029-250.....	26	451033R-250.....	27
441132.....	55	441244.....	66	451029-1000.....	26	451033Y.....	27
441133.....	55	441245.....	66	451029-2000.....	26	451033Y-250.....	27
441141.....	53	441246.....	66	451030.....	26	451034.....	27
441142.....	53	441247.....	66	451030-250.....	26	451034-250.....	27
441145.....	53	441248.....	59	451030-500.....	26	451034B-250.....	27
441148.....	62	441249.....	59	451030-1000.....	26	451034G.....	27
441149.....	62	441250.....	59	451030B.....	26	451034G-50.....	27
441150.....	59	441251.....	59	451030B-500.....	26	451034G-250.....	27
441151.....	59	441252.....	53	451030B-1000.....	26	451034NG.....	27
441152.....	59	441253.....	53	451030G.....	26	451034NG-50.....	27
441153.....	59	441261.....	53	451030G-500.....	26	451034NG-250.....	27
441154.....	59	441262.....	55	451030G-1000.....	26	451034R.....	27
441155.....	59	441263.....	55	451030NG.....	26	451034R-50.....	27
441161.....	62	441264.....	55	451030NG-500.....	26	451034R-250.....	27
441161L.....	62	441265.....	59	451030NG-1000.....	26	451035.....	24
441162.....	62	441266.....	59	451030P.....	26	451035B.....	24
441162L.....	62	441267.....	62	451030P-1000.....	26	451035MV.....	22
441164.....	62	441268.....	62	451030R.....	26	451035MVB.....	22
441164L.....	62	441721.....	68	451030R-500.....	26	451035MVP.....	24
441165.....	62	441736.....	70	451030R-1000.....	26	451035MVR.....	22
441165L.....	62	441737.....	70	451030S-1000.....	26	451035N.....	21
441169.....	62	441738.....	70	451030WH-1000.....	26	451035NB.....	21
441170.....	62	441739.....	70	451030Y.....	26	451035NBS.....	23
441171.....	62	441747.....	73	451030Y-1000.....	26	451035NP.....	24
441172.....	62	441748.....	73	451031.....	27	451035NR.....	21
441175.....	52	441749.....	70	451031-50.....	27	451035NRS.....	23
441176.....	52	441750.....	63	451031-500.....	27	451035NS.....	23
441177.....	52	441751.....	67	451031B.....	27	451035R.....	24
441178.....	52	441751-12.....	67	451031B-500.....	27	451036.....	24
441199.....	62	441752-01.....	68	451031G.....	27	451036B.....	24
441200.....	62	441752-03.....	68	451031G-500.....	27	451036MV.....	22
441203.....	55	441790.....	70	451031NG.....	27	451036MVB.....	22
441204.....	55	441799.....	67	451031NG-500.....	27	451036MVP.....	24
441205.....	63	441799-12.....	67	451031R.....	27	451036MVR.....	22
441206.....	63	441818.....	55	451031R-500.....	27	451036N.....	21
441207.....	63	441819.....	55	451031Y.....	27	451036NB.....	21
441208.....	63	441820.....	55	451031Y-500.....	27	451036NBS.....	23
441209.....	53	441821.....	55	451032.....	27	451036NP.....	24
441210.....	53	441822.....	69	451032-50.....	27	451036NR.....	21
441211.....	53	441823.....	70	451032-500.....	27	451036NRS.....	23
441212.....	62	441824.....	69	451032B.....	27	451036NS.....	23
441213.....	62	441828.....	71	451032B-500.....	27	451036R.....	24
441214.....	60	441829.....	71	451032G.....	27	451037.....	78
441215.....	60	441830.....	71	451032G-500.....	27	451038.....	78
441222.....	65	441831.....	71	451032NG.....	27	451039.....	24

451039B.....	24	451088.....	78	451181.....	8	451280.....	10
451039MV.....	22	451089.....	11	451182.....	8	451281.....	10
451039MVB.....	22	451089N.....	22	451183.....	7	451301.....	25
451039MVP.....	24	451089NB.....	22	451184.....	7	451302.....	25
451039MVR.....	22	451089NR.....	22	451185.....	7	451706.....	77
451039N.....	21	451090N.....	22	451186.....	7	451707.....	77
451039NB.....	21	451090NB.....	22	451187.....	7	451708.....	77
451039NBS.....	23	451090NR.....	22	451188.....	7	451711.....	76
451039NP.....	24	451091N.....	23	451189.....	8	451712.....	77
451039NR.....	21	451091NB.....	23	451190.....	8	451713.....	76
451039NRS.....	23	451091NR.....	23	451191.....	8	451715.....	52
451039NS.....	23	451092N.....	21	451192.....	8	451716.....	76
451039R.....	24	451092NB.....	21	451193.....	8	451717.....	76
451040N.....	23	451092NR.....	21	451194.....	8	451718.....	76
451040NB.....	23	451093N.....	21	451198.....	7	451720.....	76
451040NR.....	23	451093NB.....	21	451201.....	7	451721.....	76
451041N.....	23	451093NR.....	21	451202.....	7	451722.....	76
451041NB.....	23	451094.....	77	451204.....	8	451723.....	76
451041NR.....	23	451095.....	77	451205.....	8	451724.....	76
451042N.....	23	451096.....	11	451206.....	8	451725.....	76
451042NB.....	23	451097.....	7	451208.....	12	451726.....	77
451042NR.....	23	451098.....	7	451209.....	12	451727.....	77
451044.....	28	451099.....	7	451210.....	12	451728.....	77
451045.....	28	451100.....	27	451211.....	12	451729.....	77
451046.....	77	451101.....	68	451212.....	13	451732.....	77
451047.....	77	451102.....	25	451213.....	13	451733.....	77
451048.....	77	451103.....	25	451215.....	13	451734.....	77
451049.....	77	451104.....	25	451216.....	13	451735.....	77
451050.....	77	451105.....	25	451218.....	74	451736.....	77
451051.....	77	451106.....	11	451221.....	13	451737.....	77
451052.....	77	451107.....	7	451222.....	13	451738.....	76
451053.....	77	451108.....	7	451223.....	13	451739.....	76
451054.....	27	451114.....	7	451224.....	13	451740.....	76
451054-500.....	27	451116.....	11	451226.....	13	451741.....	76
451055.....	25	451117.....	11	451227.....	13	451742.....	76
451056N.....	21	451118.....	11	451228.....	13	451743.....	76
451056NB.....	21	451119.....	7	451231.....	13	451744.....	76
451056NR.....	21	451120.....	7	451232.....	13	451745.....	76
451057.....	72	451121.....	7	451233.....	13	451746.....	76
451058.....	72	451122.....	9	451234.....	13	451747.....	76
451059.....	72	451123.....	9	451235.....	13	451748.....	76
451060.....	72	451124.....	9	451236.....	13	451749.....	76
451061N.....	21	451125.....	9	451237.....	13	451750.....	76
451061NB.....	21	451126.....	73	451238.....	13	451751.....	76
451061NR.....	21	451128.....	73	451239.....	13	451752.....	76
451062.....	28	451129.....	9	451240.....	13	451755.....	76
451063.....	28	451130.....	9	451241.....	13	451756.....	76
451064N.....	23	451131.....	9	451242.....	13	451757.....	76
451064NB.....	23	451139.....	9	451243N.....	21	452000.....	44
451064NR.....	23	451140.....	9	451243NB.....	21	452001.....	44
451066.....	24	451141.....	9	451243NR.....	21	452002.....	44
451067.....	26	451149.....	9	451244.....	25	452108.....	35
451067-50.....	26	451150.....	9	451257.....	10	452108MAX.....	33
451067-1000.....	26	451151.....	9	451258.....	10	452112.....	35
451068.....	26	451159.....	9	451259.....	10	452112MAX.....	33
451068-50.....	26	451160.....	9	451260.....	10	452114.....	35
451068-250.....	26	451161.....	9	451266.....	10	452114MAX.....	33
451068-1000.....	26	451169.....	74	451267.....	10	452116.....	35
451069.....	78	451170.....	80	451274.....	7	452116MAX.....	33
451080.....	78	451178.....	74	451275.....	8	452118.....	35
451087.....	76	451180.....	8	451279.....	10	452118MAX.....	33

452120.....	35	452224MAX.....	33	452356MAX.....	33	453208.....	34
452120MAX.....	33	452226.....	35	452360MAX.....	33	453208MAX.....	32
452122.....	35	452226MAX.....	33	452366MAX.....	33	453212.....	34
452122MAX.....	33	452228.....	35	452372MAX.....	33	453212MAX.....	32
452124.....	35	452228MAX.....	33	452384MAX.....	33	453214.....	34
452124MAX.....	33	452230.....	35	453108.....	34	453214MAX.....	32
452126.....	35	452230MAX.....	33	453108MAX.....	32	453216.....	34
452126MAX.....	33	452232.....	35	453112.....	34	453216MAX.....	32
452128.....	35	452232MAX.....	33	453112MAX.....	32	453218.....	34
452128MAX.....	33	452234.....	35	453114.....	34	453218MAX.....	32
452130.....	35	452234MAX.....	33	453114MAX.....	32	453220.....	34
452130MAX.....	33	452236.....	35	453116.....	34	453220MAX.....	32
452132.....	35	452236MAX.....	33	453116MAX.....	32	453222.....	34
452132MAX.....	33	452238.....	35	453118.....	34	453222MAX.....	32
452134.....	35	452238MAX.....	33	453118MAX.....	32	453224.....	34
452134MAX.....	33	452240.....	35	453120.....	34	453224MAX.....	32
452136.....	35	452240MAX.....	33	453120MAX.....	32	453226.....	34
452136MAX.....	33	452242.....	35	453122.....	34	453226MAX.....	32
452138.....	35	452242MAX.....	33	453122MAX.....	32	453228.....	34
452138MAX.....	33	452244.....	35	453124.....	34	453228MAX.....	32
452140.....	35	452244MAX.....	33	453124MAX.....	32	453230.....	34
452140MAX.....	33	452246.....	35	453126.....	34	453230MAX.....	32
452142.....	35	452246MAX.....	33	453126MAX.....	32	453232.....	34
452142MAX.....	33	452248MAX.....	33	453128.....	34	453232MAX.....	32
452144.....	35	452250.....	35	453128MAX.....	32	453234.....	34
452144MAX.....	33	452250MAX.....	33	453130.....	34	453234MAX.....	32
452146.....	35	452252.....	35	453130MAX.....	32	453236.....	34
452146MAX.....	33	452252MAX.....	33	453132.....	34	453236MAX.....	32
452148.....	35	452254.....	35	453132MAX.....	32	453238.....	34
452148MAX.....	33	452256.....	35	453134.....	34	453238MAX.....	32
452150.....	35	452256MAX.....	33	453134MAX.....	32	453240.....	34
452150MAX.....	33	452260.....	35	453136.....	34	453240MAX.....	32
452152.....	35	452260MAX.....	33	453136MAX.....	32	453242.....	34
452152MAX.....	33	452266.....	35	453138.....	34	453242MAX.....	32
452154.....	35	452266MAX.....	33	453138MAX.....	32	453244.....	34
452154MAX.....	33	452272.....	35	453140.....	34	453244MAX.....	32
452156.....	35	452272MAX.....	33	453140MAX.....	32	453246.....	34
452156MAX.....	33	452284.....	35	453142.....	34	453246MAX.....	32
452160.....	35	452284MAX.....	33	453142MAX.....	32	453248.....	34
452160MAX.....	33	452308MAX.....	33	453144.....	34	453248MAX.....	32
452166.....	35	452312MAX.....	33	453144MAX.....	32	453250.....	34
452166MAX.....	33	452314MAX.....	33	453146.....	34	453250MAX.....	32
452172.....	35	452316MAX.....	33	453146MAX.....	32	453252.....	34
452172MAX.....	33	452318MAX.....	33	453148.....	34	453252MAX.....	32
452184.....	35	452320MAX.....	33	453148MAX.....	32	453254.....	34
452184MAX.....	33	452322MAX.....	33	453150.....	34	453254MAX.....	32
452208.....	35	452324MAX.....	33	453150MAX.....	32	453256.....	34
452208MAX.....	33	452326MAX.....	33	453152.....	34	453256MAX.....	32
452212.....	35	452328MAX.....	33	453152MAX.....	32	453260.....	34
452212MAX.....	33	452330MAX.....	33	453154.....	34	453260MAX.....	32
452214.....	35	452332MAX.....	33	453154MAX.....	32	453266.....	34
452214MAX.....	33	452334MAX.....	33	453156.....	34	453266MAX.....	32
452216.....	35	452336MAX.....	33	453156MAX.....	32	453272.....	34
452216MAX.....	33	452338MAX.....	33	453160.....	34	453272MAX.....	32
452218.....	35	452340MAX.....	33	453160MAX.....	32	453284.....	34
452218MAX.....	33	452342MAX.....	33	453166.....	34	453284MAX.....	32
452220.....	35	452344MAX.....	33	453166MAX.....	32	453308.....	35
452220MAX.....	33	452346MAX.....	33	453172.....	34	453308MAX.....	32
452222.....	35	452348MAX.....	33	453172MAX.....	32	453312.....	35
452222MAX.....	33	452350MAX.....	33	453184.....	34	453312MAX.....	32
452224.....	35	452352MAX.....	33	453184MAX.....	32	453314.....	35

453314MAX.....	32	453432	34	455042	31	455240PMAXXSET	17
453316	35	453434	34	455044	31	455240PMAXXSETW.....	18
453316MAX.....	32	453436	34	455046	31	455240PRMAXX.....	15
453318	35	453438	34	455048	31	455240R.....	15
453318MAX.....	32	453440	34	455050	31	455240RMAXX.....	15
453320	35	453442	34	455052	31	455240SET.....	17
453320MAX.....	32	453444	34	455056	31	455240SETW.....	18
453322	35	453446	34	455060	31	456008	31
453322MAX.....	32	453448	34	455066	31	456012	31
453324	35	453450	34	455072	31	456014	31
453324MAX.....	32	453452	34	455084	31	456016	31
453326	35	453454	34	455144	15	456018	31
453326MAX.....	32	453456	34	455144AB	15	456020	31
453328	35	453460	34	455144AR	15	456022	31
453328MAX.....	32	453466	34	455144ASET.....	17	456024	31
453330	35	453472	34	455144ASETW.....	18	456026	31
453330MAX.....	32	453484	34	455144B.....	15	456028	31
453332	35	454008	31	455144BMAXX.....	15	456030	31
453332MAX.....	32	454012	31	455144DSET.....	17	456032	31
453334	35	454014	31	455144DSETW.....	18	456034	31
453334MAX.....	32	454016	31	455144MAXXSET.....	17	456036	31
453336	35	454018	31	455144MAXXSETW.....	18	456038	31
453336MAX.....	32	454020	31	455144PBMAXX	15	456040	31
453338	35	454022	31	455144PMAXXSET	17	456042	31
453338MAX.....	32	454024	31	455144PMAXXSETW....	18	456044	31
453340	35	454026	31	455144PRMAXX.....	15	456046	31
453340MAX.....	32	454027	31	455144R.....	15	456048	31
453342	35	454028	31	455144RMAXX.....	15	456050	31
453342MAX.....	32	454030	31	455144SET.....	17	456052	31
453344	35	454032	31	455144SETW.....	18	456056	31
453344MAX.....	32	454034	31	455180	15	456060	31
453346	35	454036	31	455180AB	15	456066	31
453346MAX.....	32	454038	31	455180AR	15	456072	31
453348	35	454040	31	455180ASET.....	17	456084	31
453348MAX.....	32	454042	31	455180ASETW.....	18	460048	19
453350	35	454044	31	455180B.....	15	460052	19
453350MAX.....	32	454046	31	455180BMAXX.....	15	460072	19
453352	35	454048	31	455180DSET.....	17	460084	19
453352MAX.....	32	454050	31	455180DSETW.....	18	460096	19
453354	35	454052	31	455180MAXXSET.....	17	460108	19
453356	35	454056	31	455180MAXXSETW.....	18	460120	19
453356MAX.....	32	454060	31	455180PBMAXX	15	460144	19
453360	35	454066	31	455180PMAXXSET	17	460156	19
453360MAX.....	32	454072	31	455180PMAXXSETW....	18	460168	19
453366	35	454084	31	455180PRMAXX.....	15	460180	19
453366MAX.....	32	455008	31	455180R.....	15	461001	84
453372	35	455012	31	455180RMAXX.....	15	461002	84
453372MAX.....	32	455014	31	455180SET.....	17	461003	84
453384	35	455016	31	455180SETW.....	18	461004	84
453384MAX.....	32	455018	31	455240	15	461005	84
453408	34	455020	31	455240AB	15	461006	83
453412	34	455022	31	455240AR	15	461007	83
453414	34	455024	31	455240ASET.....	17	461008	86
453416	34	455026	31	455240ASETW.....	18	461009	86
453418	34	455028	31	455240B.....	15	461010	86
453420	34	455030	31	455240BMAXX.....	15	461011	87
453422	34	455032	31	455240DSET.....	17	461012	84
453424	34	455034	31	455240DSETW.....	18	461016	86
453426	34	455036	31	455240MAXXSET.....	17	461017	86
453428	34	455038	31	455240MAXXSETW.....	18	461018	84
453430	34	455040	31	455240PBMAXX	15	461019	84

461020	83	462252	45	491345	327	491805	181
461022	86	462254	45	491350	327	491806	181
461023	83	462260	45	491355	327	491807	180
461024	86	462272	45	491360	327	491808	180
461025	84	462284	45	491450	327	491809	180
461026	83	462318	46	491451	327	491810	180
461027	83	462324	46	491452	327	491811	181
461029	84	462336	46	491453	327	491812	181
461032	84	490000	337	491454	327	491813	180
461033	84	490001	337	491455	327	491814	180
461034	84	490002	337	491456	327	491815	180
461035	86	490003	337	491457	327	491816	180
461036	86	490004	337	491458	327	491817	180
461037	84	490005	337	491459	327	492000	80
461039	86	490404	326	491460	327	492001	80
461040	84	490406	326	491461	327	492002	80
461045	83	491006	325	491462	327	492003	80
461046	86	491008	325	491503	328	492004	80
461112	43	491010	325	491504	328	492005	80
461115	43	491012	325	491505	328	492006	80
461116	43	491016	325	491506	328	492007	80
461117	43	491020	325	491507	328	492008	80
461118	43	491024	325	491508	328	492009	80
461120	43	491028	325	491509	328	492100	80
461124	43	491032	325	491510	328	492101	80
461126	43	491036	325	491511	328	492102	80
461127	43	491040	325	491512	328	492103	80
461128	43	491044	325	491513	328	492104	80
461129	43	491048	325	491514	328	492105	80
461130	43	491052	325	491515	328	492106	80
461132	43	491056	325	491516	328	492107	80
461134	43	491060	325	491620	328	492108	80
461136	43	491064	325	491621	328	492109	80
461209	119	491072	325	491622	328	492110	80
461212	119	491080	325	491623	328	492111	80
461216	119	491088	325	491624	328	492112	80
461220	119	491096	325	491625	328	492113	80
461224	119	491104	325	491626	328	492200	248
461230	119	491206	326	491627	328	492201	248
461236	119	491208	326	491628	328	492202	248
462000	46	491210	326	491700	325	500001	252
462001	46	491212	326	491701	325	500002	252
462002	46	491216	326	491708	326	500003	252
462018	45	491220	326	491712	326	500004	253
462024	45	491224	326	491716	326	500005	253
462030	45	491228	326	491720	326	500006	253
462036	45	491232	326	491724	326	500007	253
462048	45	491236	326	491728	326	500008	253
462060	45	491240	326	491736	326	500009	252
462118	46	491244	326	491740	326	500010	252
462124	46	491248	326	491744	326	500011	253
462130	46	491300	327	491748	326	500012	253
462136	46	491310	327	491752	326	500013	253
462148	46	491312	327	491760	326	500014	253
462218	45	491316	327	491772	326	500015	253
462224	45	491320	327	491780	326	500016	253
462230	45	491324	327	491800	181	500017	250
462232	45	491325	327	491801	181	500130	250
462236	45	491330	327	491802	181	500140	250
462242	45	491335	327	491803	181	500150	250
462248	45	491340	327	491804	181	500160	250

F36153U	50	F56261U	61	HU125-10-12	179	LF73326-2	189
F36154	50	F56281	57	HU125-12-12	179	LF73326-4	189
F36154U	50	F56281U	57	HU126-8-12	179	LF73326-6	189
F36156	50	F56291	57	HU126-8-12H	179	LF73326-8	189
F36156U	50	F56291U	57	HU126-10-12	179	LF73326-12	189
F36161	49	F56301	54	HU126-10-12H	179	LF73327-4	189
F36161P	61	F56301U	54	HU126-12-12H	179	LF73327-6	189
F36161U	49	F56321	55	HUF22-12-12	178	LF73327-8	189
F36161UP	61	FC-6	162	HUS11-8-12	178	LF73600-6	189
F36181	51	FO-6	162	HUS11-12-12	178	LF73750-4	189
F36181P	57	FRC11-6-6	162	HUS-12	178	LF73750-6	189
F36181U	51	FRC13-6-8	162	J		LFHU125-8-12	189
F36181UP	57	FRC16-6-6	162	JN114W	148	LFHU125-10-12	189
F36182	57	FRC18-6-8	162	JN3416W	148	LFHU125-12-12	189
F36191	51	FT3-6	162	JN7820	148	LW100	148
F36191P	57	FU3-6	162	L		LW340	148
F36191U	51	G		LF40-4	187	LW780	148
F36191UP	57	GH1004	63	LF40-6	187	LW1125	148
F36192	57	GH1014	63	LF40-8	187	M	
F36201	49	GH5500	70	LF40-10	187	MF110343	335
F36201U	49	GH6600	70	LF41S-4	187	MF111010	334
F36231	58	GH7700	70	LF41S-6	187	MF111026	335
F36231P	58	H		LF41S-8	187	MF111051	334
F36231U	58	H340-4095	336	LF42-6	187	MF111062	334
F36231UP	58	H4020	336	LF42-10	187	MF111077	334
F36253	50	H4042	336	LF46-6-6	187	MF111099	334
F36253U	50	H4249	336	LF46-6-8	187	MF137182	335
F36254	50	H74009	336	LF46-8-6	187	MV31516	286
F36254U	50	H74024	336	LF46-8-8	187	MV31516B	286
F36256	50	H74075	336	LF46-8-12	187	MV31517	286
F36256U	50	H74195	336	LF48-4-4	187	MV31518	286
F36261	49	H84009H	336	LF48-4-8	187	MV31518B	286
F36261P	61	H84024	336	LF48-6-2	187	MV31519	286
F36261U	49	H84075	336	LF62-6-4	188	MV31520	286
F36261UP	61	H84195	336	LF62-8-6	188	MV31520B	286
F36281	51	HC-1	177	LF62-10-8	188	MV31522	286
F36281U	51	HC-8	177	LF141S-6	188	MV31522B	286
F36281UP	57	HFU22-6-12	177	LF141S-8	188	MV31524	286
F36282	57	HFU22-8-12	177	LF141S-10	188	MV31524B	286
F36291	51	HNH-1	177	LF73129-6	188	N	
F36291P	57	HPHN-6-4	155	LF73129-8	188	NC3416CL	148
F36291U	51	HPHN-8-6	155	LF73129-12	188	ND7820YL	148
F36291UP	57	HPHN-8-8	155	LF73151-2	188	NE114WCL	148
F36292	57	HPHN-12-8	155	LF73151-4	188	NV101-4-2	184
F36301	49	HPHN-12-12	155	LF73151-8	188	NV101-5-2	184
F36301U	49	HS666-IT	79	LF73151-12	188	NV101-6-4	184
F56101	54	HS666-VT	79	LF73152-2	188	NV102-4	184
F56101U	54	HS6666-U	79	LF73152-4	188	NV102-6	184
F56121	55	HU11-8-12	177	LF73155-6	188	NV103-4-2	185
F56121P	55	HU11-12-12	177	LF73155-8	188	NV103-4-4	185
F56161	61	HU12-8-12	178	LF73220-4-2	188	NV103-6-4	185
F56161U	61	HU12-12-12	178	LF73220-6-4	188	NV104-3-2	185
F56181	57	HU21-8-12	178	LF73220-8-4	188	NV104-4-2	185
F56181U	57	HU21-12-12	178	LF73220-8-6	188	NV104-4-4	185
F56191	57	HU22-8-12	179	LF73220-12-8	188	NV104-5-2	185
F56191U	57	HU22-12-12	179	LF73300-4	189	NV104-6-4	185
F56201	54	HU22-12MH	179	LF73300-6	189	NV105-3	185
F56201U	54	HU125-8-12	179	LF73300-8	189	NV105-4	185
F56221	55						
F56221P	55						
F56261	61						

NV105-5.....	185	S41L-5.....	157	S46-10-12.....	159	S50-6-8.....	159
NV105-6.....	185	S41L-6.....	157	S46-12-8.....	159	S50-8-8.....	159
NV106-3-2.....	185	S41L-8.....	157	S46-12-12.....	159	S50-10-8.....	159
NV106-4-2.....	185	S41L-10.....	157	S46-14-12.....	159	S51-10B.....	47
NV106-4-4.....	185	S41S-2.....	157	S46IF-3-2.....	164	S51-12B.....	47
NV106-5-2.....	185	S41S-3.....	157	S46IF-4-2.....	164	S52-10.....	47
NV106-6-4.....	185	S41S-4.....	157	S46IF-5-2.....	164	S52-10C.....	47
NV107-2.....	185	S41S-5.....	157	S46IF-6-4.....	164	S52-12.....	47
NV107-4.....	185	S41S-6.....	157	S46IF-8-6.....	164	S52-12C.....	47
NV108-2.....	185	S41S-7.....	157	S48-2-2.....	158	S53-8-10.....	47
NV108-4.....	185	S41S-8.....	157	S48-3-2.....	158	S54-10-10.....	47
P		S41S-10.....	157	S48-4-2.....	158	S54-12-12.....	47
PSB640.....	185	S41S-12.....	157	S48-4-4.....	158	S55-4.....	159
R		S41S-14.....	157	S48-4-6.....	158	S55-6.....	159
R455144.....	16	S42-2.....	158	S48-4-8.....	158	S55-10.....	159
R455144AR.....	16	S42-3.....	158	S48-5-2.....	158	S56-10-10.....	47
R455144PRMAXX.....	16	S42-4.....	158	S48-5-4.....	158	S56-12-12.....	47
R455144R.....	16	S42-5.....	158	S48-5-6.....	158	S57-8-10.....	47
R455144RMAXX.....	16	S42-6.....	158	S48-6-2.....	158	S57-10-10.....	47
R455180.....	16	S42-6-4.....	158	S48-6-4.....	158	S57-12-12.....	47
R455180AR.....	16	S42-6-5.....	158	S48-6-6.....	158	S60-2.....	166
R455180PRMAXX.....	16	S42-8.....	158	S48-6-8.....	158	S60-3.....	166
R455180R.....	16	S42-8-4.....	158	S48-6-12.....	158	S60-4.....	166
R455180RMAXX.....	16	S42-8-6.....	158	S48-8-4.....	158	S60-5.....	166
R455240.....	16	S42-10.....	158	S48-8-6.....	158	S60-6.....	166
R455240AR.....	16	S42-10-6.....	158	S48-8-8.....	158	S60-7.....	166
R455240PRMAXX.....	16	S42-10-8.....	158	S48-8-12.....	158	S60-8.....	166
R455240R.....	16	S42-12.....	158	S48-10-4.....	158	S60-10.....	166
R455240RMAXX.....	16	S42-12-8.....	158	S48-10-6.....	158	S60-12.....	166
S		S42IF-2.....	165	S48-10-8.....	158	S60-14.....	166
S39-4.....	157	S42IF-3.....	165	S48-10-12.....	158	S60PT-4.....	166
S39-5.....	157	S42IF-4.....	165	S48-12-8.....	158	S60PT-5.....	166
S39-6.....	157	S42IF-5.....	165	S48-12-12.....	158	S60PT-6.....	166
S39-8.....	157	S42IF-6.....	165	S48-14-12.....	158	S60PT-8.....	166
S39-10.....	157	S42IF-8.....	165	S48IF-2-2.....	164	S60PT-10.....	166
S40-3.....	156	S44-3.....	161	S48IF-3-2.....	164	S60TF-2.....	149
S40-4.....	156	S44-4.....	161	S48IF-4-2.....	164	S60TF-5/32.....	149
S40-5.....	156	S44-5.....	161	S48IF-4-4.....	164	S61-2.....	167
S40-6.....	156	S44-6.....	161	S48IF-5-2.....	164	S61-3.....	167
S40-8.....	156	S44-6-6-8.....	161	S48IF-5-4.....	164	S61-4.....	167
S40-10.....	156	S44-8.....	161	S48IF-6-2.....	164	S61-5.....	167
S40-12.....	156	S44-10.....	161	S48IF-6-4.....	164	S61-6.....	167
S41IF-2.....	163	S45-6-2.....	160	S48IF-6-6.....	164	S61-7.....	167
S41IF-3.....	163	S46-3-2.....	159	S48IF-8-4.....	164	S61-8.....	167
S41IF-4.....	163	S46-4-2.....	159	S48IF-8-6.....	164	S61-10.....	167
S41IF-5.....	163	S46-4-4.....	159	S48IF-8-8.....	164	S61-12.....	167
S41IF-6.....	163	S46-4-6.....	159	S48IF-10-8.....	164	S61-14.....	167
S41IF-8.....	163	S46-4-8.....	159	S49-3-2.....	160	S61CP-4.....	167
S41IFS-2.....	163	S46-5-2.....	159	S49-4-2.....	160	S61CP-6.....	167
S41IFS-3.....	163	S46-5-4.....	159	S49-4-4.....	160	S61CP-8.....	167
S41IFS-4.....	163	S46-6-2.....	159	S49-4-6.....	160	S61CP-10.....	167
S41IFS-5.....	163	S46-6-4.....	159	S49-5-2.....	160	S61L-2.....	167
S41IFS-6.....	163	S46-6-6.....	159	S49-5-4.....	160	S61L-3.....	167
S41IFS-8.....	163	S46-6-8.....	159	S49-6-2.....	160	S61L-4.....	167
S41IFS-10.....	163	S46-6-12.....	159	S49-6-4.....	160	S61L-5.....	167
S41IFS-12.....	163	S46-8-4.....	159	S49-6-6.....	160	S61L-6.....	167
S41L-4.....	157	S46-8-6.....	159	S49-8-4.....	160	S61L-8.....	167
		S46-8-8.....	159	S49-8-6.....	160	S61L-10.....	167
		S46-8-12.....	159	S49-8-8.....	160	S61L-12.....	167
		S46-10-6.....	159	S49-10-8.....	160	S61TF-2.....	149
		S46-10-8.....	159	S50-6-6.....	159	S61TF-5/32.....	149

S62-2	168	S65CA-5	170	S68-10-12	167	S69-10-6	169
S62-3	168	S65CA-6	170	S68-12-8	167	S69-10-8	169
S62-4	168	S65CA-8	170	S68-12-12	167	S69CA-2-2	170
S62-4-2	168	S66-2-2	168	S68-14-8	167	S69CA-3-2	170
S62-4-3	168	S66-3-2	168	S68-14-12	167	S69CA-4-2	170
S62-5	168	S66-3-4	168	S68-14-16	167	S69CA-4-4	170
S62-5-4	168	S66-4-2	168	S68CA-2-2	171	S69CA-4-6	170
S62-6	168	S66-4-4	168	S68CA-3-2	171	S69CA-5-4	170
S62-6-4	168	S66-4-6	168	S68CA-3-4	171	S69CA-5-6	170
S62-6-5	168	S66-4-8	168	S68CA-4-2	171	S69CA-6-2	170
S62-7	168	S66-5-2	168	S68CA-4-4	171	S69CA-6-4	170
S62-8	168	S66-5-4	168	S68CA-4-6	171	S69CA-6-6	170
S62-8-6	168	S66-6-2	168	S68CA-5-2	171	S69CA-8-6	170
S62-10	168	S66-6-4	168	S68CA-5-4	171	S69CA-8-8	170
S62-10-6	168	S66-6-6	168	S68CA-6-2	171	S69TF-2-1	149
S62-10-8	168	S66-6-8	168	S68CA-6-4	171	S69TF-2-2	149
S62-12	168	S66-8-4	168	S68CA-6-6	171	S69TF-5/32-2	149
S62-14	168	S66-8-6	168	S68CA-6-8	171	S70-3-2	168
S62BH-4	167	S66-8-8	168	S68CA-8-4	171	S70-4-2	168
S62BH-6	167	S66-10-6	168	S68CA-8-6	171	S70-4-4	168
S62PMT-3	131	S66-10-8	168	S68CA-8-8	171	S70-5-2	168
S62PMT-4	131	S66CA-2-2	171	S68PMT-3-2	132	S70-5-4	168
S62PMT-5	131	S66CA-4-2	171	S68PMT-4-2	132	S70-6-2	168
S62PMT-6	131	S66CA-4-4	171	S68PMT-4-4	132	S70-6-4	168
S62PMT-8	131	S66CA-6-4	171	S68PMT-4-6	132	S70-6-6	168
S62PMT-10	131	S66CA-6-6	171	S68PMT-5-4	132	S70-6-8	168
S62PMT-532	131	S66CA-6-8	171	S68PMT-6-2	132	S70-8-6	168
S62PMTBH-4	131	S66CA-8-4	171	S68PMT-6-4	132	S70-10-8	168
S62PMTBH-6	131	S66CA-8-6	171	S68PMT-6-6	132	S71-2-2	169
S62PMTBH-8	131	S66CA-8-8	171	S68PMT-6-8	132	S71-3-2	169
S62PMTBH-10	131	S66H-6-12	178	S68PMT-8-4	132	S71-4-2	169
S62TF-2	149	S66H-8-12	178	S68PMT-8-6	132	S71-4-4	169
S62TF-5/32	149	S66PMT-4-2	132	S68PMT-8-8	132	S71-5-2	169
S63PT-4	166	S66PMT-4-4	132	S68PMT-10-6	132	S71-5-4	169
S63PT-5	166	S66PMT-6-4	132	S68PMT-10-8	132	S71-6-2	169
S63PT-6	166	S66PMT-6-6	132	S68PMT-12-8	132	S71-6-4	169
S63PT-8	166	S66PMT-8-6	132	S68PMT-12-12	132	S71-6-6	169
S63PT-10	166	S66PMT-8-8	132	S68PMT-532-1	132	S71-8-6	169
S64-2	169	S68-2-1	167	S68PMT-532-2	132	S71-8-8	169
S64-3	169	S68-2-2	167	S68TF-2-1	149	S71CA-4-2	171
S64-4	169	S68-3-2	167	S68TF-2-2	149	S71CA-4-4	171
S64-5	169	S68-3-4	167	S68TF-5/32-1	149	S71CA-6-4	171
S64-6	169	S68-4-2	167	S68TF-5/32-2	149	S71CA-6-6	171
S64-6-6-4	169	S68-4-4	167	S69-2-2	169	S71CA-8-6	171
S64-8	169	S68-4-6	167	S69-3-2	169	S71CA-8-8	171
S64-8-8-6	169	S68-4-8	167	S69-3-4	169	S72-2-2	169
S64CA-2	171	S68-5-2	167	S69-4-2	169	S72-3-2	169
S64CA-3	171	S68-5-4	167	S69-4-4	169	S72-4-2	169
S64CA-4	171	S68-5-6	167	S69-4-6	169	S72-4-4	169
S64CA-6	171	S68-6-2	167	S69-5-2	169	S72-5-2	169
S64CA-8	171	S68-6-4	167	S69-5-4	169	S72-5-4	169
S65-2	168	S68-6-6	167	S69-5-6	169	S72-6-2	169
S65-3	168	S68-6-8	167	S69-6-2	169	S72-6-4	169
S65-4	168	S68-6-12	167	S69-6-4	169	S72-6-6	169
S65-5	168	S68-7-4	167	S69-6-6	169	S72-8-6	169
S65-6	168	S68-8-4	167	S69-6-8	169	S72-8-8	169
S65-7	168	S68-8-6	167	S69-7-4	169	S72-10-8	169
S65-8	168	S68-8-8	167	S69-7-6	169	S72CA-2-2	171
S65-10	168	S68-8-12	167	S69-8-4	169	S72CA-4-2	171
S65-12	168	S68-10-6	167	S69-8-6	169	S72CA-5-4	171
S65CA-4	170	S68-10-8	167	S69-8-8	169	S72CA-6-4	171

S73-3	173	S125-2-4	172	S129-8-6	174	S149-5-2	160
S73-4	173	S125-3-2	172	S129-10-6	174	S149-5-4	160
S73-5	173	S125-3-4	172	S129-10-8	174	S149-6-2	160
S73-6	173	S125-4-2	172	S131IFS-3	163	S149-6-4	160
S73-8	173	S125-4-4	172	S131IFS-4	163	S149-6-6	160
S102-2	154	S125-4-6	172	S131IFS-5	163	S149-6-8	160
S102-4	154	S125-4-8	172	S131IFS-6	163	S149-8-4	160
S102-6	154	S125-5-2	172	S139-4-2	174	S149-8-6	160
S102-8	154	S125-5-4	172	S139-5-2	174	S149-8-8	160
S102-12	154	S125-5-6	172	S139-5-4	174	S149-8-12	160
S104-2	152	S125-6-2	172	S139-6-2	174	S149-10-6	160
S104-4	152	S125-6-4	172	S139-6-4	174	S149-10-8	160
S104-6	152	S125-6-6	172	S139-6-6	174	S149-10-12	160
S104-8	152	S125-6-8	172	S139-8-4	174	S149-12-8	160
S104-12	152	S125-8-4	172	S139-8-6	174	S149-12-12	160
S113-02-1.5-R	155	S125-8-6	172	S139-10-6	174	S150-4-2	160
S113-02-2.5-R	155	S125-8-8	172	S141L-4	157	S150-4-4	160
S113-02-2-R	155	S125-8-12	172	S141L-6	157	S150-4-6	160
S113-02-3.5-R	155	S125-10-6	172	S141L-8	157	S150-5-2	160
S113-02-3-R	155	S125-10-8	172	S141L-10	157	S150-5-4	160
S113-04-1.5-R	155	S125-10-12	172	S141S-3	157	S150-6-4	160
S113-04-2.5-R	155	S125-12-8	172	S141S-4	157	S150-6-6	160
S113-04-2-R	155	S125-12-12	172	S141S-5	157	S150-6-8	160
S113-04-3.5-R	155	S125-16-12	172	S141S-6	157	S150-8-6	160
S113-04-3-R	155	S125-16-16	172	S141S-6-4	157	S150-8-8	160
S113-06-1.5-R	155	S126-2-2	173	S141S-8	157	S150-8-12	160
S113-06-2.5-R	155	S126-3-2	173	S141S-8-6	157	S150-10-6	160
S113-06-2-R	155	S126-4-2	173	S141S-10	157	S150-10-8	160
S113-06-3.5-R	155	S126-4-4	173	S141S-10-8	157	S151-3-2	161
S113-06-3-R	155	S126-4-6	173	S141S-12	157	S151-4-2	161
S113-08-1.5-R	155	S126-5-2	173	S144-2	161	S151-4-4	161
S113-08-2.5-R	155	S126-5-4	173	S144-3	161	S151-5-2	161
S113-08-2-YL	155	S126-6-2	173	S144-4	161	S151-5-4	161
S113-08-3-R	155	S126-6-4	173	S144-5	161	S151-6-2	161
S113-12-2.5-R	155	S126-6-6	173	S144-6	161	S151-6-4	161
S113-12-2-R	155	S126-6-8	173	S144-8	161	S151-6-6	161
S114FSV-4	158	S126-8-4	173	S144-10	161	S151-6-8	161
S114FSV-5	158	S126-8-6	173	S145-3-2	161	S151-8-6	161
S114FSV-6	158	S126-8-8	173	S145-4-2	161	S151-8-8	161
S114FSV-8	158	S127-4-2	173	S145-4-4	161	S151-10-8	161
S114FSV-10	158	S127-4-4	173	S145-5-2	161	S152-4	160
S119-4-2	151	S127-6-4	173	S145-5-4	161	S152-6	160
S119-6-2	151	S127-6-6	173	S145-6-2	161	S152-8	160
S119-6-4	151	S127-8-6	173	S145-6-4	161	S155-2	159
S119-8-2	151	S127-8-8	173	S145-6-6	161	S155-3	159
S119-8-4	151	S128-4-4	173	S145-6-8	161	S155-4	159
S119-8-6	151	S128-5-4	173	S145-8-6	161	S155-5	159
S119-12-8	151	S128-6-4	173	S145-8-8	161	S155-6	159
S120-2	152	S128-6-6	173	S145-10-8	161	S155-6-4	159
S120-4	152	S128-8-6	173	S145-12-12	161	S155-8	159
S120-4-2	152	S128-8-8	173	S146-4-4	173	S155-8-6	159
S120-6	152	S128-12-12	173	S146-4-6	173	S155-10	159
S120-6-2	152	S129-4-2	174	S146-6-6	173	S155-10-8	159
S120-6-4	152	S129-4-4	174	S146-6-8	173	S155-12	159
S120-8	152	S129-5-2	174	S146-8-8	173	S159-4-2	159
S120-8-4	152	S129-5-4	174	S149-2-2	160	S159-4-4	159
S120-8-6	152	S129-5-6	174	S149-3-2	160	S159-6-4	159
S120-12	152	S129-6-2	174	S149-4-2	160	S159-6-6	159
S120-12-6	152	S129-6-4	174	S149-4-4	160	S159-8-6	159
S120-12-8	152	S129-6-6	174	S149-4-6	160	S159-8-8	159
S125-2-2	172	S129-8-4	174	S149-4-8	160	S159-10-6	159

S159-10-8.....	159	S226-2	154	S259IF-6-4.....	165	S269AB-6-4.....	143
S200-2	153	S226-4	154	S259IF-8-6.....	165	S269AB-6-6.....	143
S200-4	153	S226-6	154	S260AB-4	142	S269AB-6-8.....	143
S200-6	153	S226-8	154	S260AB-6	142	S269AB-8-4.....	143
S200-8	153	S226-12.....	154	S260AB-8	142	S269AB-8-6.....	143
S200-12.....	153	S244IF-3	164	S260AB-10.....	142	S269AB-8-8.....	143
S202-2	153	S244IF-4	164	S260AB-12.....	142	S269AB-10-6	143
S202-4	153	S244IF-5	164	S261AB-4	142	S269AB-10-8	143
S202-4-2.....	153	S244IF-6	164	S261AB-6	142	S269AB-10-12	143
S202-6	153	S244IF-8	164	S261AB-8	142	S269AB-12-8	143
S202-8	153	S245IF-3-2.....	164	S261AB-10.....	142	S269PMT-2-2	133
S202-8-6.....	153	S245IF-4-2.....	164	S261AB-12.....	142	S269PMT-4-2	133
S202-12.....	153	S245IF-5-2.....	164	S262AB-4	142	S269PMT-4-4	133
S203-2	154	S245IF-6-4.....	164	S262AB-6	142	S269PMT-4-6	133
S203-4	154	S249IF-2-2.....	165	S262AB-8	142	S269PMT-5-4	133
S203-6	154	S249IF-3-2.....	165	S262AB-10.....	142	S269PMT-6-2	133
S203-8	154	S249IF-4-2.....	165	S262AB-12.....	142	S269PMT-6-4	133
S203-12.....	154	S249IF-4-4	165	S264AB-4	144	S269PMT-6-6	133
S207-2	151	S249IF-5-2.....	165	S264AB-6	144	S269PMT-6-8	133
S207-4	151	S249IF-5-4.....	165	S264AB-8	144	S269PMT-8-4	133
S207-6	151	S249IF-6-2.....	165	S264AB-10.....	144	S269PMT-8-6	133
S207-8	151	S249IF-6-4.....	165	S264PMT-4.....	134	S269PMT-8-8	133
S207-12.....	151	S249IF-6-6.....	165	S264PMT-6	134	S269PMT-10-6	133
S210-2	150	S249IF-8-4.....	165	S264PMT-8	134	S269PMT-10-8	133
S210-4	150	S249IF-8-6.....	165	S264PMT-10.....	134	S269PMT-12-8	133
S210-6	150	S249IF-8-8.....	165	S264PMT-12.....	134	S269PMT-12-12.....	133
S210-8	150	S249IF-10-6	165	S265AB-4	144	S269PMT-532-2.....	133
S211-2	151	S249IF-10-8	165	S265AB-6	144	S269PMTNS-3-2	133
S211-4	151	S250IF-4-2	165	S265AB-8	144	S269PMTNS-4-2	133
S211-6	151	S250IF-6-4.....	165	S265AB-10.....	144	S269PMTNS-4-4	133
S211-8	151	S251IF-3-2.....	164	S265PMT-4.....	132	S269PMTNS-4-6	133
S211-12.....	151	S251IF-4-2.....	164	S265PMT-6.....	132	S269PMTNS-6-2	133
S211-16.....	151	S251IF-5-2.....	164	S265PMT-8.....	132	S269PMTNS-6-4	133
S213-2	150	S251IF-6-4.....	164	S266AB-4-2.....	143	S269PMTNS-6-6	133
S213-4	150	S252IF-3-2.....	164	S266AB-4-4.....	143	S269PMTNS-6-8	133
S213-6	150	S252IF-6-4.....	164	S266AB-6-2.....	143	S269PMTNS-8-4	133
S213-8	150	S254PMT-4-2	132	S266AB-6-4.....	143	S269PMTNS-8-6	133
S213-12.....	150	S254PMT-4-4	132	S266AB-6-6.....	143	S269PMTNS-8-8	133
S215-2	154	S254PMT-6-2	132	S266AB-8-6.....	143	S269PMTNS-10-6.....	133
S215-4	154	S254PMT-6-4	132	S266AB-8-8.....	143	S269PMTNS-10-8.....	133
S215-6	154	S254PMT-6-6	132	S266AB-10-6	143	S269PMTNS-12-8.....	133
S215-8	154	S254PMT-8-4	132	S266AB-10-10	143	S269PMTNS-532-1	133
S215-12.....	154	S254PMT-8-6	132	S268AB-4-2.....	143	S269PMTNS-532-2	133
S219P-2	151	S254PMT-8-8	132	S268AB-4-4.....	143	S270AB-4-2.....	144
S219P-4	151	S254PMT-10-8	132	S268AB-4-6.....	143	S270AB-4-4.....	144
S219P-6	151	S254PMT-12-8	132	S268AB-6-2.....	143	S270AB-6-2.....	144
S219P-8	151	S254PMTNS-4-2	132	S268AB-6-4.....	143	S270AB-6-4.....	144
S219P-12.....	151	S254PMTNS-4-4	132	S268AB-6-6.....	143	S270AB-6-6.....	144
S220P-2	150	S254PMTNS-6-2	132	S268AB-6-8.....	143	S270AB-8-6.....	144
S220P-4	150	S254PMTNS-6-4	132	S268AB-8-4.....	143	S270AB-8-8.....	144
S220P-6	150	S254PMTNS-6-6.....	132	S268AB-8-6.....	143	S270AB-10-8	144
S224-2	153	S254PMTNS-6-8.....	132	S268AB-8-8.....	143	S270PMTNS-4-2	133
S224-4	153	S254PMTNS-8-4	132	S268AB-10-6	143	S270PMTNS-4-4	133
S224-6	153	S254PMTNS-8-6.....	132	S268AB-10-8	143	S270PMTNS-4-6	133
S224-8	153	S254PMTNS-8-8.....	132	S268AB-10-12	143	S270PMTNS-6-2	133
S224-12.....	153	S254PMTNS-10-6.....	132	S268AB-12-8	143	S270PMTNS-6-4	133
S225-2	154	S254PMTNS-10-8.....	132	S268AB-12-12	143	S270PMTNS-6-6.....	133
S225-4	154	S254PMTNS-12-12	132	S269AB-4-2.....	143	S270PMTNS-8-6.....	133
S225-6	154	S259IF-3-2.....	165	S269AB-4-4.....	143	S270PMTNS-8-8.....	133
S225-6-6-4	154	S259IF-4-2.....	165	S269AB-4-6.....	143	S271AB-4-2-4	144
S225-8	154	S259IF-5-2.....	165	S269AB-6-2.....	143	S271AB-4-4.....	144

S271AB-6-4.....	144	S363RB-8-6.....	141	S684-10-10.....	176	S762PMT-2.....	135
S271AB-6-6.....	144	S366RBSV-634.....	141	S688-6-6.....	176	S762PMT-3.....	135
S271AB-8-4.....	144	S366RBSV-878.....	141	S688-12-12.....	176	S762PMT-4.....	135
S271AB-8-6.....	144	S368AB-6-4.....	140	S690-4-3.....	176	S762PMT-6.....	135
S271AB-8-6-6.....	144	S368AB-6-4-1.....	140	S690-4-4.....	176	S762PMT-6-8.....	135
S271AB-8-8.....	144	S368AB-6-6.....	140	S690-5-4.....	176	S762PMT-8.....	135
S271AB-10-8.....	144	S368AB-6-6-1.....	140	S690-5-5.....	176	S762PMT-10.....	135
S271PMT-4-2.....	134	S368AB-6-8.....	140	S690-5-6.....	176	S762PMT-12-12.....	135
S271PMT-4-4.....	134	S368AB-6-8-1.....	140	S690-6-5.....	176	S762PMT-532.....	135
S271PMT-6-4.....	134	S368AB-8-6.....	140	S690-6-6.....	176	S762PMT-532-4.....	135
S271PMT-6-6.....	134	S368AB-8-6-1.....	140	S690-8-8.....	176	S762PMTBH-2.....	135
S271PMT-8-6.....	134	S368AB-8-8.....	140	S690-10-10.....	176	S762PMTBH-4.....	135
S271PMT-8-8.....	134	S368AB-8-8-1.....	140	S692-4-3.....	176	S762PMTBH-5/32-5/32.....	135
S271PMTNS-4-2.....	134	S371ABS-6.....	139	S692-4-4.....	176	S762PMTBH-6.....	135
S271PMTNS-4-4.....	134	S371ABS-8.....	139	S692-4-5.....	176	S762PMTBH-8.....	135
S271PMTNS-6-4.....	134	S371AS-6.....	139	S692-6-5.....	176	S762PMTBH-10.....	135
S271PMTNS-6-6.....	134	S371AS-8.....	139	S692-6-6.....	176	S763AB-4.....	128
S272AB-4-2.....	144	S376AB-3/4-4.....	141	S692-8-8.....	176	S763AB-6.....	128
S272AB-4-4.....	144	S376AB-3/4-6.....	141	S694-4-3.....	176	S763AB-8.....	128
S272AB-6-2.....	144	S376AB-3/4-8.....	141	S694-4-4.....	176	S763AB-10.....	128
S272AB-6-4.....	144	S376AB-7/8-6.....	141	S694-4-5.....	176	S763AB-12.....	128
S272AB-6-6.....	144	S376AB-7/8-8.....	141	S694-6-6.....	176	S764AB-4.....	130
S272AB-8-6.....	144	S378AB-6-4.....	140	S694-8-8.....	176	S764AB-4-4-6.....	130
S272AB-8-8.....	144	S378AB-6-6.....	140	S694-10-10.....	176	S764AB-6.....	130
S272AB-10-8.....	144	S378AB-6-8.....	140	S696-4.....	175	S764AB-6-6-4.....	130
S272PMT-4-2.....	134	S378AB-8-6.....	140	S696-6.....	175	S764AB-8.....	130
S272PMT-4-4.....	134	S378AB-8-8.....	140	S696-8.....	175	S764AB-8-6-8.....	130
S272PMT-6-2.....	134	S600.....	147	S696-10.....	175	S764AB-8-8-6.....	130
S272PMT-6-4.....	134	S600L.....	147	S696-12.....	175	S764AB-10.....	130
S272PMT-6-6.....	134	S607.....	147	S754PMT-2-2.....	137	S764PMT-3.....	137
S272PMT-8-4.....	134	S608.....	147	S754PMT-4-2.....	137	S764PMT-4.....	137
S272PMT-8-6.....	134	S609.....	147	S754PMT-4-4.....	137	S764PMT-4-4-6.....	137
S272PMT-8-8.....	134	S612.....	147	S754PMT-4-6.....	137	S764PMT-6.....	137
S272PMTNS-4-2.....	133	S613.....	147	S754PMT-6-2.....	137	S764PMT-6-6-4.....	137
S272PMTNS-4-4.....	133	S625-4-2.....	175	S754PMT-6-4.....	137	S764PMT-8.....	137
S272PMTNS-6-4.....	133	S625-4-4.....	175	S754PMT-6-6.....	137	S764PMT-8-8-6.....	137
S272PMTNS-6-6.....	133	S625-6-4.....	175	S754PMT-6-8.....	137	S764PMT-10.....	137
S272PMTNS-8-4.....	133	S625-6-6.....	175	S754PMT-8-4.....	137	S764YPMT-4.....	137
S272PMTNS-8-6.....	133	S625-8-6.....	175	S754PMT-8-6.....	137	S764YPMT-4-4-6.....	137
S279AB-4-2.....	143	S625-8-8.....	175	S754PMT-8-8.....	137	S764YPMT-6.....	137
S279AB-4-4.....	143	S625-10-8.....	175	S754PMT-10-6.....	137	S764YPMT-6-6-4.....	137
S279AB-6-2.....	143	S625-12-12.....	175	S754PMT-10-8.....	137	S765AB-4.....	130
S279AB-6-4.....	143	S629.....	147	S754PMT-12-6.....	137	S765AB-6.....	130
S279AB-6-6.....	143	S639PMT-4.....	131	S754PMT-12-8.....	137	S765AB-8.....	130
S279AB-6-8.....	143	S639PMT-6.....	131	S754PMT-532-2.....	137	S765AB-10.....	130
S279AB-8-6.....	143	S639PMT-8.....	131	S760AB-3.....	128	S765PMT-4.....	137
S279AB-8-8.....	143	S639PMT-532.....	131	S760AB-4.....	128	S765PMT-5/32.....	137
S279AB-10-8.....	143	S646.....	147	S760AB-6.....	128	S765PMT-6.....	137
S360AB-6.....	139	S646-S768AB-6-6.....	147	S760AB-8.....	128	S765PMT-8.....	137
S360AB-8.....	139	S682-4-4.....	175	S760AB-10.....	128	S766AB-4-2.....	129
S361AB-6.....	139	S682-4-5.....	175	S760AB-12.....	128	S766AB-4-4.....	129
S361AB-8.....	139	S682-6-6.....	175	S761AB-4.....	128	S766AB-6-2.....	129
S361ABS-6.....	139	S682-6-8.....	175	S761AB-6.....	128	S766AB-6-4.....	129
S361ABS-8.....	139	S682-8-8.....	175	S761AB-8.....	128	S766AB-6-6.....	129
S362RB-6.....	140	S682-10-8.....	175	S761AB-10.....	128	S766AB-8-6.....	129
S362RB-8.....	140	S682-10-10.....	175	S761AB-12.....	128	S766AB-8-8.....	129
S363RB-6.....	141	S682-12-10.....	175	S762AB-4.....	129	S766AB-10-6.....	129
S363RB-6-4S.....	141	S684-4-4.....	176	S762AB-6.....	129	S766AB-10-8.....	129
S363RB-6-8.....	141	S684-4-5.....	176	S762AB-8.....	129	S766PMT-4-2.....	136
S363RB-6-8S.....	141	S684-6-6.....	176	S762AB-10.....	129	S766PMT-4-4.....	136
S363RB-8.....	141	S684-8-8.....	176	S762AB-12.....	129	S766PMT-4-6.....	136

S766PMT-6-2	136	S769AB-12-12	129	S772AB-4-4	130	S983PMT-6-8L	131
S766PMT-6-4	136	S769PMT-2-2	136	S772AB-6-2	130	S983PMT-8-8	131
S766PMT-6-6	136	S769PMT-2-4	136	S772AB-6-4	130	S983PMT-8-8L	131
S766PMT-6-8	136	S769PMT-4-2	136	S772AB-6-6	130	SDC603-4	186
S766PMT-8-2	136	S769PMT-4-4	136	S772AB-8-4	130	SDC604-2	186
S766PMT-8-4	136	S769PMT-4-6	136	S772AB-8-6	130	SDC604-4	186
S766PMT-8-6	136	S769PMT-6-2	136	S772AB-8-8	130	SDC604-6	186
S766PMT-8-8	136	S769PMT-6-4	136	S772AB-10-8	130	SDC604-8	186
S766PMT-532-2	136	S769PMT-6-6	136	S772PMT-2-2	138	SFB-6	156
S768AB-4-2	129	S769PMT-6-8	136	S772PMT-2-4	138	SFB-8	156
S768AB-4-4	129	S769PMT-8-4	136	S772PMT-4-2	138	SFF209-2	186
S768AB-4-6	129	S769PMT-8-6	136	S772PMT-4-4	138	SFF209-4	186
S768AB-6-2	129	S769PMT-8-8	136	S772PMT-4-6	138	SFF209-6	186
S768AB-6-4	129	S769PMT-10-6	136	S772PMT-6-2	138	SFF209-8	186
S768AB-6-6	129	S769PMT-10-8	136	S772PMT-6-4	138	SFG-3	156
S768AB-6-8	129	S769PMT-10-12	136	S772PMT-6-6	138	SFG-4	156
S768AB-8-4	129	S769PMT-12-8	136	S772PMT-6-8	138	SFG-5	156
S768AB-8-6	129	S769PMT-12-12	136	S772PMT-8-4	138	SFG-6	156
S768AB-8-8	129	S769PMT-532-2	136	S772PMT-8-6	138	SFG-8	156
S768AB-10-6	129	S769PMT-532-4	136	S772PMT-8-8	138	SFG-10	156
S768AB-10-8	129	S770AB-4-2	130	S772PMT-10-6	138	SFG-12	156
S768AB-10-12	129	S770AB-4-4	130	S772PMT-10-8	138	SHBT2-6	174
S768AB-12-8	129	S770AB-6-2	130	S772PMT-532-1	138	SOVF45-6-12	182
S768AB-12-12	129	S770AB-6-4	130	S772PMT-532-2	138	SP34100	174
S768PMT-2-1	136	S770AB-6-6	130	S772PMT-532-4	138	SP34580	174
S768PMT-2-2	136	S770AB-8-6	130	S774AB-4	129	SPHN-2	155
S768PMT-2-4	136	S770AB-8-8	130	S774AB-6	129	SPHN-4	155
S768PMT-4-2	136	S770AB-10-8	130	S774AB-8	129	SPHN-4-2	155
S768PMT-4-4	136	S770PMT-4-2	136	S777PMT-4	138	SPHN-6	155
S768PMT-4-6	136	S770PMT-4-4	136	S777PMT-4-2	138	SPHN-6-2	155
S768PMT-6-2	136	S770PMT-4-6	136	S777PMT-6-4	138	SPHN-6-4	155
S768PMT-6-4	136	S770PMT-5/32-2	136	S777PMT-8-6	138	SPHN-8	155
S768PMT-6-6	136	S770PMT-6-2	136	S777PMT-10-4	138	SPHN-8-4	155
S768PMT-6-8	136	S770PMT-6-4	136	S779AB-4-2	130	SPHN-8-6	155
S768PMT-8-4	136	S770PMT-6-6	136	S779AB-4-4	130	SPHN-12	155
S768PMT-8-6	136	S770PMT-6-8	136	S779AB-6-2	130	SPHN-12-8	155
S768PMT-8-8	136	S770PMT-8-4	136	S779AB-6-4	130	SPPH-2	150
S768PMT-10-6	136	S770PMT-8-6	136	S779AB-6-6	130	SPPH-4	150
S768PMT-10-8	136	S770PMT-8-8	136	S779AB-6-8	130	SPPH-6	150
S768PMT-12-6	136	S771AB-4-2	130	S779AB-8-4	130	SPPH-8	150
S768PMT-12-8	136	S771AB-4-4	130	S779AB-8-6	130	SPPH-12	150
S768PMT-12-12	136	S771AB-6-4	130	S779AB-8-8	130	SPRB-4-2	152
S768PMT-532-1	136	S771AB-6-6	130	S779AB-10-6	130	SPRB-6-2	152
S768PMT-532-2	136	S771AB-8-4	130	S779AB-10-8	130	SPRB-6-4	152
S768PMT-532-4	136	S771AB-8-6	130	S786PMTBH-4-2	135	SPRB-8-2	152
S769AB-4-2	129	S771AB-8-8	130	S786PMTBH-4-4	135	SPRB-8-4	152
S769AB-4-4	129	S771AB-10-8	130	S786PMTBH-6-4	135	SPRB-8-6	152
S769AB-4-6	129	S771PMT-4-2	138	S786PMTBH-6-6	135	SPRB-12-2	152
S769AB-6-2	129	S771PMT-4-4	138	S786PMTBH-8-6	135	SPRB-12-4	152
S769AB-6-4	129	S771PMT-4-6-4	138	S786PMTBH-8-8	135	SPRB-12-6	152
S769AB-6-4L	129	S771PMT-5/32-1	138	S798YPMT-4-2	137	SPRB-12-8	152
S769AB-6-6	129	S771PMT-6-4	138	S798YPMT-4-4	137	SPRB-16-12	152
S769AB-6-8	129	S771PMT-6-6	138	S798YPMT-6-4	137	SV401-2	186
S769AB-8-4	129	S771PMT-6-8	138	S977PMT-4	134	SV401-4	186
S769AB-8-6	129	S771PMT-8-4	138	S977PMT-4-4	134	SV401-6	186
S769AB-8-6L	129	S771PMT-8-4-8	138	S977PMT-6	134	SV402-2	186
S769AB-8-8	129	S771PMT-8-6	138	S977PMTNS-4	134	SV402-4	186
S769AB-10-6	129	S771PMT-8-8	138	S977PMTNS-4-4	134	SV402-6	186
S769AB-10-8	129	S771PMT-532-2	138	S977PMTNS-6	134	SV404P-6-6	183
S769AB-10-12	129	S771PMT-532-4	138	S977PMTNS-6-6	134	SV404P-10-6	183
S769AB-12-8	129	S772AB-4-2	130	S983PMT-6-8	131	SV404P-10-8	183

SV404P-12-6.....	183	TR103800G8CL.....	339	TS8155-073.....	338	TS-NUT-BR-10.....	190
SV404P-12-8.....	183	TR104000G8CL.....	339	TS8161-11.....	338	TS-NUT-BR-12.....	190
SV404PH-6-6.....	183	TR104200G8CL.....	339	TS8161-12.....	338	TS-NUT-BR-16.....	190
SV404PH-10-6.....	183	TR104800G8CL.....	339	TS8161-13.....	338		
SV405P-6-6.....	183	TR121200G8CL.....	339	TS8161-14.....	338	V	
SV405P-6-8.....	183	TR121400G8CL.....	339	TS8161-15.....	338	VCA029.....	25
SV405P-8-8.....	183	TR121600G8CL.....	339	TS8161-18.....	338	VMC12.....	81
SV406P-4.....	182	TR121800G8CL.....	339	TS8161-122.....	338	VMC14.....	81
SV406P-6.....	182	TR122000G8CL.....	339	TS8163-14.....	338	VMC34.....	81
SV407P-4.....	182	TR122200G8CL.....	339	TS8164-10.....	338	VMC38.....	81
SV407P-6.....	182	TR122400G8CL.....	339	TS8165-12.....	338	VMC58.....	81
SV500P-4.....	182	TR122600G8CL.....	339	TS8165-14.....	338	VMC78.....	81
SV500P-6.....	182	TR122800G8CL.....	339	TS8168-082.....	338	VMC100.....	81
SV500P-8.....	182	TR123000G8CL.....	339	TS8175-104.....	338	VMC100W.....	81
SV500P-12.....	182	TR123200G8CL.....	339	TS8178-126.....	338	VMC114.....	81
SV500P-16.....	182	TR123400G8CL.....	339	TS8187-154.....	338	VMC134.....	81
SV590PH-6.....	182	TR123600G8CL.....	339	TS8253-05.....	338	VMC316.....	81
SV590PH-8.....	182	TR123800G8CL.....	339	TS8254-10.....	338	VMC516.....	81
SV601-2.....	186	TR124000G8CL.....	339	TS8255-05.....	338	VMC1116.....	81
SV601-4.....	186	TR124200G8CL.....	339	TS8267-153.....	338		
SV601-6.....	186	TR124400G8CL.....	339	TS8286-134.....	338	Y	
SV601-8.....	186	TR141800G8CL.....	339	TS8287-11.....	338	Y-9.....	179
SVC206-4-2.....	186	TR142000G8CL.....	339	TS8287-14.....	338		
SVC206-4-4.....	186	TR142400G8CL.....	339	TS8353-15.....	338		
SVC206-6-4.....	186	TR142600G8CL.....	339	TS8354-10.....	338		
SVC406P-4.....	182	TR142800G8CL.....	339	TS8362-19F.....	338		
SVC406P-6.....	182	TR143000G8CL.....	339	TS8363-15N.....	338		
SVC407P-4.....	182	TR143200G8CL.....	339	TS8375-154.....	338		
SVC407P-6.....	182	TR143400G8CL.....	339	TS8394-192S.....	338		
		TR143600G8CL.....	339	TS82586-154.....	338		
T		TR143800G8CL.....	339	TS-COL-BR-03.....	190		
TR081400G5CL.....	339	TR144000G8CL.....	339	TS-COL-BR-04.....	190		
TR081500G5CL.....	339	TR144200G8CL.....	339	TS-COL-BR-05.....	190		
TR081600G5CL.....	339	TR144400G8CL.....	339	TS-COL-BR-06.....	190		
TR081800G5CL.....	339	TR144800G8CL.....	339	TS-COL-BR-08.....	190		
TR082000G5CL.....	339	TR145400G8CL.....	339	TS-COL-BR-10.....	190		
TR082200G5CL.....	339	TR162800G8CL.....	339	TS-COL-BR-12.....	190		
TR082400G5CL.....	339	TR163000G8CL.....	339	TS-COL-BR-16.....	190		
TR083000G5CL.....	339	TR163200G8CL.....	339	TS-INS-BR-03JIC.....	190		
TR091400G5CL.....	339	TR163600G8CL.....	339	TS-INS-BR-04JIC.....	190		
TR091600G5CL.....	339	TR163800G8CL.....	339	TS-INS-BR-04MP.....	190		
TR091800G5CL.....	339	TR183800G8CL.....	339	TS-INS-BR-04X03MP.....	190		
TR092000G5CL.....	339	TR184200G8CL.....	339	TS-INS-BR-05JIC.....	190		
TR092200G5CL.....	339	TS5161-12.....	338	TS-INS-BR-05MP.....	190		
TR092400G5CL.....	339	TS5161-13.....	338	TS-INS-BR-06JIC.....	190		
TR092600G5CL.....	339	TS5161-14.....	338	TS-INS-BR-06MP.....	190		
TR092800G5CL.....	339	TS5161-16.....	338	TS-INS-BR-06X04MP.....	190		
TR093000G5CL.....	339	TS5163-14.....	338	TS-INS-BR-08JIC.....	190		
TR093200G5CL.....	339	TS5165-12.....	338	TS-INS-BR-08MP.....	190		
TR093400G5CL.....	339	TS5165-14.....	338	TS-INS-BR-08X06MP.....	190		
TR101600G8CL.....	339	TS5165-15.....	338	TS-INS-BR-10JIC.....	190		
TR101800G8CL.....	339	TS5165-16.....	338	TS-INS-BR-10MP.....	190		
TR102000G8CL.....	339	TS5165-18.....	338	TS-INS-BR-12JIC.....	190		
TR102200G8CL.....	339	TS8145-076.....	338	TS-INS-BR-12MP.....	190		
TR102400G8CL.....	339	TS8151-10.....	338	TS-INS-BR-16JIC.....	190		
TR102600G8CL.....	339	TS8151-12.....	338	TS-INS-BR-16MP.....	190		
TR102800G8CL.....	339	TS8151-14.....	338	TS-NUT-BR-03.....	190		
TR103000G8CL.....	339	TS8151-16.....	338	TS-NUT-BR-04.....	190		
TR103200G8CL.....	339	TS8151-18.....	338	TS-NUT-BR-05.....	190		
TR103400G8CL.....	339	TS8154-10.....	338	TS-NUT-BR-06.....	190		
TR103600G8CL.....	339	TS8154-12.....	338	TS-NUT-BR-08.....	190		

3/8" QUICK-FIX® INSTRUCTIONS

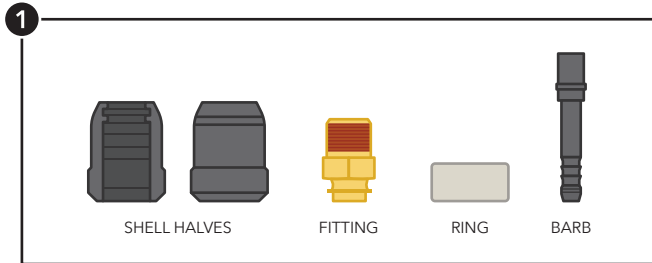

STEP ONE

Disassemble the Quick-Fix Kit

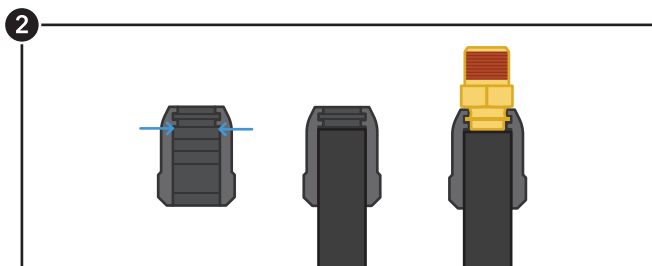

STEP TWO

Place squarely trimmed hose flush against the groove inside one shell half (see arrows) then insert fitting into lock groove

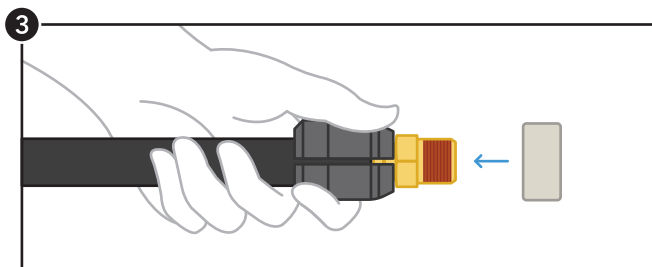

STEP THREE

Place other shell half over the hose and fitting. Holding the shells in place, slide the ring over, pushing and turning into place

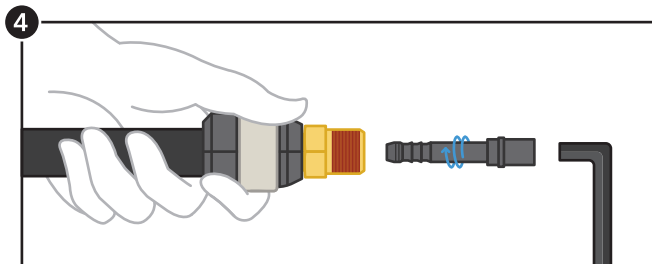

STEP FOUR

Insert barb into fitting, pushing and turning to start the threads. Using the supplied wrench (5/16" hex key), continue to push and turn barb

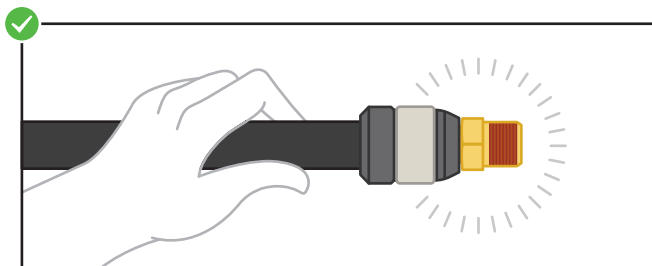

DONE!

Once the barb is flush inside the fitting, your hose end is complete and ready for installation

NOTE: Visually check the final assembly to insure the hose has not shifted position

1/2" QUICK-FIX® INSTRUCTIONS

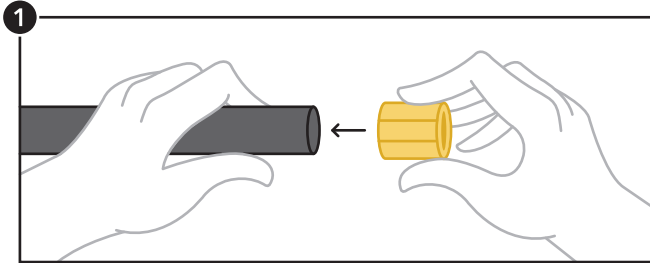

STEP ONE

Trim the hose end square and push the sleeve onto the end until flush

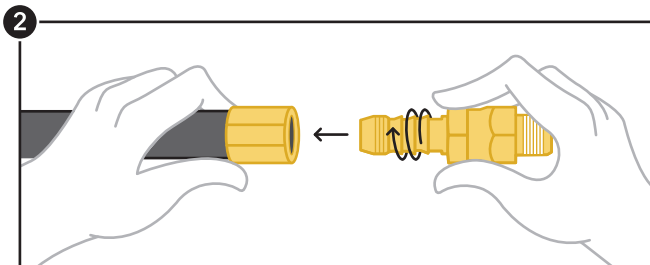

STEP TWO

Place greased barb into sleeve, pushing and turning the barb to start the threads

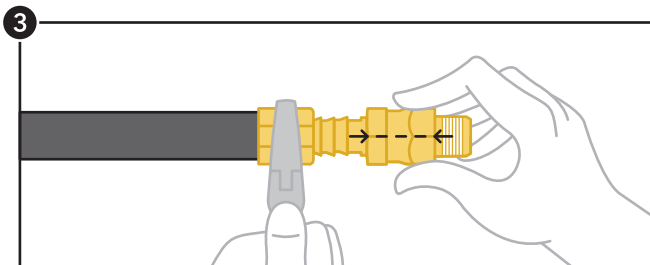

STEP THREE

Holding sleeve in place (a wrench may be necessary), align the barb and swivel hexes

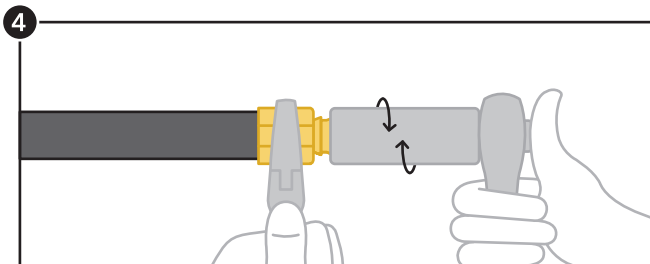

STEP FOUR

Continue to hold sleeve and place a 7/8" deep well socket over swivel hex and onto barb hex. Screw the barb hex in using a socket or crescent wrench

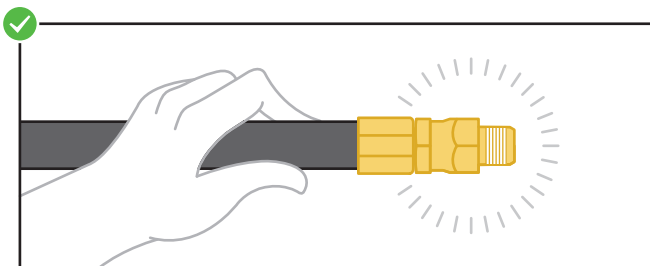

DONE!

Once the barb hex is flush to the top of the sleeve, your hose end is complete and ready for installation

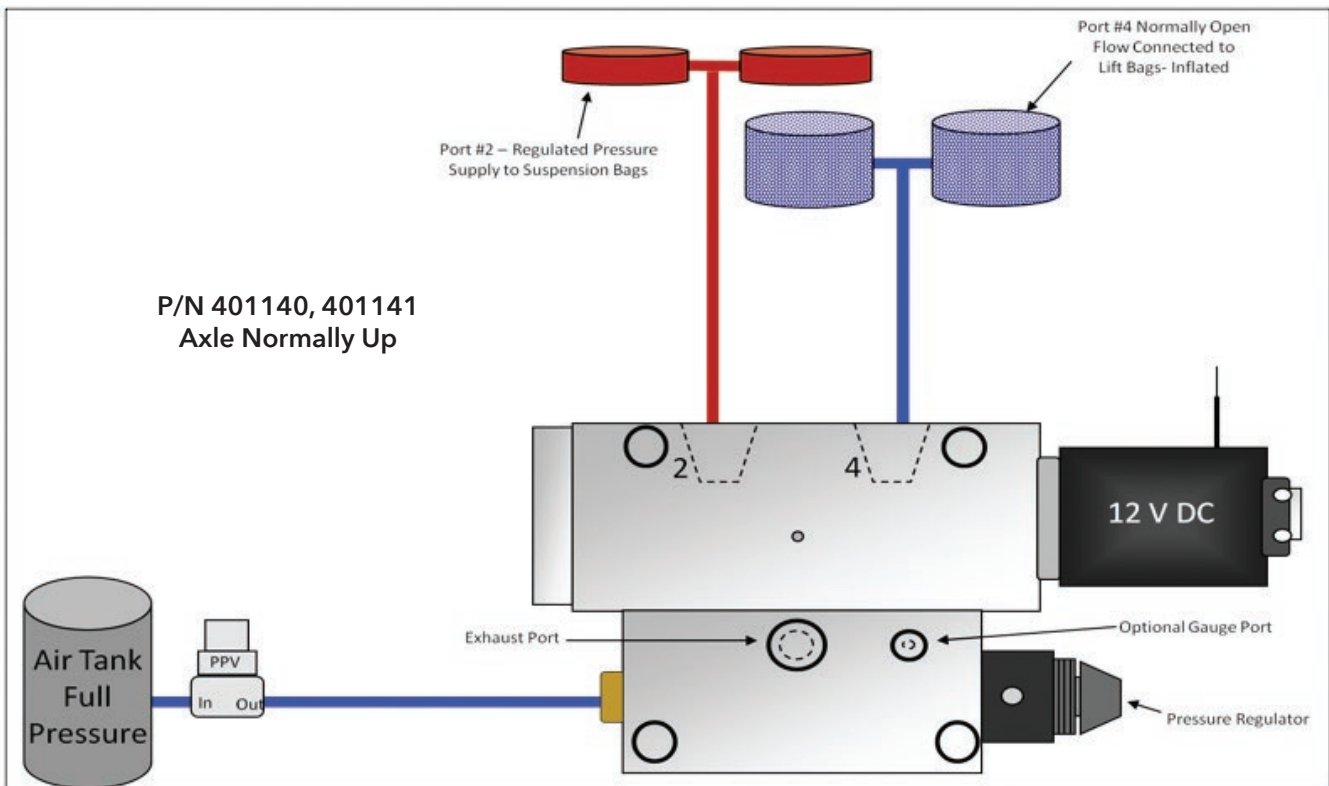
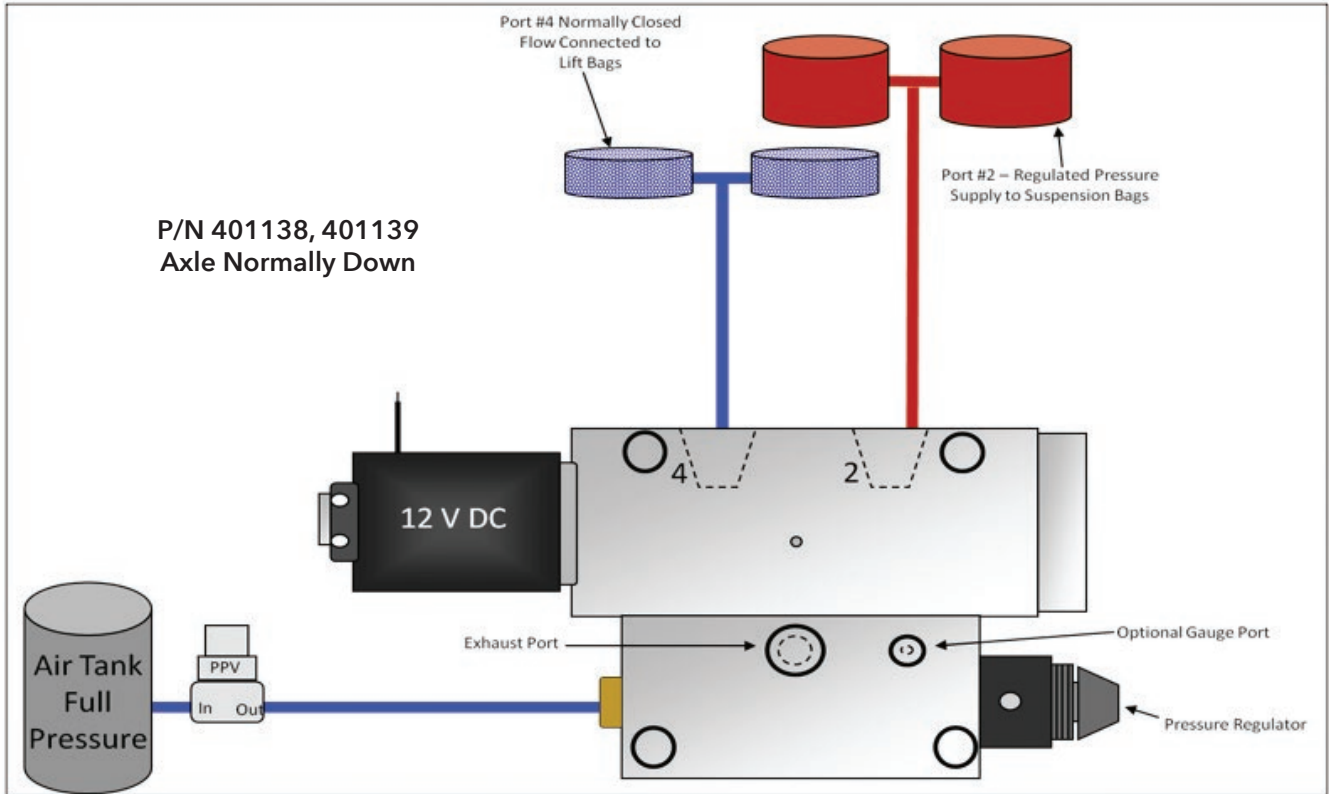

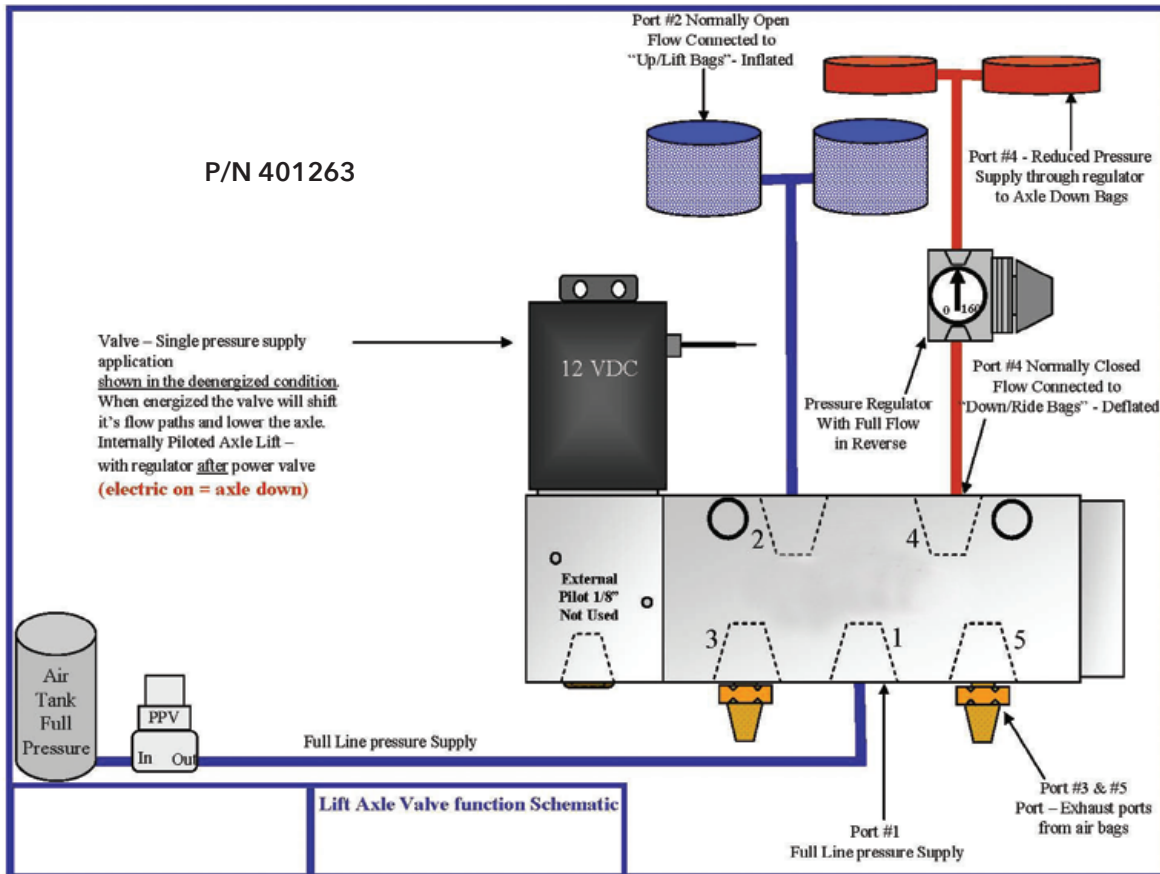
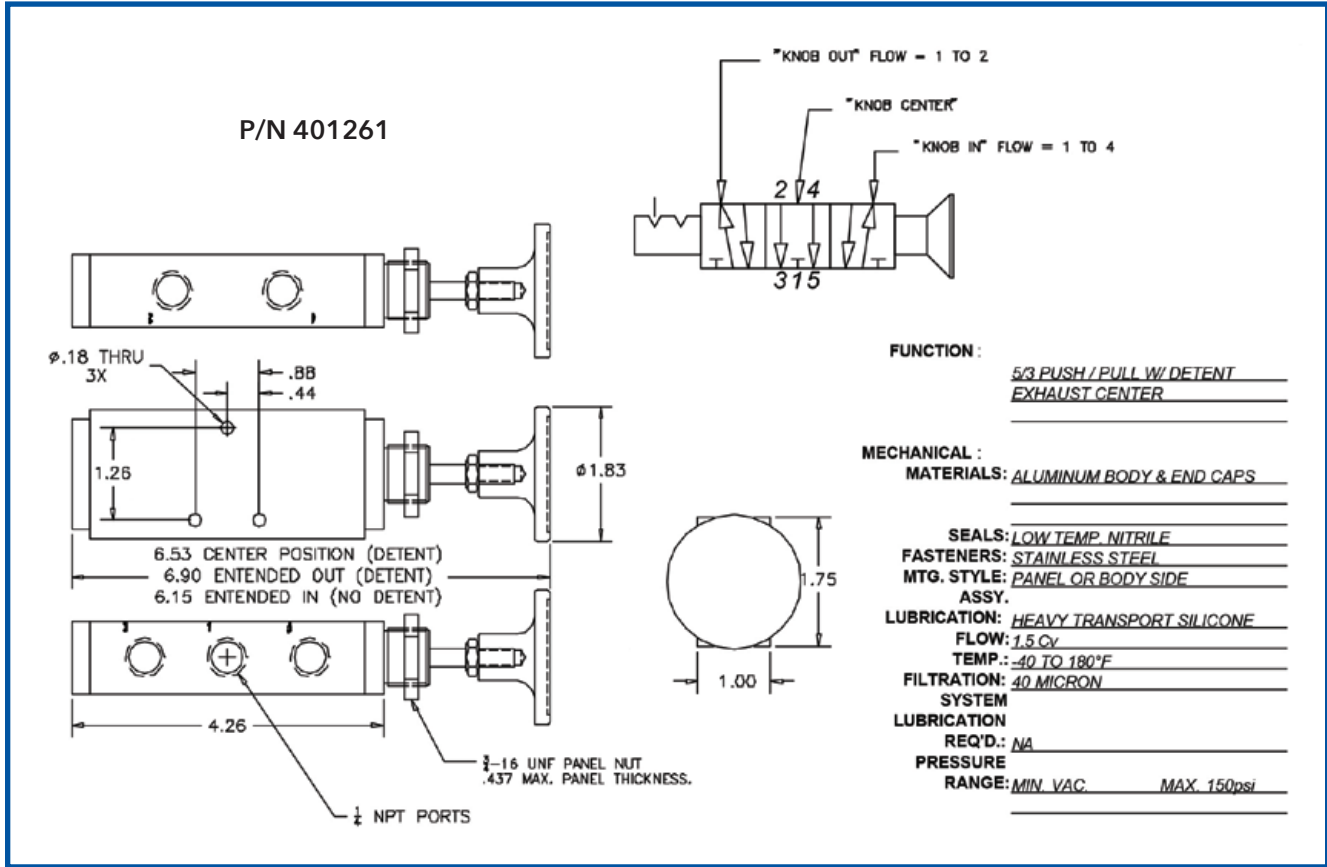

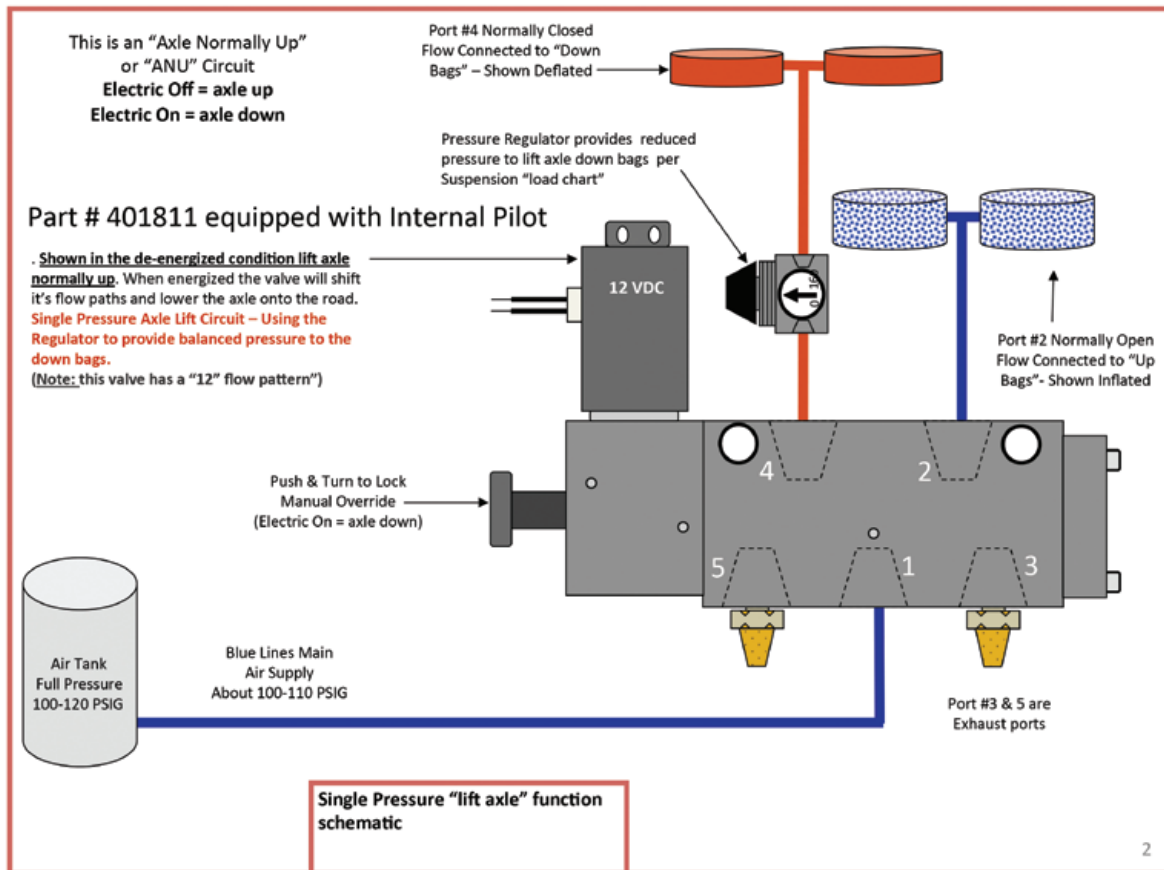
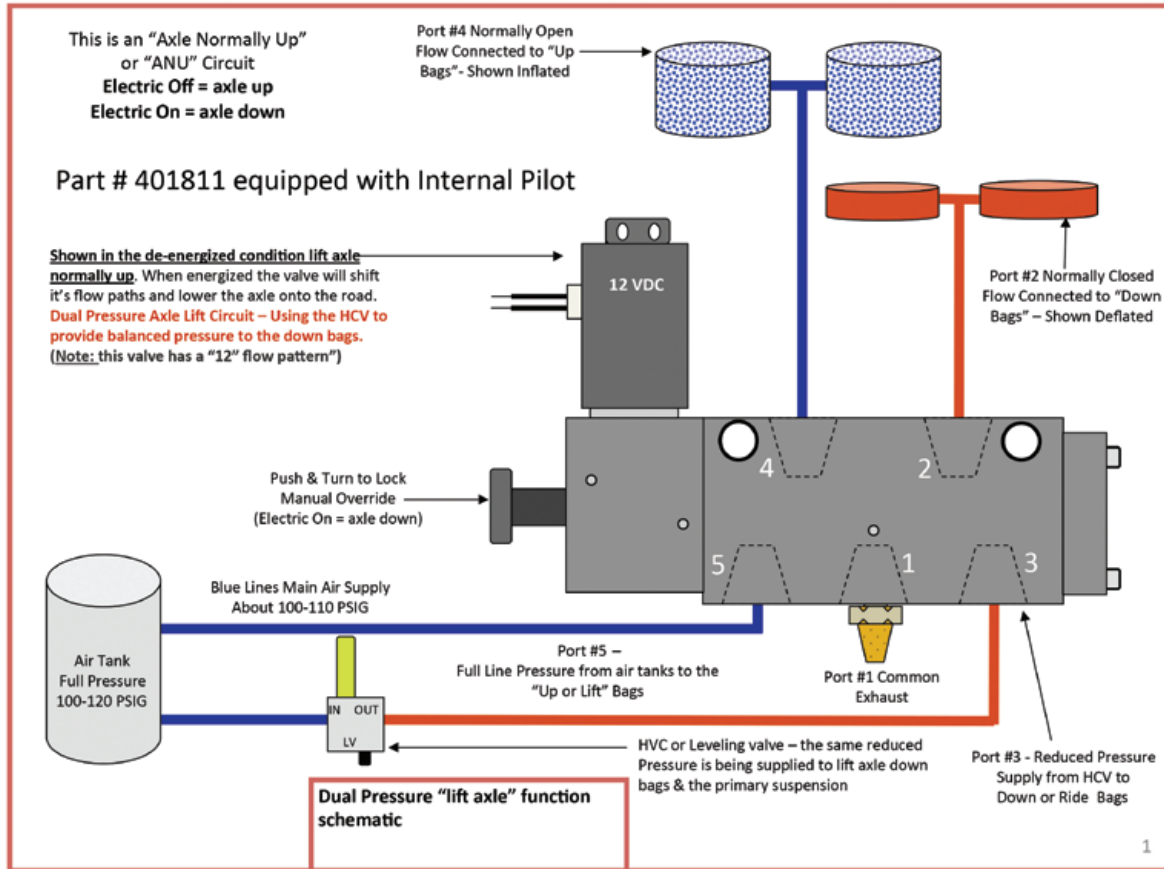

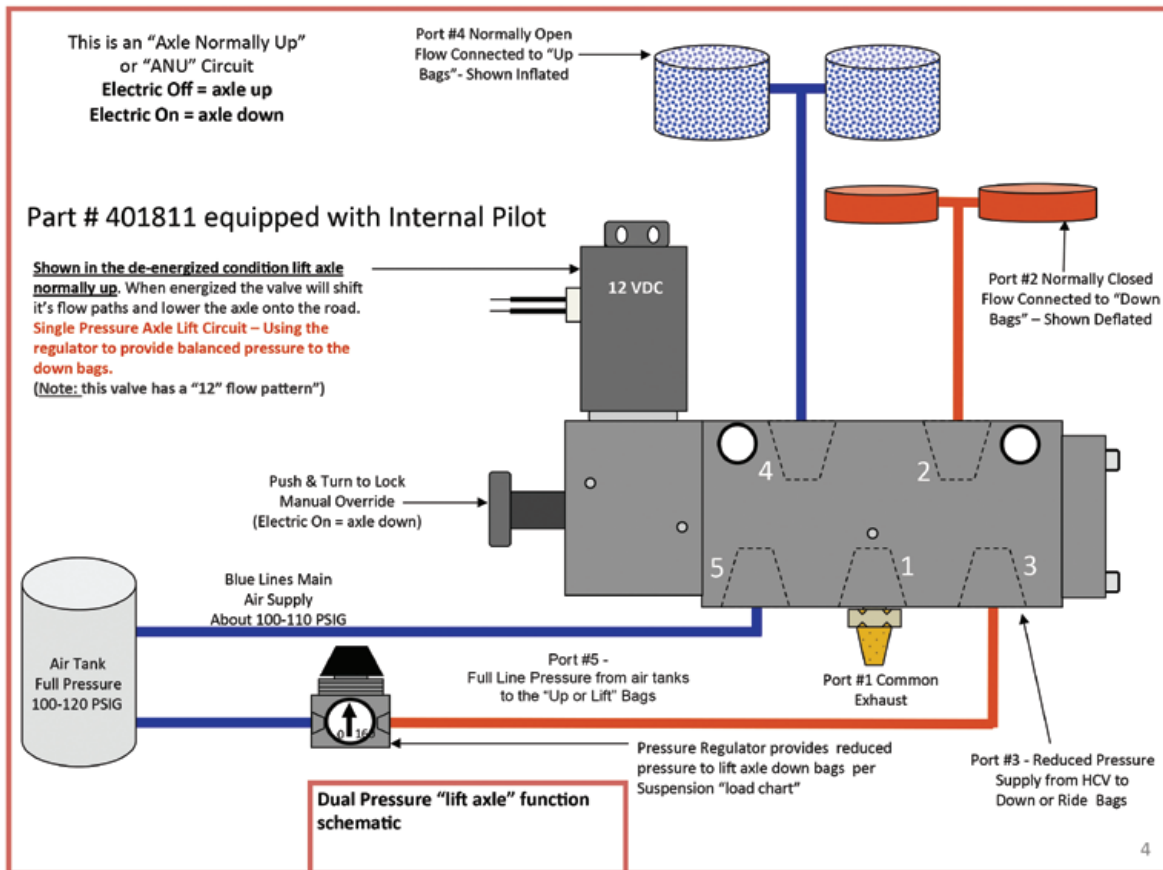
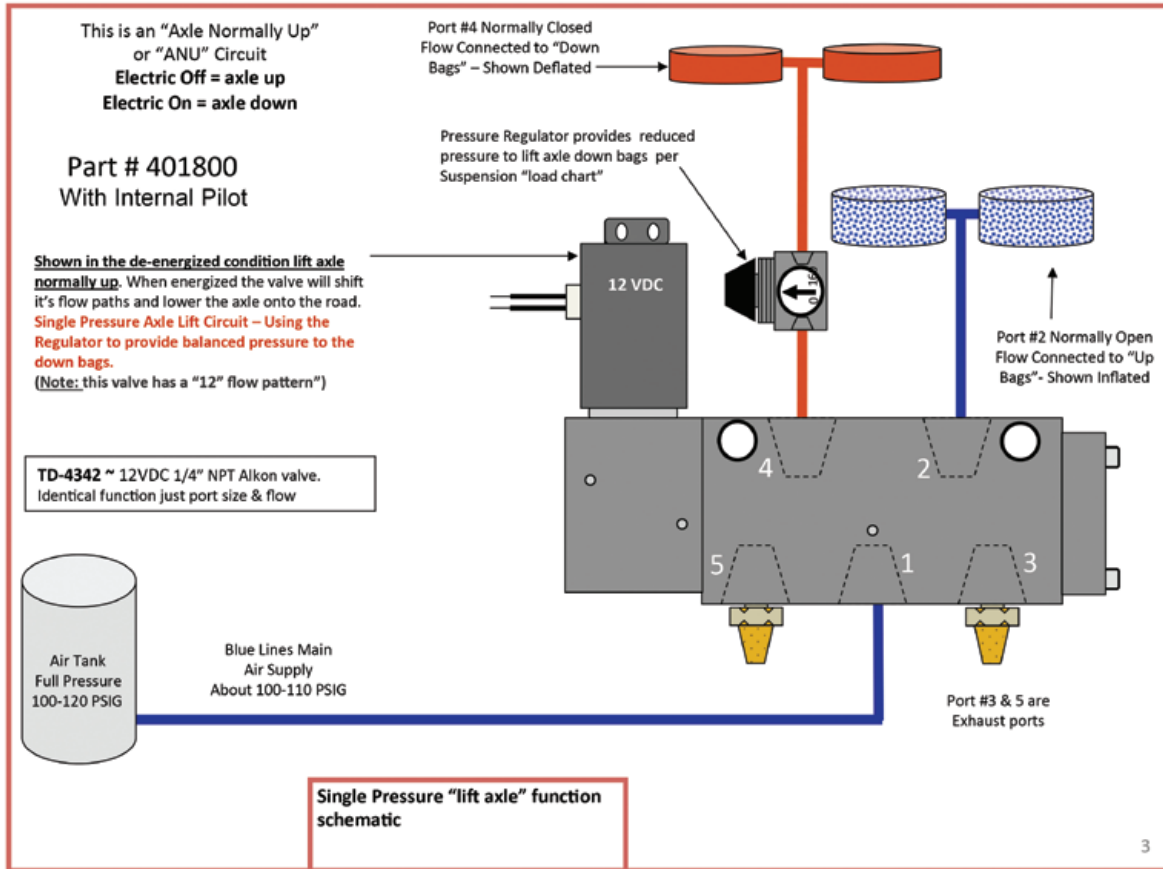

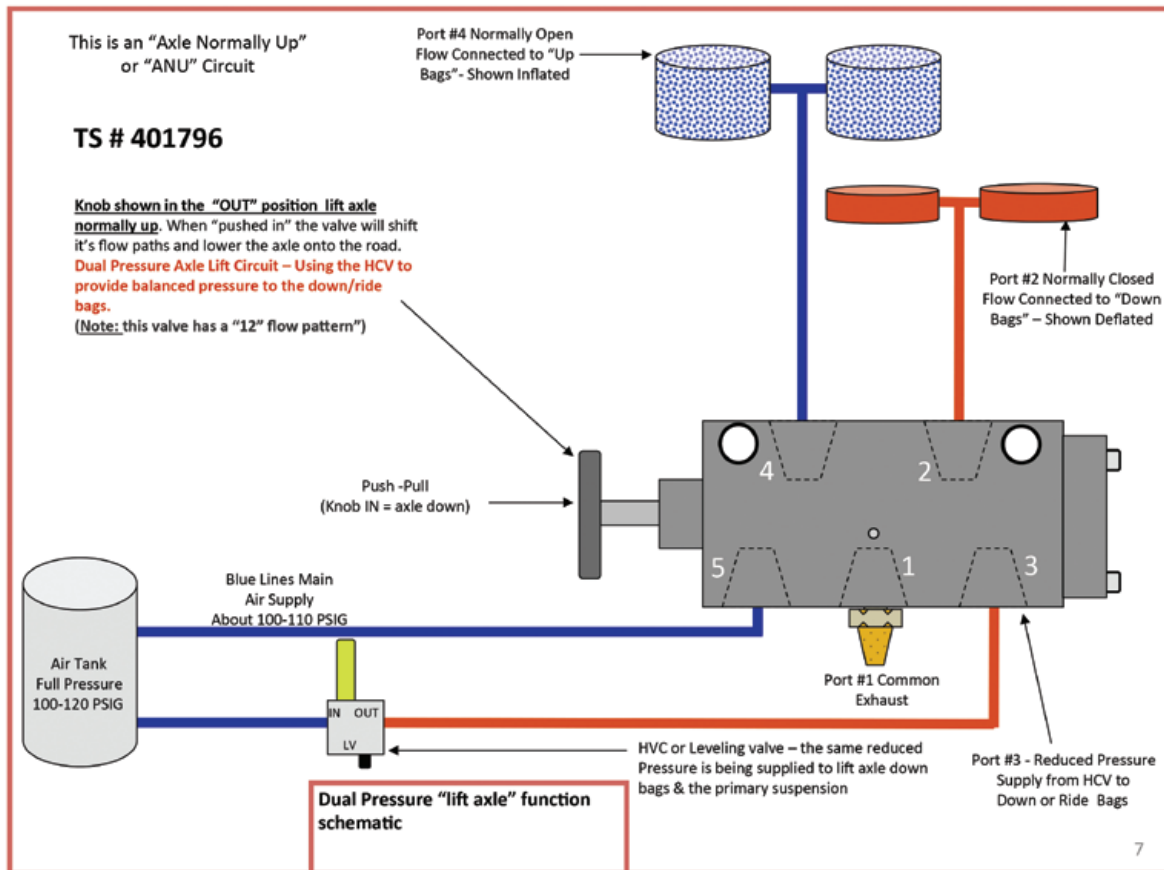
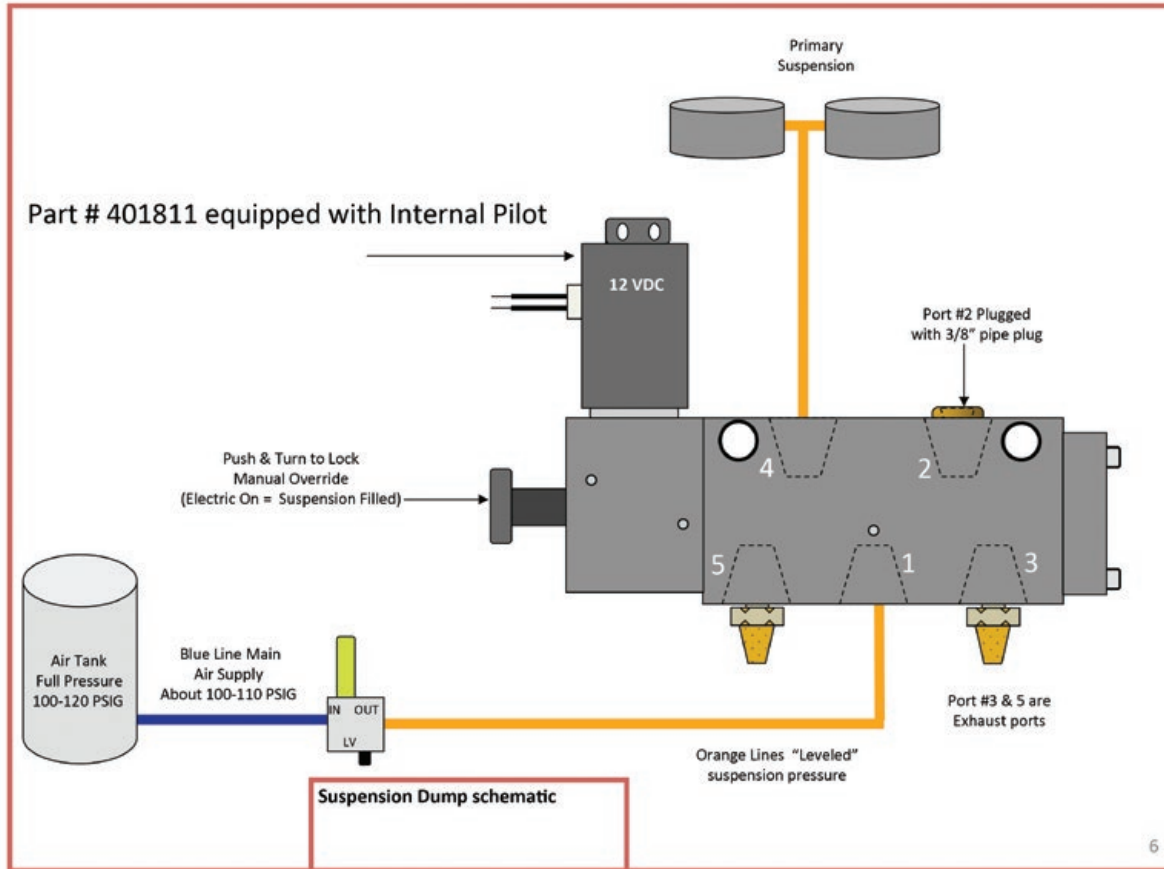

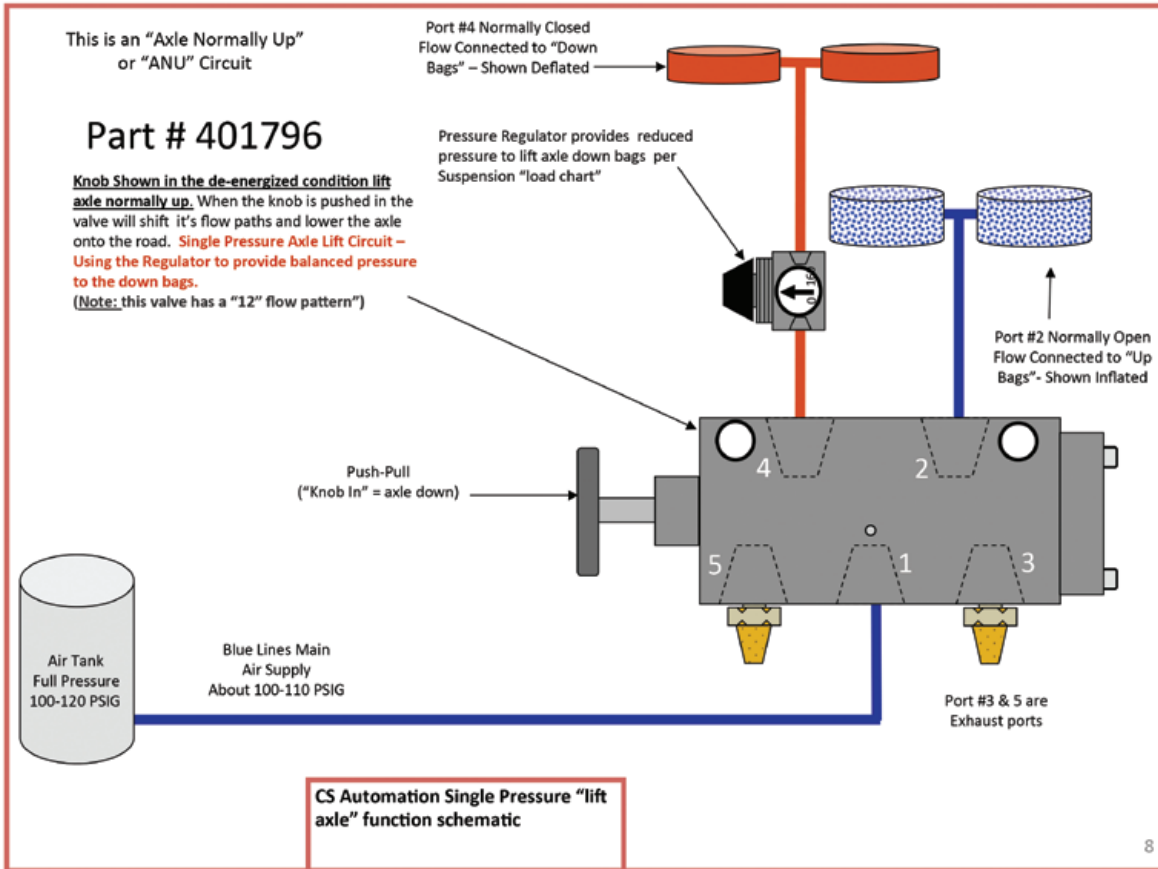

8

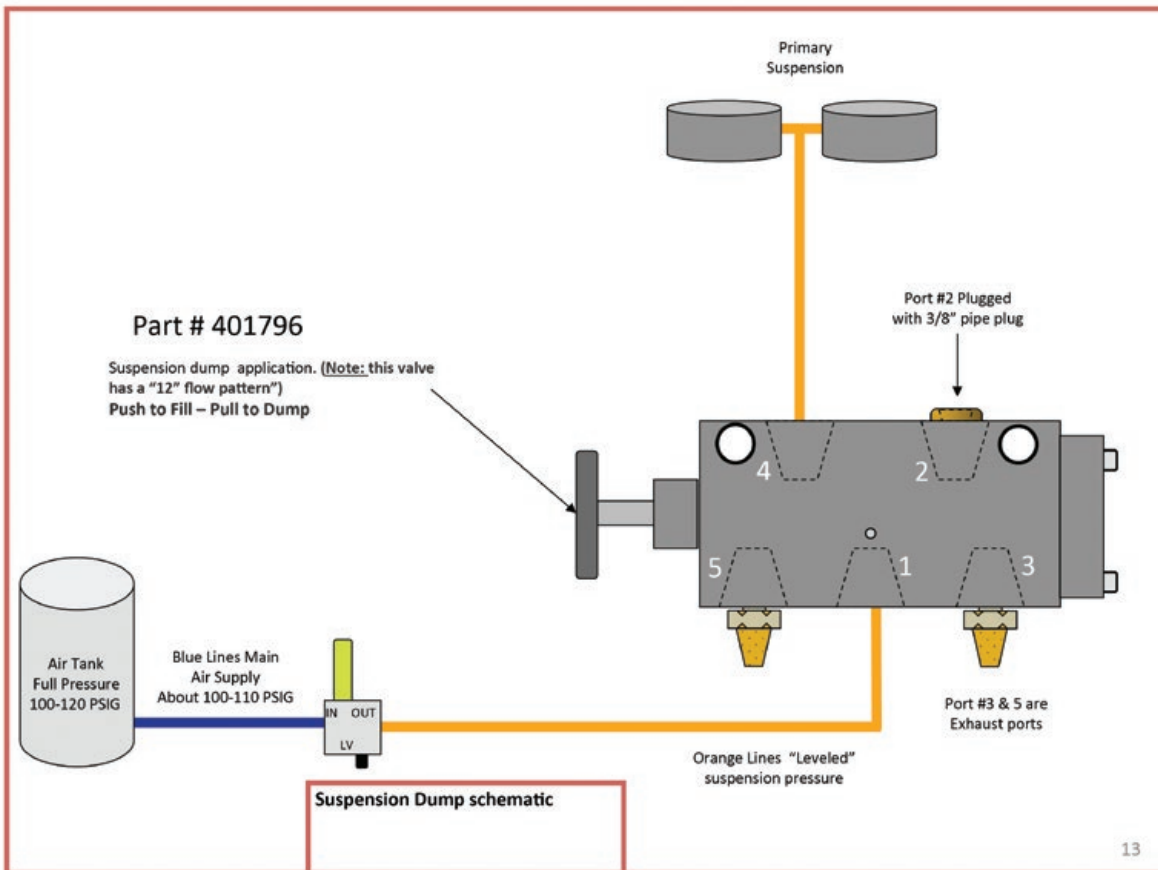

13

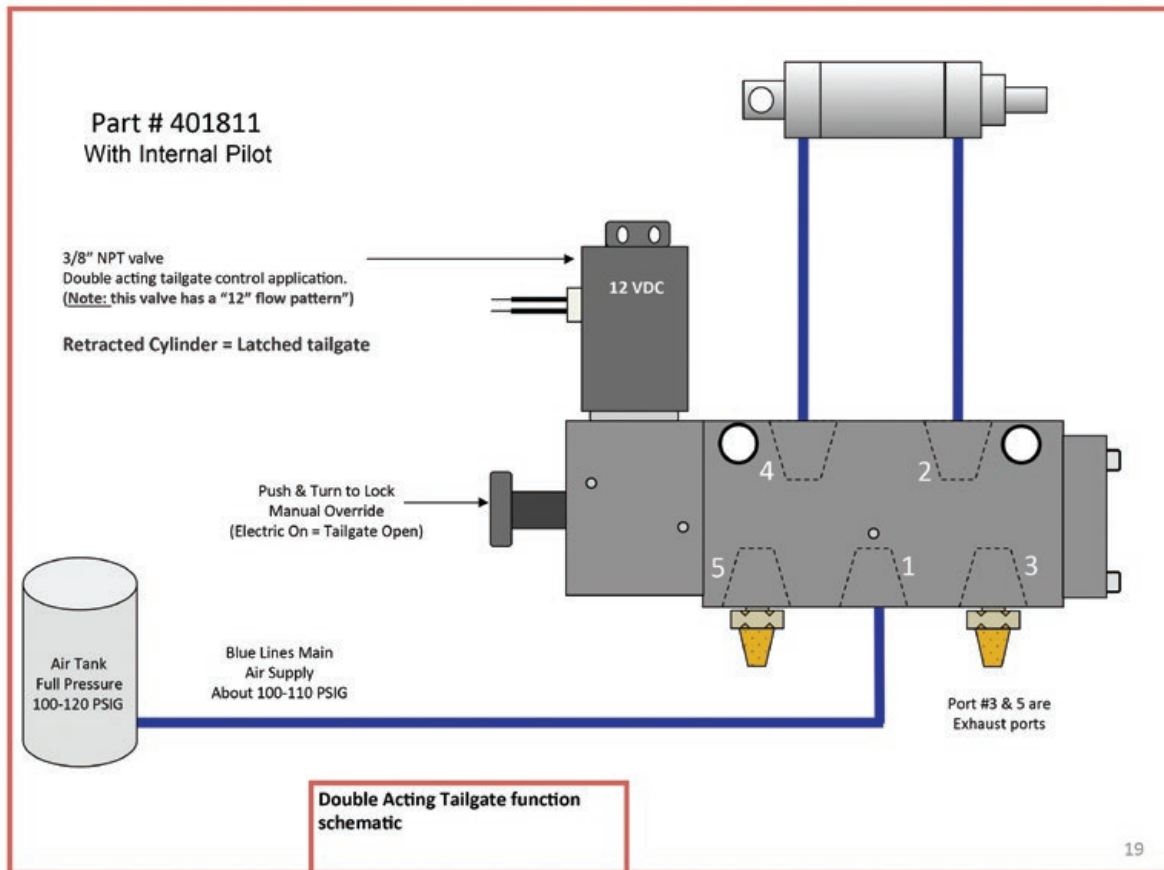
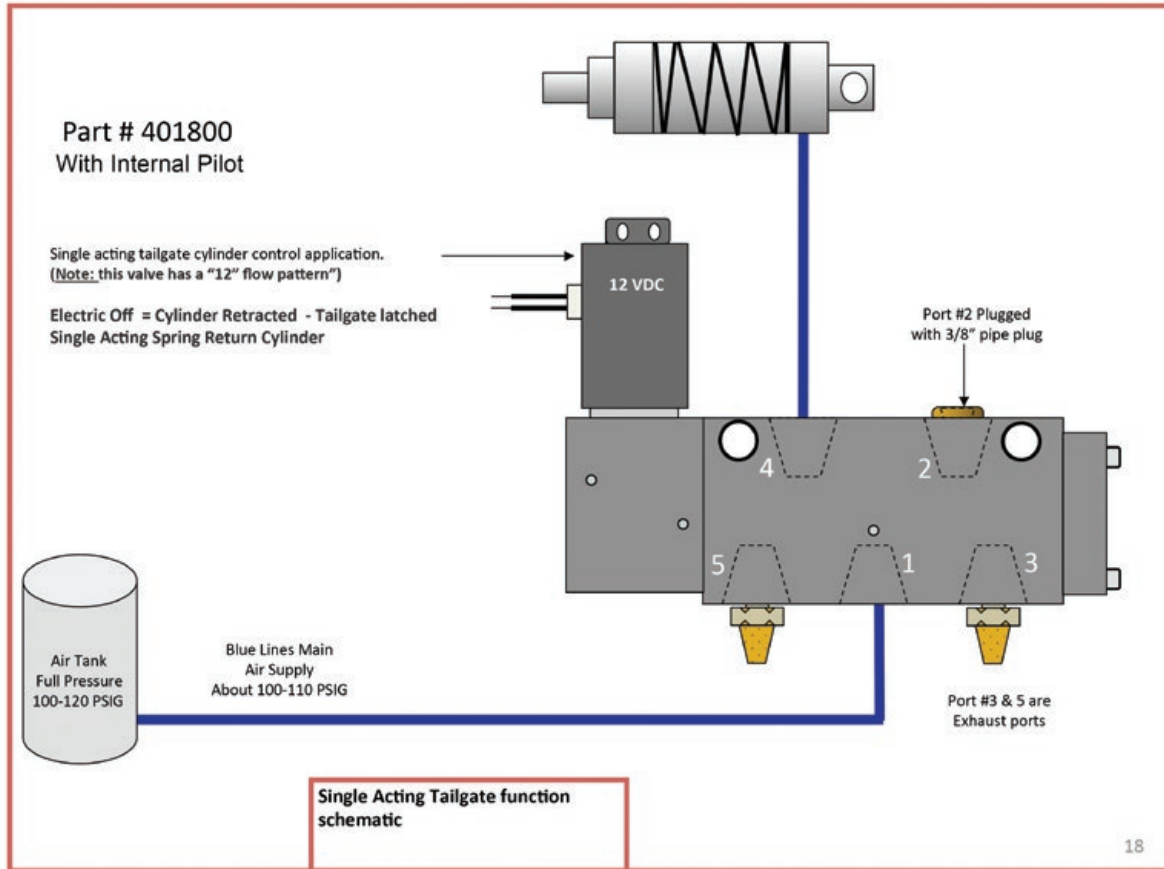

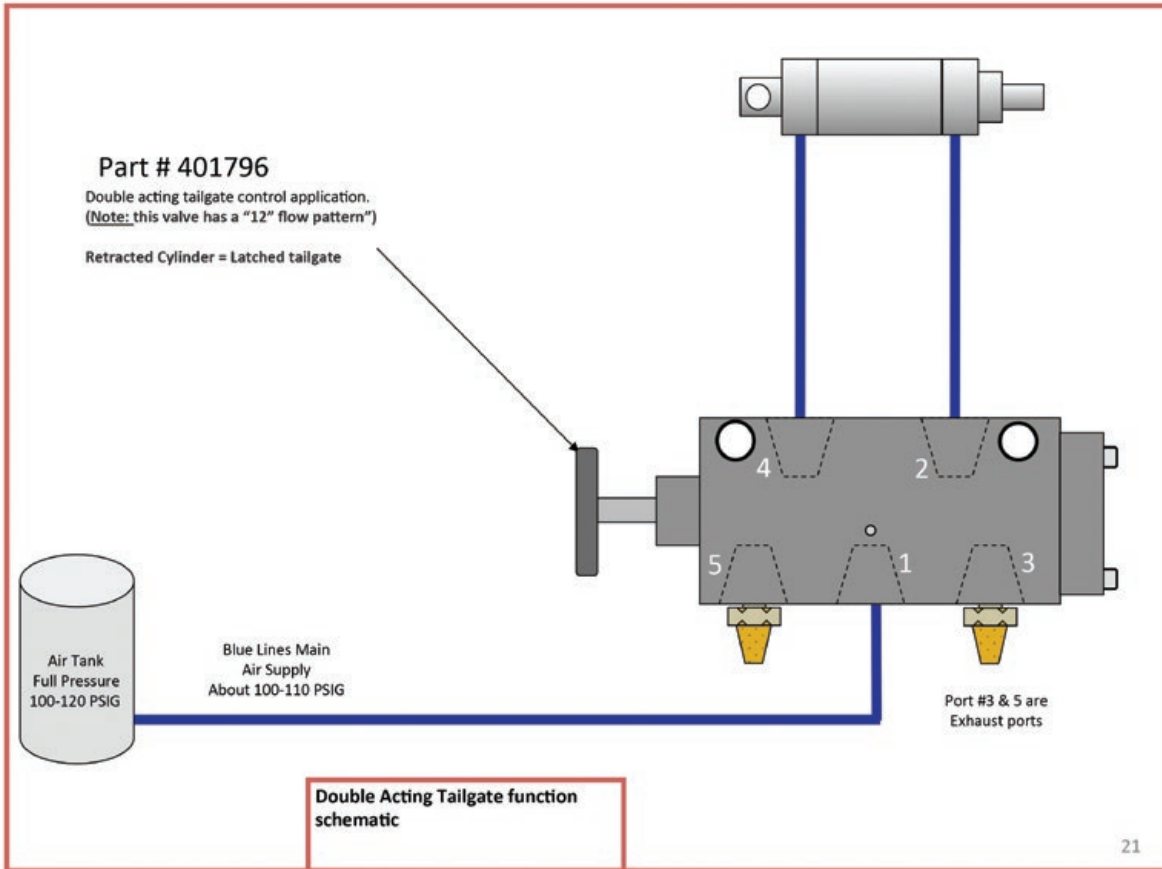
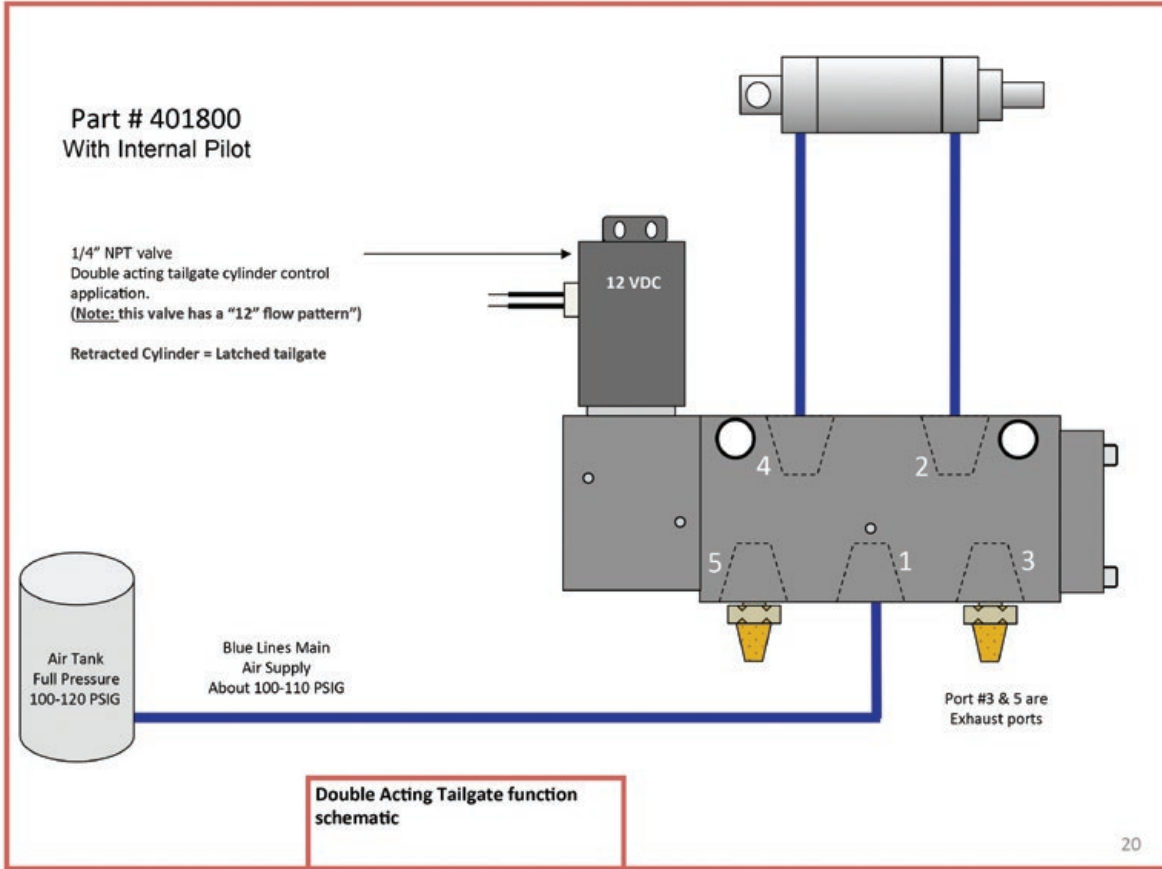

P/N 401798

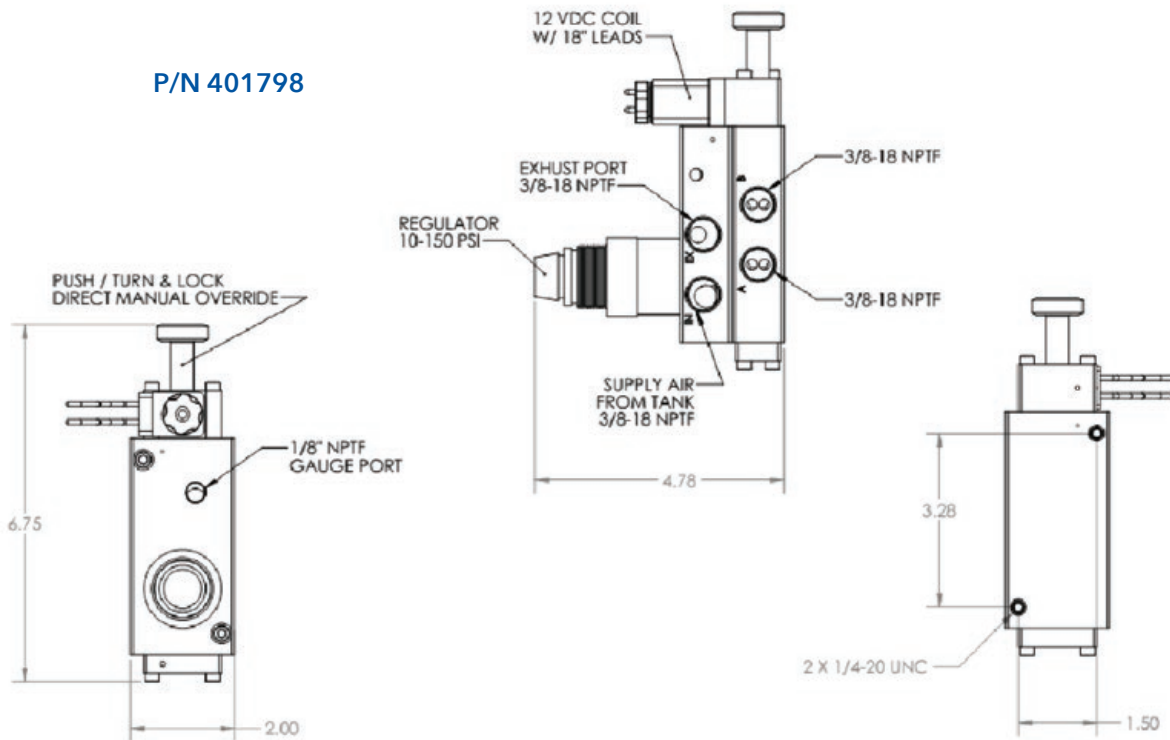

7/8 - 14 PANEL MOUNT THREAD

1-1/4" HEX LOCKNUT 2-PCS.

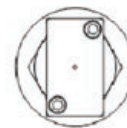
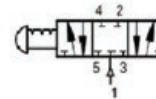
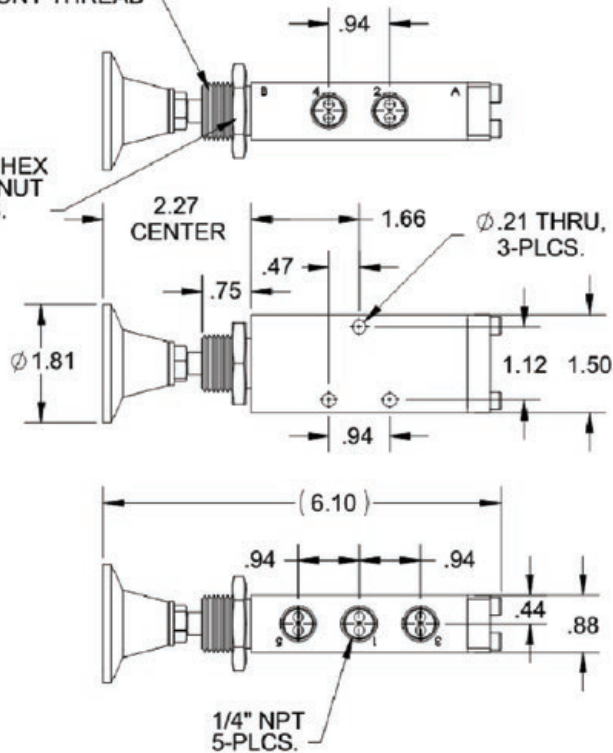

P/N 401801

SPECIFICATIONS:

1. VALVE IS BLACK ANODIZED.
2. 3-POSITION VALVE
3. CENTER POSITION, ALL PORTS BLOCKED.
4. TEMP: -40°F TO +180°F
5. PRESSURE: 150 PSI MAX

TEV & STEV TRAILER AIR BRAKE SYSTEMS

COMPETITIVE REPLACEMENT

The replacement of competitive systems with the TEV or STEV requires that the reservoir port of the TEV or STEV valve be nipple mounted on the trailer tank. Either tank may be used on a two tank trailer (only one tank is now required on single axle trailers). If two tanks are used, they should be connected by 1/2" O.D. tubing at their end ports. In systems with dual compartment reservoirs, the compartments should be treated as separate tanks and be connected by 1/2" O.D. tubing.

The accompanying schematics provide a guide for system retro-fit. Many more systems are in use than can be shown here. Contact Tramec Sloan product support for specific applications that are not shown.

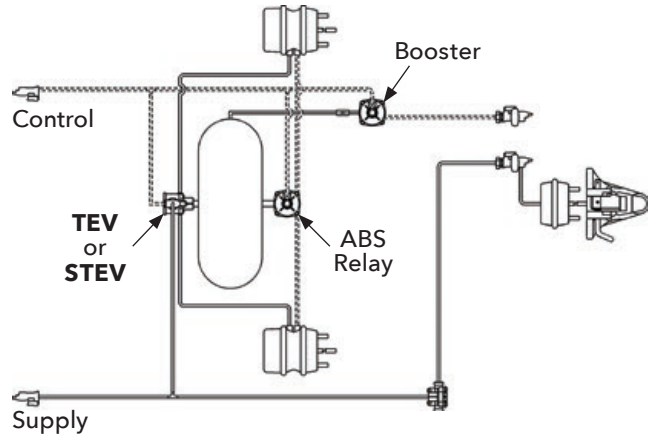

TEV & STEV System
Typical Single Axle Trailer

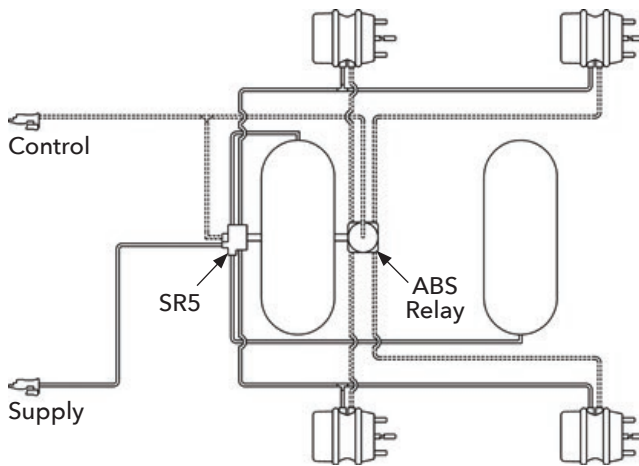

SR5 System

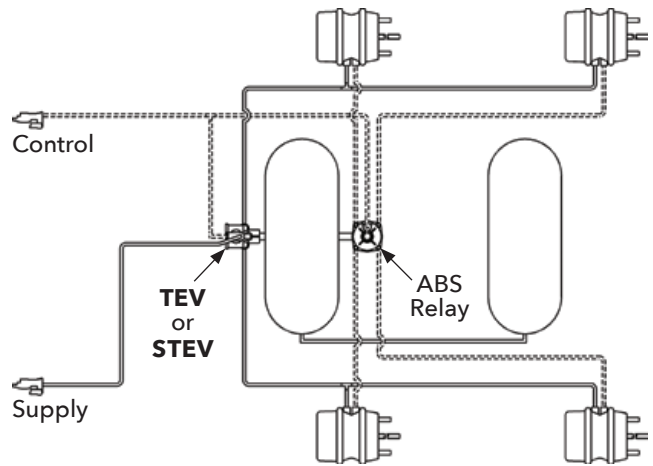

TEV & STEV System

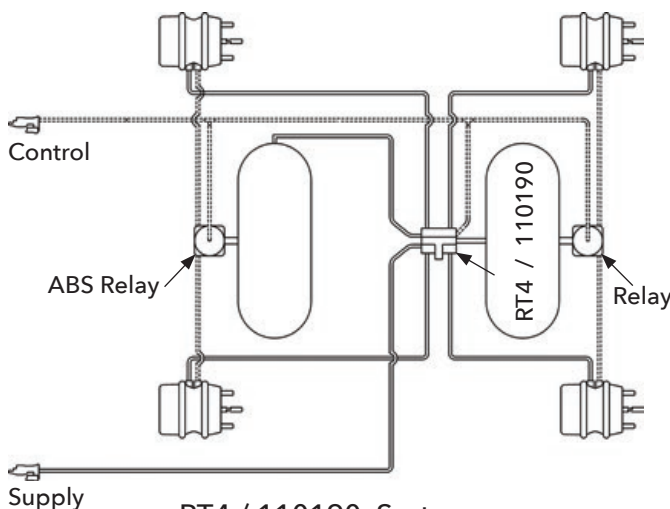

RT4 / 110190 System

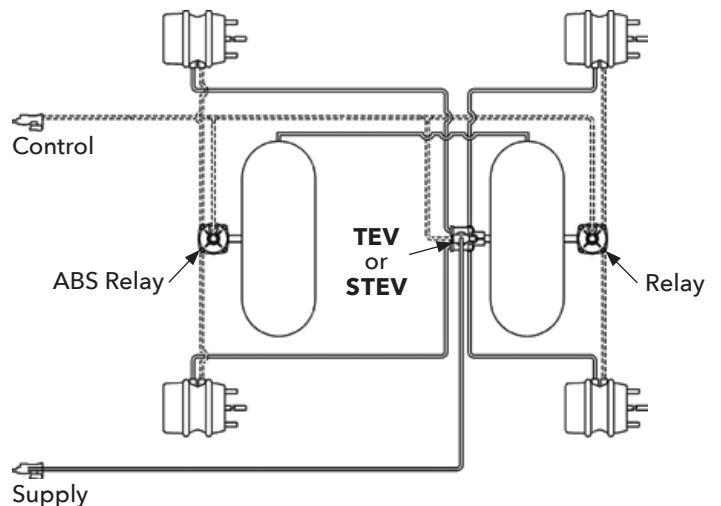

TEV & STEV System

TRAMECSLOAN.COM
800.336.7778

- 3-in-1 Wraps
- Coiled Air
- Hose Assemblies
- Gladhands
- Air Tanks
- Air Brake Valves
- Quick-Fix® Kits
- Brass Fittings
- Composite Fittings
- Fasteners
- ABS Cables
- Receptacles & Sockets
- Bulk Wire & Cable
- Electrical Connectors
- Switches & Toggles
- Wiper Blades
- Water Pumps
- Fuel Caps
- Hose Clamps
- And More!

